

SHARP PARTS GUIDE

No. S76V5LC46XD1E

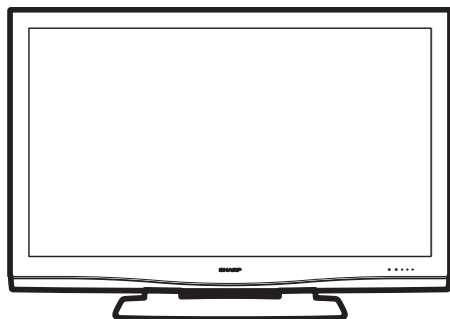

LCD COLOUR TELEVISION MODELS **LC-46XD1E/RU** **LC-52XD1E/RU**

CONTENTS

- | | |
|---|---|
| [1] PRINTED WIRING BOARD ASSEMBLYS | [7] DIGITAL Unit (DUNTKD833FM02) |
| [2] LCD Panel AND TUNER (NOTE: THE PARTS HERE SHOWN ARE SUPPLIED AS AN ASSEMBLY BUT NOT INDEPENDENTLY.) | [8] DUNTKD910FM01 (KEY Unit) |
| [3] DUNTKD915FM01 (MAIN Unit) | [9] DUNTKD909FM01 (R/C Unit) |
| [4] DUNTKD604FM11 (AV UNIT) | [10] CABINET PARTS |
| [5] RDENCA204WJQZ (POWER Unit) | [11] SUPPLIED ACCESSORIES |
| [6] DUNTKD833FM02 (D-TUNER Unit) | [12] PACKING PARTS (NOT REPLACEMENT ITEM) |
| | [13] SERVICE JIGS (USER FOR SERVICING) |

Parts marked with "▲" are important for maintaining the safety of the set. Be sure to replace these parts with specified ones for maintaining the safety and performance of the set.

SHARP CORPORATION

This document has been published to be used for after sales service only.
The contents are subject to change without notice.

NO.	PARTS CODE	PRICE RANK	NEW MARK	PART DELIVERY	DESCRIPTION
[1] PRINTED WIRING BOARD ASSEMBLYS					
	DUNTKD915FM01		N	R	Main PWB Unit
	DUNTKD604FM11		N	R	AV PWB Unit
	RDENCA204WJQZ		N	R	Power PWB Unit
	DUNTKD833FM02			R	D-Tuner PWB Unit
	DUNTKD628FM06		N	R	Digital PWB Unit
	DUNTKD910FM01		N	R	Key PWB Unit
	DUNTKD909FM01			R	R/C PWB Unit
[2] LCD Panel AND TUNER (NOTE: THE PARTS HERE SHOWN ARE SUPPLIED AS AN ASSEMBLY BUT NOT INDEPENDENTLY.)					
	R1LK460D3LZ1AZ		N	R	DISPLAY
	R1LK520D3LZ1A		N	R	DISPLAY
[3] DUNTKD915FM01 (MAIN Unit)					
C1701	VCKYCY1EF104ZY	AA		R	0.1 25V Ceramic
C1702	VCKYCY1HB103KY	AA		R	0.01 50V Ceramic
C1703	VCKYCY1EF104ZY	AA		R	0.1 25V Ceramic
C1704	VCAAPD1AJ686MY	AE		R	68 10V Electrolytic
C1705	VCKYCY1EF104ZY	AA		R	0.1 25V Ceramic
C1706	RC-KZA070WJZZY	AD		R	Capacitor
C1707	VCKYCY1EF104ZY	AA		R	0.1 25V Ceramic
C1708	VCKYTV1CB105KY	AC		R	1 16V Ceramic
C1709	VCKYCY1EF104ZY	AA		R	0.1 25V Ceramic
C1710	VCKYCY1EF104ZY	AA		R	0.1 25V Ceramic
C1711	RC-KZA073WJZZY	AD		R	Capacitor
C1712	VCKYCY1EF104ZY	AA		R	0.1 25V Ceramic
C1713	VCKYCY1EF104ZY	AA		R	0.1 25V Ceramic
C1715	VCEASX1VN226MY	AC		R	22 35V Electrolytic
C1716	VCEASX1CN226MY	AC		R	22 16V Electrolytic
C1717	VCKYCY1HB682KY	AA		R	6800p 50V Ceramic
C1718	VCKYCY1EF104ZY	AA		R	0.1 25V Ceramic
C1719	VCKYCY1EF104ZY	AA		R	0.1 25V Ceramic
C1720	VCEASX1CN226MY	AC		R	22 16V Electrolytic
C1721	VCAAPD1AJ686MY	AE		R	68 10V Electrolytic
C1722	VCKYCY1EF104ZY	AA		R	0.1 25V Ceramic
C1723	RC-KZA073WJZZY	AD		R	Capacitor
C1724	RC-KZA073WJZZY	AD		R	Capacitor
C1725	VCKYCY1EF104ZY	AA		R	0.1 25V Ceramic
C1726	RC-KZA070WJZZY	AD		R	Capacitor
C1727	VCKYCY1EF104ZY	AA		R	0.1 25V Ceramic
C1728	VCKYTV1CB105KY	AC		R	1 16V Ceramic
C1730	VCKYCY1HB332KY	AA		R	3300p 50V Ceramic
C1731	VCKYCY1EF104ZY	AA		R	0.1 25V Ceramic
C1732	VCKYCY1EF104ZY	AA		R	0.1 25V Ceramic
C1733	VCEASX1CN226MY	AC		R	22 16V Electrolytic
C1734	VCKYCY1EF104ZY	AA		R	0.1 25V Ceramic
C1735	VCAAPD1AJ686MY	AE		R	68 10V Electrolytic
C1736	VCKYCY1EF104ZY	AA		R	0.1 25V Ceramic
C1737	RC-KZA073WJZZY	AD		R	Capacitor
C1738	RC-KZA073WJZZY	AD		R	Capacitor
C1739	VCKYCY1EF104ZY	AA		R	0.1 25V Ceramic
C1740	RC-KZA070WJZZY	AD		R	Capacitor
C1741	VCKYCY1EF104ZY	AA		R	0.1 25V Ceramic
C1742	VCKYCY1EF104ZY	AA		R	0.1 25V Ceramic
C1743	VCCCCY1HH220JY	AA		R	22p 50V Ceramic
C1744	VCAAPD1AJ686MY	AE		R	68 10V Electrolytic
C1745	VCCCCY1HH560JY	AB		R	56p 50V Ceramic
C1746	VCEASX0JN476MY	AC		R	47 6.3V Electrolytic
C1747	VCEASX0JN476MY	AC		R	47 6.3V Electrolytic
C1748	VCKYTV1CB105KY	AC		R	1 16V Ceramic
C1749	VCKYCY1EF104ZY	AA		R	0.1 25V Ceramic
C1751	VCKYCY1HB222KY	AA		R	2200p 50V Ceramic
C1752	VCKYCY1EF104ZY	AA		R	0.1 25V Ceramic
C1753	VCAAPD1AJ686MY	AE		R	68 10V Electrolytic
C1754	VCKYCY1EF104ZY	AA		R	0.1 25V Ceramic
C1755	RC-KZA073WJZZY	AD		R	Capacitor
C1756	RC-KZA073WJZZY	AD		R	Capacitor
C1757	VCKYCY1EF104ZY	AA		R	0.1 25V Ceramic
C1758	VCKYCY1EF104ZY	AA		R	0.1 25V Ceramic
C1759	VCKYCY1EF104ZY	AA		R	0.1 25V Ceramic
C1760	VCKYCY1EF104ZY	AA		R	0.1 25V Ceramic
C1761	VCKYCY1EF104ZY	AA		R	0.1 25V Ceramic
C1762	VCKYCY1EF104ZY	AA		R	0.1 25V Ceramic
C1763	VCKYCY1EF104ZY	AA		R	0.1 25V Ceramic
C1764	VCKYCY1EF104ZY	AA		R	0.1 25V Ceramic
C1765	VCEASX1CN226MY	AC		R	22 16V Electrolytic
C1766	VCEASX1CN226MY	AC		R	22 16V Electrolytic
C1767	VCCCCY1HH560JY	AB		R	56p 50V Ceramic
C1768	VCCCCY1HH560JY	AB		R	56p 50V Ceramic
C1769	VCKYCY1HB103KY	AA		R	0.01 50V Ceramic
C1770	VCKYCY1HB103KY	AA		R	0.01 50V Ceramic
C1771	VCKYCY1HB103KY	AA		R	0.01 50V Ceramic
C1772	VCKYCY1HB221KY	AA		R	220p 50V Ceramic
C1773	VCCCCY1HH102JY	AB		R	1000p 50V Ceramic

NO.	PARTS CODE	PRICE RANK	NEW MARK	PART DELIVERY	DESCRIPTION
[3] DUNTKD915FM01 (MAIN Unit)					
C1783	VCKYCY1HB103KY	AA		R	0.01 50V Ceramic
C1784	RC-KZA073WJZZY	AD		R	Capacitor
C1903	VCKYCY1EF104ZY	AA		R	0.1 25V Ceramic
C1904	VCKYCY1EF104ZY	AA		R	0.1 25V Ceramic
C1910	RC-KZA073WJZZY	AD		R	Capacitor
C1912	VCKYCY1HB102KY	AA		R	1000p 50V Ceramic
C1913	VCKYCY1HB102KY	AA		R	1000p 50V Ceramic
C1916	VCKYCY1HB102KY	AA		R	1000p 50V Ceramic
C1917	VCKYCY1HB102KY	AA		R	1000p 50V Ceramic
C1918	RC-KZA073WJZZY	AD		R	Capacitor
C1919	RC-KZA073WJZZY	AD		R	Capacitor
C1921	RC-KZA073WJZZY	AD		R	Capacitor
C1923	VCKYCY1HB102KY	AA		R	1000p 50V Ceramic
C1924	VCKYCY1HB102KY	AA		R	1000p 50V Ceramic
C1927	VCKYCY1HB102KY	AA		R	1000p 50V Ceramic
C1928	VCKYCY1HB103KY	AA		R	0.01 50V Ceramic
C1929	VCCCCY1HH120JY	AA		R	12p 50V Ceramic
C1930	VCKYCY1HB102KY	AA		R	1000p 50V Ceramic
C1931	RC-KZA073WJZZY	AD		R	Capacitor
C1934	VCCCCY1HH120JY	AA		R	12p 50V Ceramic
C1935	RC-KZA073WJZZY	AD		R	Capacitor
C1936	VCKYCY1HB102KY	AA		R	1000p 50V Ceramic
C1941	VCKYCY1HB102KY	AA		R	1000p 50V Ceramic
C1943	VCKYCY1HB102KY	AA		R	1000p 50V Ceramic
C1946	VCKYCY1HB102KY	AA		R	1000p 50V Ceramic
C1947	VCKYCY1EF104ZY	AA		R	0.1 25V Ceramic
C1948	VCKYCY1HB102KY	AA		R	1000p 50V Ceramic
C1953	VCKYCY1EF104ZY	AA		R	0.1 25V Ceramic
C1955	VCKYCY1HB102KY	AA		R	1000p 50V Ceramic
C1956	VCKYCY1HB102KY	AA		R	1000p 50V Ceramic
C1959	VCKYCY1EF104ZY	AA		R	0.1 25V Ceramic
C1960	VCKYCY1HB102KY	AA		R	1000p 50V Ceramic
C1965	VCKYCY1HB102KY	AA		R	1000p 50V Ceramic
C1967	VCKYCY1HB102KY	AA		R	1000p 50V Ceramic
C1968	VCKYCY1HB102KY	AA		R	1000p 50V Ceramic
C1969	VCKYCY1HB102KY	AA		R	1000p 50V Ceramic
C1971	VCKYCY1HB102KY	AA		R	1000p 50V Ceramic
C1973	VCKYCY1HB102KY	AA		R	1000p 50V Ceramic
C1974	VCKYCY1HB102KY	AA		R	1000p 50V Ceramic
C1975	VCKYCY1HB102KY	AA		R	1000p 50V Ceramic
C2301	VCKYCY1EF104ZY	AA		R	0.1 25V Ceramic
C2302	VCKYCY1EF104ZY	AA		R	0.1 25V Ceramic
C2303	VCKYCY1EF104ZY	AA		R	0.1 25V Ceramic
C2304	VCKYCY1EF104ZY	AA		R	0.1 25V Ceramic
C2305	VCKYCY1EF104ZY	AA		R	0.1 25V Ceramic
C2306	VCEASX1CN106MY	AC		R	10 16V Electrolytic
C2307	VCKYCY1EF104ZY	AA		R	0.1 25V Ceramic
C2308	VCKYCY1HB104KY	AA		R	0.1 50V Ceramic
C2309	VCKYCY1HB104KY	AA		R	0.1 50V Ceramic
C2310	VCKYCY1HB104KY	AA		R	0.1 50V Ceramic
C2311	VCKYCY1EF104ZY	AA		R	0.1 25V Ceramic
C2312	VCCCCY1HH330JY	AA		R	33p 50V Ceramic
C2313	VCKYCY1EF104ZY	AA		R	0.1 25V Ceramic
C2314	VCKYCY1EF104ZY	AA		R	0.1 25V Ceramic
C2315	VCCCCY1HH330JY	AA		R	33p 50V Ceramic
C2316	VCKYCY1EF104ZY	AA		R	0.1 25V Ceramic
C2317	VCKYCY1EF104ZY	AA		R	0.1 25V Ceramic
C2318	VCCCCY1HH100DY	AA		R	10p 50V Ceramic
C2320	VCKYCY1EF104ZY	AA		R	0.1 25V Ceramic
C2321	RC-KZA073WJZZY	AD		R	Capacitor
C2322	VCCCCY1HH471JY	AA		R	470p 50V Ceramic
C2323	VCCCCY1HH471JY	AA		R	470p 50V Ceramic
C2328	VCKYCY1EF104ZY	AA		R	0.1 25V Ceramic
C2329	RC-KZA510WJJPZY	AB		R	Capacitor
C2330	VCCCCY1HH471JY	AA		R	470p 50V Ceramic
C2701	VCCCCY1HH470JY	AA		R	47p 50V Ceramic
C2702	VCCCCY1HH101JY	AA		R	100p 50V Ceramic
C2703	VCCCCY1HH101JY	AA		R	100p 50V Ceramic
C2704	VCCCCY1HH101JY	AA		R	100p 50V Ceramic
C2705	VCCCCY1HH101JY	AA		R	100p 50V Ceramic
C2706	VCEASX1HN105MY	AB		R	1 50V Electrolytic
C2707	VCEASX1HN105MY	AB		R	1 50V Electrolytic
C2708	VCEASX1HN105MY	AB		R	1 50V Electrolytic
C2709	VCEASX1HN105MY	AB		R	1 50V Electrolytic
C2710	VCCCCY1HH181JY	AA		R	180p 50V Ceramic
C2711	VCCCCY1HH471JY	AA		R	470p 50V Ceramic
C2712	VCKYCY1EF104ZY	AA		R	0.1 25V Ceramic
C2713	VCCCCY1HH101JY	AA		R	100p 50V Ceramic
C2714	VCEASX1CN106MY	AC		R	10 16V Electrolytic
C2715	VCKYCY1EF104ZY	AA		R	0.1 25V Ceramic
C2718	VCKYCY1CF105ZY	AA		R	1 16V Ceramic
C2719	VCKYCY1CF105ZY	AA		R	1 16V Ceramic
C2722	VCKYCY1EF104ZY	AA		R	0.1 25V Ceramic
C2723	VCKYCY1EF104ZY	AA		R	0.1 25V Ceramic
C2724	VCKYCY1EF104ZY	AA		R	0.1 25V Ceramic

LC-46/52XD1E-RU

NO.	PARTS CODE	PRICE RANK	NEW MARK	PART DELIVERY	DESCRIPTION
[3] DUNTKD915FM01 (MAIN Unit)					
C2725	VCKYCY1HB221KY	AA		R	220p 50V Ceramic
C2726	VCKYTV1EB104KY	AB		R	0.1 25V Ceramic
C2733	VCKYCY1EF104ZY	AA		R	0.1 25V Ceramic
C2734	VCKYCY1EF104ZY	AA		R	0.1 25V Ceramic
C2739	VCKYCY1EF104ZY	AA		R	0.1 25V Ceramic
C2740	VCKYTV1HB103KY	AA		R	0.01 50V Ceramic
C2741	RC-KZA073WJZZY	AD		R	Capacitor
C3001	VCKYCY1EF104ZY	AA		R	0.1 25V Ceramic
C3002	VCKYCY1HB103KY	AA		R	0.01 50V Ceramic
C3003	VCKYCY1EF104ZY	AA		R	0.1 25V Ceramic
C3004	RC-KZA073WJZZY	AD		R	Capacitor
C3005	VCKYCY1EF104ZY	AA		R	0.1 25V Ceramic
C3006	RC-KZA073WJZZY	AD		R	Capacitor
C3008	VCKYCY1HB103KY	AA		R	0.01 50V Ceramic
C3009	VCKYCY1EF104ZY	AA		R	0.1 25V Ceramic
C3010	VCKYCY1EF104ZY	AA		R	0.1 25V Ceramic
C3011	VCKYCY1EF104ZY	AA		R	0.1 25V Ceramic
C3012	VCCCCY1HH101JY	AA		R	100p 50V Ceramic
C3013	RC-KZA073WJZZY	AD		R	Capacitor
C3014	VCKYCY1HB104KY	AA		R	0.1 50V Ceramic
C3015	VCKYCY1EF104ZY	AA		R	0.1 25V Ceramic
C3016	VCKYCY1EF104ZY	AA		R	0.1 25V Ceramic
C3017	VCCCCY1HH101JY	AA		R	100p 50V Ceramic
C3018	VCKYCY1HB102KY	AA		R	1000p 50V Ceramic
C3019	RC-KZA073WJZZY	AD		R	Capacitor
C3020	VCKYCY1EF104ZY	AA		R	0.1 25V Ceramic
C3021	VCKYCY1EF104ZY	AA		R	0.1 25V Ceramic
C3022	VCCCCY1HH101JY	AA		R	100p 50V Ceramic
C3023	VCKYCY1HB102KY	AA		R	1000p 50V Ceramic
C3024	RC-KZA073WJZZY	AD		R	Capacitor
C3025	VCKYCY1EF104ZY	AA		R	0.1 25V Ceramic
C3026	VCKYCY1EF104ZY	AA		R	0.1 25V Ceramic
C3027	RC-KZA073WJZZY	AD		R	Capacitor
C3028	VCKYCY1EF104ZY	AA		R	0.1 25V Ceramic
C3029	VCKYCY1EF104ZY	AA		R	0.1 25V Ceramic
C3030	VCKYCY1EF104ZY	AA		R	0.1 25V Ceramic
C3031	VCKYCY1EF104ZY	AA		R	0.1 25V Ceramic
C3032	RC-KZA073WJZZY	AD		R	Capacitor
C3033	VCKYCY1EF104ZY	AA		R	0.1 25V Ceramic
C3034	VCCCCY1HH150JY	AA		R	15p 50V Ceramic
C3035	VCKYCY1EF104ZY	AA		R	0.1 25V Ceramic
C3036	RC-KZA073WJZZY	AD		R	Capacitor
C3037	VCKYCY1HB102KY	AA		R	1000p 50V Ceramic
C3038	VCKYCY1HB102KY	AA		R	1000p 50V Ceramic
C3039	VCCCCY1HH180JY	AA		R	18p 50V Ceramic
C3040	VCCCCY1HH101JY	AA		R	100p 50V Ceramic
C3041	RC-KZA073WJZZY	AD		R	Capacitor
C3042	VCKYCY1HB102KY	AA		R	1000p 50V Ceramic
C3043	VCKYCY1HB103KY	AA		R	0.01 50V Ceramic
C3044	VCKYCY1HB103KY	AA		R	0.01 50V Ceramic
C3045	VCKYCY1HB103KY	AA		R	0.01 50V Ceramic
C3046	VCCCCY1HH101JY	AA		R	100p 50V Ceramic
C3047	VCKYCY1HB102KY	AA		R	1000p 50V Ceramic
C3048	VCCCCY1HH101JY	AA		R	100p 50V Ceramic
C3049	VCKYCY1HB102KY	AA		R	1000p 50V Ceramic
C3050	VCCCCY1HH101JY	AA		R	100p 50V Ceramic
C3301	VCKYCY1EF104ZY	AA		R	0.1 25V Ceramic
C3302	VCKYCY1EF104ZY	AA		R	0.1 25V Ceramic
C3303	VCKYCY1EF104ZY	AA		R	0.1 25V Ceramic
C3304	VCKYCY1EF104ZY	AA		R	0.1 25V Ceramic
C3305	VCKYCY1EF104ZY	AA		R	0.1 25V Ceramic
C3306	VCKYCY1EF104ZY	AA		R	0.1 25V Ceramic
C3307	VCKYCY1EF104ZY	AA		R	0.1 25V Ceramic
C3308	VCKYCY1EF104ZY	AA		R	0.1 25V Ceramic
C3309	VCKYCY1EF104ZY	AA		R	0.1 25V Ceramic
C3310	VCKYCY1EF104ZY	AA		R	0.1 25V Ceramic
C3311	VCKYCY1EF104ZY	AA		R	0.1 25V Ceramic
C3312	VCKYCY1EF104ZY	AA		R	0.1 25V Ceramic
C3313	VCKYCY1EF104ZY	AA		R	0.1 25V Ceramic
C3314	VCKYCY1EF104ZY	AA		R	0.1 25V Ceramic
C3315	VCCCCY1HH220JY	AA		R	22p 50V Ceramic
C3316	VCKYCY1EF104ZY	AA		R	0.1 25V Ceramic
C3317	VCKYCY1EF104ZY	AA		R	0.1 25V Ceramic
C3318	VCCCCY1HH220JY	AA		R	22p 50V Ceramic
C3319	VCKYCY1EF104ZY	AA		R	0.1 25V Ceramic
C3320	VCKYCY1EF104ZY	AA		R	0.1 25V Ceramic
C3321	VCKYCY1EF104ZY	AA		R	0.1 25V Ceramic
C3322	VCKYCY1EF104ZY	AA		R	0.1 25V Ceramic
C3323	VCKYCY1EF104ZY	AA		R	0.1 25V Ceramic
C3324	VCKYCY1EF104ZY	AA		R	0.1 25V Ceramic
C3325	VCKYCY1EF104ZY	AA		R	0.1 25V Ceramic
C3326	VCKYCY1EF104ZY	AA		R	0.1 25V Ceramic
C3327	VCKYCY1EF104ZY	AA		R	0.1 25V Ceramic
C3328	VCKYCY1EF104ZY	AA		R	0.1 25V Ceramic
C3329	VCKYCY1EF104ZY	AA		R	0.1 25V Ceramic

NO.	PARTS CODE	PRICE RANK	NEW MARK	PART DELIVERY	DESCRIPTION
[3] DUNTKD915FM01 (MAIN Unit)					
C3330	VCKYCY1EF104ZY	AA		R	0.1 25V Ceramic
C3331	RC-KZA073WJZZY	AD		R	Capacitor
C3332	RC-KZA073WJZZY	AD		R	Capacitor
C3333	RC-KZA073WJZZY	AD		R	Capacitor
C3334	RC-KZA073WJZZY	AD		R	Capacitor
C3335	VCEASY1CN476MY	AC		R	47 16V Electrolytic
C3336	VCEASY1CN476MY	AC		R	47 16V Electrolytic
C3337	VCKYCY1HB102KY	AA		R	1000p 50V Ceramic
C3338	VCKYCY1HB102KY	AA		R	1000p 50V Ceramic
C3339	VCCCCY1HH101JY	AA		R	100p 50V Ceramic
C3340	VCKYCY1HB102KY	AA		R	1000p 50V Ceramic
C3341	VCCCCY1HH101JY	AA		R	100p 50V Ceramic
C3342	VCKYCY1HB102KY	AA		R	1000p 50V Ceramic
C3343	VCCCCY1HH101JY	AA		R	100p 50V Ceramic
C3501	VCKYCY1CF104ZY	AA		R	0.1 16V Ceramic
C3502	VCKYCY1CF104ZY	AA		R	0.1 16V Ceramic
C3503	VCKYCY1CF104ZY	AA		R	0.1 16V Ceramic
C3504	VCKYCY1CF104ZY	AA		R	0.1 16V Ceramic
C3505	VCKYCY1CF104ZY	AA		R	0.1 16V Ceramic
C3506	VCKYCY1CF104ZY	AA		R	0.1 16V Ceramic
C3507	VCKYCY1CF104ZY	AA		R	0.1 16V Ceramic
C3508	VCKYCY1CF104ZY	AA		R	0.1 16V Ceramic
C3509	VCKYCY1CF104ZY	AA		R	0.1 16V Ceramic
C3510	VCKYCY1CF104ZY	AA		R	0.1 16V Ceramic
C3511	VCKYCY1CF104ZY	AA		R	0.1 16V Ceramic
C3512	VCKYCY1CF104ZY	AA		R	0.1 16V Ceramic
C3513	VCKYCY1CF104ZY	AA		R	0.1 16V Ceramic
C3514	VCKYCY1CF104ZY	AA		R	0.1 16V Ceramic
C3515	VCKYCY1CF104ZY	AA		R	0.1 16V Ceramic
C3516	VCKYCY1CF104ZY	AA		R	0.1 16V Ceramic
C3517	VCKYCY1CF104ZY	AA		R	0.1 16V Ceramic
C3518	VCKYCY1CF104ZY	AA		R	0.1 16V Ceramic
C3519	VCKYCY1CF104ZY	AA		R	0.1 16V Ceramic
C3520	VCKYCY1CF104ZY	AA		R	0.1 16V Ceramic
C3521	RC-KZA073WJZZY	AD		R	Capacitor
C3522	VCKYCY1HB102KY	AA		R	1000p 50V Ceramic
C3525	VCCCCY1HH101JY	AA		R	100p 50V Ceramic
C3526	VCCCCY1HH101JY	AA		R	100p 50V Ceramic
C3527	VCKYCY1HB102KY	AA		R	1000p 50V Ceramic
C3528	VCCCCY1HH101JY	AA		R	100p 50V Ceramic
C3529	RC-KZ0124TAZZY	AC		R	Capacitor
C3530	RC-KZ0124TAZZY	AC		R	Capacitor
C3531	VCCCCY1HH101JY	AA		R	100p 50V Ceramic
C3532	VCEASX0JN227MY	AC		R	220 6.3V Electrolytic
C3533	VCKYCY1CF104ZY	AA		R	0.1 16V Ceramic
C3534	VCKYCY1CF104ZY	AA		R	0.1 16V Ceramic
C3535	VCKYCY1CF104ZY	AA		R	0.1 16V Ceramic
C3536	VCKYCY1CF104ZY	AA		R	0.1 16V Ceramic
C3537	VCCCCY1HH101JY	AB		R	100p 50V Ceramic
C3538	VCKYCY1CF104ZY	AA		R	0.1 16V Ceramic
C3539	VCKYCY1CF104ZY	AA		R	0.1 16V Ceramic
C3540	VCKYCY1CF104ZY	AA		R	0.1 16V Ceramic
C3541	VCKYCY1CF104ZY	AA		R	0.1 16V Ceramic
C3542	VCKYCY1CF104ZY	AA		R	0.1 16V Ceramic
C3543	VCKYCY1CF104ZY	AA		R	0.1 16V Ceramic
C3544	VCKYCY1CF104ZY	AA		R	0.1 16V Ceramic
C3545	VCKYCY1CF104ZY	AA		R	0.1 16V Ceramic
C3546	VCKYCY1CF104ZY	AA		R	0.1 16V Ceramic
C3547	VCKYCY1CF104ZY	AA		R	0.1 16V Ceramic
C3548	VCKYCY1CF104ZY	AA		R	0.1 16V Ceramic
C3549	VCKYCY1CF104ZY	AA		R	0.1 16V Ceramic
C3550	VCKYCY1CF104ZY	AA		R	0.1 16V Ceramic
C3551	RC-KZ0124TAZZY	AC		R	Capacitor
C3552	VCKYCY1CF104ZY	AA		R	0.1 16V Ceramic
C3553	VCKYCY1CF104ZY	AA		R	0.1 16V Ceramic
C3554	VCKYCY1CF104ZY	AA		R	0.1 16V Ceramic
C3555	VCKYCY1CF104ZY	AA		R	0.1 16V Ceramic
C3556	VCKYCY1CF104ZY	AA		R	0.1 16V Ceramic
C3557	VCKYCY1CF104ZY	AA		R	0.1 16V Ceramic
C3558	VCKYCY1CF104ZY	AA		R	0.1 16V Ceramic
C3559	VCKYCY1CF104ZY	AA		R	0.1 16V Ceramic
C3560	RC-KZA067WJZZY	AB		R	Capacitor
C3563	VCKYCY1HB102KY	AA		R	1000p 50V Ceramic
C3564	VCKYCY1HB102KY	AB		R	1000p 50V Ceramic
C3567	RC-KZ0124TAZZY	AC		R	Capacitor
C3568	VCKYTV1CB105KY	AC		R	1 16V Ceramic
C3569	RC-KZ0124TAZZY	AC		R	Capacitor
C3701	VCKYCY1EF104ZY	AA		R	0.1 25V Ceramic
C3702	VCEASY1CN107MY	AC		R	100 16V Electrolytic
C3703	VCKYCY1HB103KY	AA		R	0.01 50V Ceramic
C3704	VCEASX1CN106MY	AC		R	10 16V Electrolytic
C3705	VCEASX1CN106MY	AC		R	10 16V Electrolytic
C3706	VCEASY1CN107MY	AC		R	100 16V Electrolytic
C3707	VCKYCY1EF104ZY	AA		R	0.1 25V Ceramic
C3708	VCEASX1HN335MY	AB		R	3.3 50V Electrolytic

NO.	PARTS CODE	PRICE RANK	NEW MARK	PART DELIVERY	DESCRIPTION
[3] DUNTKD915FM01 (MAIN Unit)					
C3709	VCKYCY1EF104ZY	AA		R	0.1 25V Ceramic
C3710	VCKYCY1EF104ZY	AA		R	0.1 25V Ceramic
C3711	VCEASX1CN106MY	AC		R	10 16V Electrolytic
C3712	VCCCCY1HH471JY	AA		R	470p 50V Ceramic
C3713	VCEASY1CN107MY	AC		R	100 16V Electrolytic
C3714	VCCCCY1HH560JY	AB		R	56p 50V Ceramic
C3715	VCCCCY1HH560JY	AB		R	56p 50V Ceramic
C3716	VCCCCY1HH560JY	AB		R	56p 50V Ceramic
C3717	VCCCCY1HH5R0CY	AA		R	50p 50V Ceramic
C3718	VCCCCY1HH6R0DY	AA		R	60p 50V Ceramic
C3719	VCCCCY1HH331JY	AA		R	330p 50V Ceramic
C3720	VCCCCY1HH331JY	AA		R	330p 50V Ceramic
C3721	VCCCCY1HH331JY	AA		R	330p 50V Ceramic
C3722	VCCCCY1HH331JY	AA		R	330p 50V Ceramic
C3723	VCCCCY1HH331JY	AA		R	330p 50V Ceramic
C3724	VCCCCY1HH331JY	AA		R	330p 50V Ceramic
C3725	VCCCCY1HH331JY	AA		R	330p 50V Ceramic
C3726	VCCCCY1HH331JY	AA		R	330p 50V Ceramic
C3727	VCCCCY1HH101JY	AA		R	100p 50V Ceramic
C3728	VCCCCY1HH101JY	AA		R	100p 50V Ceramic
C3729	VCCCCY1HH101JY	AA		R	100p 50V Ceramic
C3730	VCCCCY1HH101JY	AA		R	100p 50V Ceramic
C3731	VCCCCY1HH101JY	AA		R	100p 50V Ceramic
C3732	VCCCCY1HH101JY	AA		R	100p 50V Ceramic
C3733	VCCCCY1HH101JY	AA		R	100p 50V Ceramic
C3734	VCCCCY1HH101JY	AA		R	100p 50V Ceramic
C3735	VCKYCY1EF104ZY	AA		R	0.1 25V Ceramic
C3736	VCKYCY1EF104ZY	AA		R	0.1 25V Ceramic
C3737	VCKYCY1EF104ZY	AA		R	0.1 25V Ceramic
C3738	RC-KZA073WJZZY	AD		R	Capacitor
C3739	RC-KZA073WJZZY	AD		R	Capacitor
C3740	VCKYCY1HF224ZY	AA		R	0.22 50V Ceramic
C3741	RC-KZA073WJZZY	AD		R	Capacitor
C3742	RC-KZA073WJZZY	AD		R	Capacitor
C3743	VCCCCY1HH101JY	AA		R	100p 50V Ceramic
C3744	VCCCCY1HH101JY	AA		R	100p 50V Ceramic
D1702	RH-EX0487CEZZY	AC		R	HZM2.0NBTL-E
D1703	VHD1SS352//--1Y			R	1SS352(TPH3,F)
D1704	VHDTCCMS01+-1Y			R	CMSO1(TE12L,Q)
D1705	VHD1SS352//--1Y			R	1SS352(TPH3,F)
D1706	VHD1SS352//--1Y			R	1SS352(TPH3,F)
D1707	RH-EX0487CEZZY	AC		R	HZM2.0NBTL-E
D1708	VHDTCCMS01+-1Y			R	CMSO1(TE12L,Q)
D1709	VHDTCCMS01+-1Y			R	CMSO1(TE12L,Q)
D1901	VHDDAN202K/-1Y	AB		R	DAN202KT146
D1902	VHDDAN202K/-1Y	AB		R	DAN202KT146
D1903	VHD1SS352//--1Y			R	1SS352(TPH3,F)
D1904	VHD1SS352//--1Y			R	1SS352(TPH3,F)
D1905	VHD1SS352//--1Y			R	1SS352(TPH3,F)
D1906	VHD1SS352//--1Y			R	1SS352(TPH3,F)
D1913	VHDRB520S30-1Y			R	RB520S-30TE61
D2301	RH-EX1271CEZZY	AB		R	HZU12B2TRF
D2302	RH-EX1271CEZZY	AB		R	HZU12B2TRF
D2303	RH-EX1271CEZZY	AB		R	HZU12B2TRF
D2304	RH-EX1271CEZZY	AB		R	HZU12B2TRF
D2305	RH-EX1247CEZZY	AB		R	HZU5.6B2TRF
D2306	RH-EX1247CEZZY	AB		R	HZU5.6B2TRF
D2307	RH-EX1247CEZZY	AB		R	HZU5.6B2TRF
D2308	RH-EX1247CEZZY	AB		R	HZU5.6B2TRF
D2309	VHDDAN202K/-1Y	AB		R	DAN202KT146
D2310	VHD1SS226//--1Y	AC		R	1SS226(T5L,F,T)
D2311	VHD1SS226//--1Y	AC		R	1SS226(T5L,F,T)
D2312	VHD1SS226//--1Y	AC		R	1SS226(T5L,F,T)
D2313	RH-EX1247CEZZY	AB		R	HZU5.6B2TRF
D2314	RH-EX1271CEZZY	AB		R	HZU12B2TRF
D2315	RH-EX1271CEZZY	AB		R	HZU12B2TRF
D2317	RH-EX1247CEZZY	AB		R	HZU5.6B2TRF
D2318	RH-EX1247CEZZY	AB		R	HZU5.6B2TRF
D2319	RH-EX1247CEZZY	AB		R	HZU5.6B2TRF
D2707	VHD1SS390++-1Y	AB		R	1SS390TE61
D2708	VHD1SS390++-1Y	AB		R	1SS390TE61
FB1701	RBLN-0250TAZZY	AC		R	Balun
FB1702	RBLN-0250TAZZY	AC		R	Balun
FB1703	RBLN-0061TAZZY	AD		R	Balun
FB1704	RBLN-0061TAZZY	AD		R	Balun
FB1705	RBLN-0250TAZZY	AC		R	Balun
FB1706	RBLN-0250TAZZY	AC		R	Balun
FB1707	RBLN-0250TAZZY	AC		R	Balun
FB1901	RBLN-0060TAZZY	AB		R	Balun
FB1902	RBLN-0060TAZZY	AB		R	Balun
FB1903	RBLN-0060TAZZY	AB		R	Balun
FB1904	RBLN-0060TAZZY	AB		R	Balun
FB1905	RBLN-0060TAZZY	AB		R	Balun
FB1906	RBLN-0060TAZZY	AB		R	Balun
FB1907	RBLN-0210TAZZY	AB		R	Balun

NO.	PARTS CODE	PRICE RANK	NEW MARK	PART DELIVERY	DESCRIPTION
[3] DUNTKD915FM01 (MAIN Unit)					
FB1908	RBLN-0060TAZZY	AB		R	Balun
FB1909	RBLN-0210TAZZY	AB		R	Balun
FB2301	RBLN-0061TAZZY	AD		R	Balun
FB2302	RBLN-0061TAZZY	AD		R	Balun
FB2303	RBLN-0210TAZZY	AB		R	Balun
FB2305	RBLN-0061TAZZY	AD		R	Balun
FB2306	RBLN-0061TAZZY	AD		R	Balun
FB2307	RBLN-0061TAZZY	AD		R	Balun
FB2308	RBLN-0061TAZZY	AD		R	Balun
FB2309	RBLN-0061TAZZY	AD		R	Balun
FB2310	RBLN-0210TAZZY	AB		R	Balun
FB2701	RBLN-0254TAZZY	AB		R	Balun
FB2702	RBLN-0254TAZZY	AB		R	Balun
FB2703	RBLN-0254TAZZY	AB		R	Balun
FB2705	RBLN-0061TAZZY	AD		R	Balun
FB2706	RBLN-0061TAZZY	AD		R	Balun
FB2707	RBLN-0061TAZZY	AD		R	Balun
FB2708	RBLN-0061TAZZY	AD		R	Balun
FB2709	RBLN-0061TAZZY	AD		R	Balun
FB2710	RBLN-0061TAZZY	AD		R	Balun
FB2711	RBLN-0061TAZZY	AD		R	Balun
FB2713	RBLN-0254TAZZY	AB		R	Balun
FB2714	RBLN-0254TAZZY	AB		R	Balun
FB2715	RBLN-0210TAZZY	AB		R	Balun
FB2716	RBLN-0210TAZZY	AB		R	Balun
FB3001	RBLN-0254TAZZY	AB		R	Balun
FB3002	RBLN-0254TAZZY	AB		R	Balun
FB3004	RBLN-0254TAZZY	AB		R	Balun
FB3005	RBLN-0254TAZZY	AB		R	Balun
FB3006	RBLN-0254TAZZY	AB		R	Balun
FB3007	RBLN-0254TAZZY	AB		R	Balun
FB3008	RBLN-0254TAZZY	AB		R	Balun
FB3009	RBLN-0254TAZZY	AB		R	Balun
FB3010	RBLN-0254TAZZY	AB		R	Balun
FB3014	RBLN-0254TAZZY	AB		R	Balun
FB3301	RBLN-0254TAZZY	AB		R	Balun
FB3302	RBLN-0254TAZZY	AB		R	Balun
FB3303	RBLN-0254TAZZY	AB		R	Balun
FB3304	RBLN-0254TAZZY	AB		R	Balun
FB3305	RBLN-0254TAZZY	AB		R	Balun
FB3306	RBLN-0254TAZZY	AB		R	Balun
FB3501	RBLN-0250TAZZY	AC		R	Balun
FB3502	RBLN-0250TAZZY	AC		R	Balun
FB3503	RBLN-0250TAZZY	AC		R	Balun
FB3701	RBLN-0254TAZZY	AB		R	Balun
FB3702	RBLN-0254TAZZY	AB		R	Balun
FB3703	RBLN-0254TAZZY	AB		R	Balun
FB3705	RBLN-0254TAZZY	AB		R	Balun
FL2301	RF i LN0003TAZZY	AD		R	Filter
FL2302	RF i LN0003TAZZY	AD		R	Filter
FL2303	RF i LN0003TAZZY	AD		R	Filter
FL2304	RC i LFA071WJZZY	AD		R	Coil
FL2305	RC i LFA071WJZZY	AD		R	Coil
FL2306	RC i LFA071WJZZY	AD		R	COIL
FL2307	RC i LFA071WJZZY	AD		R	COIL
FL2308	RC i LFA071WJZZY	AD		R	COIL
FL2309	RC i LFA071WJZZY	AD		R	COIL
FL2310	RC i LFA071WJZZY	AD		R	Coil
FL2311	RC i LFA071WJZZY	AD		R	Coil
FL2312	RC i LFA071WJZZY	AD		R	Coil
FL2313	RC i LFA071WJZZY	AD		R	Coil
FL2314	RC i LFA071WJZZY	AD		R	Coil
FL2315	RC i LFA071WJZZY	AD		R	Coil
IC1701	VH i BU4239G+-1Y	AE		R	BU4239G-TR
IC1702	VH i PQ20WZ11-1Y	AF		R	PQ20WZ1UJ00H
IC1703	VH i PQ20WZ11-1Y	AF		R	PQ20WZ1UJ00H
IC1705	VH i PQ1R50//1Y	AF		R	PQ1R50J0000H
IC1706	VH i MP1583+-1Y	AH		R	MP1583DN-LF-Z
IC1707	VH i PQ20WZ11-1Y	AF		R	PQ20WZ1UJ00H
IC1708	VH i MP1410ES-1Y	AP		R	MP1410ES-LF-Z
IC1709	VSSM6J51TU-1Y	AF		R	SSM6J51TU(TE85L,F)
IC1710	RH- i XB946WJZZQ		N	R	EPM240T100C5N
IC1712	VH i MP1410ES-1Y	AP		R	MP1410ES-LF-Z
IC1901	VH i 24LC2B i N-1Y	AF		R	24LC02BT-i/SN
IC1902	VH i 24LC2B i N-1Y	AF		R	24LC02BT-i/SN
IC1905	VH i Si i 9023+-1Q		N	R	Si9023CTU
IC2301	VH i i CL3225E-1Y	AN		R	iCL3225ECAZ-T
IC2303	VH i BR24C21F-1Y	AG		R	BR24C21F-E2
IC2304	VH i TL712CPW-1Y	AK		R	TL712CPWR
IC2305	VH i TL712CPW-1Y	AK		R	TL712CPWR
IC2306	VH i TC7W53U/-1Y	AF		R	TC7W53FU(TE12L,F)
IC2307	VH i TC7W00U/-1Y	AE		R	TC7W00FU(TE12L,F)
IC2701	VH i LCX125FT-1Y	AD		R	TC74LCX125FT(EL,K)
IC2704	VH i TC4052BT-1Y	AF		R	TC4052BFT(EL,N,M)
IC3001	RH- i XA992WJZZY	AM		R	M24256-BVMN6TP

NO.	PARTS CODE	PRICE RANK	NEW MARK	PART DELIVERY	DESCRIPTION
[3] DUNTKD915FM01 (MAIN Unit)					
IC3002	RH-iXB755WJZZQ			R	VGC5969B-AD-A3
IC3003	VH iT7WB125A-1Y	AE		R	TC7WBD125AFK(T5L,F)
IC3004	VH iBU4228G+-1Y	AD		R	BU4228G-TR
IC3005	VH iBU4214G+-1Y			R	BU4214G-TR
IC3301	RH-iXB064WJN1Q	BR		R	FRC9429A-XX-B2
IC3501	RH-iXB765WJQZQ	AW		R	K4H561638H-UCB3
IC3502	RH-iXB765WJQZQ	AW		R	K4H561638H-UCB3
IC3503	RH-iXB754WJZZQ			R	M29DW128F70NF6E
IC3504	RH-iXB753WJZZY			R	SN74LVCH16373ADGGR
IC3506	VH iBD3533F+-1Y	AG		R	BD3533F-E2
IC3701	RH-iXB752WJZZQ			R	MSP4410K-QA-D6
IC3702	VH iAK4363VF-1Y	AQ		R	AK4363VF
J2701	QJAKEA073WJZZ	AD		R	Jack
J2702	QJAKEA073WJZZ	AD		R	Jack
L1701	RC iLPA212WJZZY			R	Coil
L1702	RC iLPA213WJZZY	AG		R	Coil
L1703	RC iLPA213WJZZY	AG		R	Coil
L1901	RC iLFA134WJZZY	AF		R	Coil
L1902	RC iLFA134WJZZY	AF		R	Coil
L1903	RC iLFA134WJZZY	AF		R	Coil
L1904	RC iLFA134WJZZY	AF		R	Coil
L1905	RC iLFA134WJZZY	AF		R	Coil
L1906	RC iLFA134WJZZY	AF		R	Coil
L1907	RC iLFA134WJZZY	AF		R	Coil
L1908	RC iLFA134WJZZY	AF		R	Coil
L2703	VPCUN1R5MR12NY	AC		R	Peaking 1.5uH
LUG1701	QLUGHA006WJZZY	AC		R	Lug
LUG1702	QLUGHA006WJZZY	AC		R	Lug
LUG1703	QLUGHA006WJZZY	AC		R	Lug
LUG1704	QLUGHA006WJZZY	AC		R	Lug
LUG1705	QLUGZA002WJZZY	AC		R	Lug
LUG1706	QLUGZA002WJZZY	AC		R	Lug
LUG1707	QLUGZA002WJZZY	AC		R	Lug
LUG1708	QLUGZA002WJZZY	AC		R	Lug
LUG1709	QLUGZA002WJZZY	AC		R	Lug
LUG1710	QLUGZA002WJZZY	AC		R	Lug
P1701	QPLGNA343WJZZY	AD		R	Plug
P1702	QPLGN1075TAZZY	AD		R	Plug
P2302	QPLGNA338WJZZY	AD		R	Plug
P2303	QPLGNA347WJZZY	AD		R	Plug
P2304	QSOCNA472WJZZY	AD		R	Socket
P2702	QCNCMA202WJZZY	AK		R	Connector
P3001	QPLGNA339WJZZY	AD		R	Plug
Q1701	VS2SC3928AR-1Y	AB		R	2SC3928A-T112-1R
Q1702	VS2SA1530AR-1Y	AB		R	2SA1530A-T112-1R
Q1703	VS2SC3928AR-1Y	AB		R	2SC3928A-T112-1R
Q1704	VS2SA1530AR-1Y	AB		R	2SA1530A-T112-1R
Q1706	VSCPH6318+-1Y			R	CPH6318-TL-E
Q1901	VS2SK536///-1Y	AE		R	2SK536-TB-E
Q1902	VS2SK536///-1Y	AE		R	2SK536-TB-E
Q1903	VS2SK536///-1Y	AE		R	2SK536-TB-E
Q1904	VS2SK536///-1Y	AE		R	2SK536-TB-E
Q1905	VSDTC144EE/-1Y	AA		R	DTC144EETL
Q1906	VSDTC144EE/-1Y	AA		R	DTC144EETL
Q1907	VSDTC144EE/-1Y	AA		R	DTC144EETL
Q1908	VSDTC144EE/-1Y	AA		R	DTC144EETL
Q1909	VSDTC144EE/-1Y	AA		R	DTC144EETL
Q1910	VSDTC144EE/-1Y	AA		R	DTC144EETL
Q2302	VSDTC114EE/-1Y	AB		R	DTC114EETL
Q2303	VSDTC114EE/-1Y	AB		R	DTC114EETL
Q2304	VSDTC144EE/-1Y	AA		R	DTC144EETL
Q2305	VS2SC3928AR-1Y	AB		R	2SC3928A-T112-1R
Q2306	VS2SA1530AR-1Y	AB		R	2SA1530A-T112-1R
Q2307	VS2SC3928AR-1Y	AB		R	2SC3928A-T112-1R
Q2312	VS2SA1530AR-1Y	AB		R	2SA1530A-T112-1R
Q2313	VS2SA1530AR-1Y	AB		R	2SA1530A-T112-1R
Q2314	VS2SA1530AR-1Y	AB		R	2SA1530A-T112-1R
Q2315	VS2SA1530AR-1Y	AB		R	2SA1530A-T112-1R
Q2701	VS2SC3928AR-1Y	AB		R	2SC3928A-T112-1R
Q2702	VS2SC3928AR-1Y	AB		R	2SC3928A-T112-1R
Q2703	VS2SC3928AR-1Y	AB		R	2SC3928A-T112-1R
Q2704	VS2SC3928AR-1Y	AB		R	2SC3928A-T112-1R
Q2705	VS2SC3928AR-1Y	AB		R	2SC3928A-T112-1R
Q2706	VS2SC3928AR-1Y	AB		R	2SC3928A-T112-1R
Q2707	VSDTC144EE/-1Y	AA		R	DTC144EETL
Q2708	VSDTC144EE/-1Y	AA		R	DTC144EETL
Q2709	VSSSM3K15FS-1Y			R	SSM3K15FS(TE85L,F)
Q2710	VSSSM3K15FS-1Y			R	SSM3K15FS(TE85L,F)
Q2711	VS2SC3928AR-1Y	AB		R	2SC3928A-T112-1R
Q2715	VSDTC144EE/-1Y	AA		R	DTC144EETL
Q2717	VSDTC144EE/-1Y	AA		R	DTC144EETL
Q3001	VSDTC144EE/-1Y	AA		R	DTC144EETL
Q3002	VSSSM3K15FS-1Y			R	SSM3K15FS(TE85L,F)
Q3003	VSSSM3K15FS-1Y			R	SSM3K15FS(TE85L,F)
Q3004	VSSSM3K15FS-1Y			R	SSM3K15FS(TE85L,F)

NO.	PARTS CODE	PRICE RANK	NEW MARK	PART DELIVERY	DESCRIPTION
[3] DUNTKD915FM01 (MAIN Unit)					
Q3005	VSSM3K15FS-1Y			R	SSM3K15FS(TE85L,F)
Q3501	VSDTC144EE/-1Y	AA		R	DTC144EETL
Q3702	VSDTC144EE/-1Y	AA		R	DTC144EETL
Q3703	VSDTC144EE/-1Y	AA		R	DTC144EETL
R1700	VRS-CY1JF101JY	AA		R	100 1/16W Metal Oxide
R1701	VRS-CY1JF562JY	AA		R	5.6k 1/16W Metal Oxide
R1702	VRS-CY1JF103JY	AA		R	10k 1/16W Metal Oxide
R1703	VRS-TW2ED000JY	AB		R	0 1/4W Metal Oxide
R1704	VRS-CY1JF000JY	AA		R	0 1/16W Metal Oxide
R1705	VRS-CY1JF000JY	AA		R	0 1/16W Metal Oxide
R1706	VRS-CZ1JF333JY	AA		R	33k 1/16W Metal Oxide
R1707	VRS-CY1JF000JY	AA		R	0 1/16W Metal Oxide
R1709	VRS-CY1JF103JY	AA		R	10k 1/16W Metal Oxide
R1711	VRS-CY1JF101JY	AA		R	100 1/16W Metal Oxide
R1712	VRS-CY1JF103JY	AA		R	10k 1/16W Metal Oxide
R1714	VRS-CY1JF000JY	AA		R	0 1/16W Metal Oxide
R1715	VRS-CY1JF470JY	AA		R	47 1/16W Metal Oxide
R1716	VRS-CY1JF101JY	AA		R	100 1/16W Metal Oxide
R1717	VRS-CY1JF470JY	AA		R	47 1/16W Metal Oxide
R1718	VRS-CY1JF470JY	AA		R	47 1/16W Metal Oxide
R1719	VRS-CY1JF622FY	AA		R	6.2k 1/16W Metal Oxide
R1720	VRS-CY1JF103JY	AA		R	10k 1/16W Metal Oxide
R1721	VRS-CY1JF203FY	AA		R	20k 1/16W Metal Oxide
R1722	VRS-CY1JF101JY	AA		R	100 1/16W Metal Oxide
R1723	VRS-CY1JF103FY	AA		R	10k 1/16W Metal Oxide
R1725	VRS-CY1JF103JY	AA		R	10k 1/16W Metal Oxide
R1726	VRS-CY1JF511FY	AA		R	510 1/16W Metal Oxide
R1727	VRS-CY1JF101JY	AA		R	100 1/16W Metal Oxide
R1728	VRS-CY1JF332JY	AA		R	3.3k 1/16W Metal Oxide
R1729	VRS-CY1JF202FY	AA		R	2.0k 1/16W Metal Oxide
R1730	VRS-CY1JF470JY	AA		R	47 1/16W Metal Oxide
R1731	VRS-CY1JF102JY	AA		R	1k 1/16W Metal Oxide
R1732	VRS-CY1JF202FY	AA		R	2.0k 1/16W Metal Oxide
R1733	VRS-CY1JF104JY	AA		R	100k 1/16W Metal Oxide
R1734	VRS-CY1JF222FY	AA		R	2.2k 1/16W Metal Oxide
R1735	VRS-CY1JF202FY	AA		R	2.0k 1/16W Metal Oxide
R1736	VRS-CY1JF102JY	AA		R	1k 1/16W Metal Oxide
R1737	VRS-CY1JF272JY	AA		R	2.7k 1/16W Metal Oxide
R1738	VRS-CY1JF104JY	AA		R	100k 1/16W Metal Oxide
R1739	VRS-TW2HF1R0JY	AA		R	1 1/2W Metal Oxide
R1740	VRS-TW2HF1R0JY	AA		R	1 1/2W Metal Oxide
R1741	VRS-TW2HF1R0JY	AA		R	1 1/2W Metal Oxide
R1742	VRS-TW2HF1R0JY	AA		R	1 1/2W Metal Oxide
R1743	VRS-CY1JF104JY	AA		R	100k 1/16W Metal Oxide
R1744	VRS-CY1JF203FY	AA		R	20k 1/16W Metal Oxide
R1745	VRS-CY1JF132JY	AG		R	1.3k 1/16W Metal Oxide
R1746	VRS-CY1JF202JY	AA		R	2.0k 1/16W Metal Oxide
R1747	VRS-CY1JF511FY	AA		R	510 1/16W Metal Oxide
R1748	VRS-CY1JF202FY	AA		R	2.0k 1/16W Metal Oxide
R1749	VRS-CY1JF104JY	AA		R	100k 1/16W Metal Oxide
R1750	VRS-CY1JF470JY	AA		R	47 1/16W Metal Oxide
R1751	VRS-CY1JF104JY	AA		R	100k 1/16W Metal Oxide
R1753	VRS-CY1JF103FY	AA		R	10k 1/16W Metal Oxide
R1754	VRS-CY1JF622FY	AA		R	6.2k 1/16W Metal Oxide
R1755	VRS-CY1JF562JY	AA		R	5.6k 1/16W Metal Oxide
R1756	VRS-CY1JF103JY	AA		R	10k 1/16W Metal Oxide
R1757	VRS-TW2HF1R0JY	AA		R	1 1/2W Metal Oxide
R1758	VRS-TW2HF1R0JY	AA		R	1 1/2W Metal Oxide
R1759	VRS-TW2HF1R0JY	AA		R	1 1/2W Metal Oxide
R1760	VRS-TW2HF1R0JY	AA		R	1 1/2W Metal Oxide
R1761	VRS-CY1JF101JY	AA		R	100 1/16W Metal Oxide
R1762	VRS-CZ1JF220JY	AA		R	22 1/16W Metal Oxide
R1763	VRS-CY1JF101JY	AA		R	100 1/16W Metal Oxide
R1764	VRS-CY1JF101JY	AA		R	100 1/16W Metal Oxide
R1767	VRS-CY1JF823FY	AA		R	82k 1/16W Metal Oxide
R1768	VRS-CY1JF103FY	AA		R	10k 1/16W Metal Oxide
R1769	VRS-CY1JF104JY	AA		R	100k 1/16W Metal Oxide
R1770	VRS-CY1JF752JY	AA		R	7.5k 1/16W Metal Oxide
R1771	VRS-TW2HF1R0JY	AA		R	1 1/2W Metal Oxide
R1772	VRS-TW2HF1R0JY	AA		R	1 1/2W Metal Oxide
R1773	VRS-CY1JF104JY	AA		R	100k 1/16W Metal Oxide
R1774	VRS-CY1JF103JY	AA		R	10k 1/16W Metal Oxide
R1775	VRS-CY1JF104JY	AA		R	100k 1/16W Metal Oxide
R1776	VRS-CZ1JF220JY	AA		R	22 1/16W Metal Oxide
R1777	VRS-CZ1JF220JY	AA		R	22 1/16W Metal Oxide
R1779	VRS-CY1JF123FY	AA		R	12k 1/16W Metal Oxide
R1780	VRS-CY1JF103JY	AA		R	10k 1/16W Metal Oxide
R1781	VRS-CY1JF101JY	AA		R	100 1/16W Metal Oxide
R1782	VRS-CY1JF101JY	AA		R	100 1/16W Metal Oxide
R1783	VRS-CY1JF101JY	AA		R	100 1/16W Metal Oxide
R1784	VRS-CY1JF101JY	AA		R	100 1/16W Metal Oxide
R1785	VRS-CY1JF101JY	AA		R	100 1/16W Metal Oxide
R1786	VRS-CY1JF563JY	AA		R	56k 1/16W Metal Oxide
R1787	VRS-CY1JF101JY	AA		R	100 1/16W Metal Oxide
R1788	VRS-CY1JF101JY	AA		R	100 1/16W Metal Oxide

NO.	PARTS CODE	PRICE RANK	NEW MARK	PART DELIVERY	DESCRIPTION
[3] DUNTKD915FM01 (MAIN Unit)					
R1789	VRS-CY1 JF101JY	AA		R	100 1/16W Metal Oxide
R1790	VRS-CY1 JF101JY	AA		R	100 1/16W Metal Oxide
R1791	VRS-CY1 JF101JY	AA		R	100 1/16W Metal Oxide
R1792	VRS-CY1 JF101JY	AA		R	100 1/16W Metal Oxide
R1793	VRS-CY1 JF101JY	AA		R	100 1/16W Metal Oxide
R1794	VRS-CY1 JF101JY	AA		R	100 1/16W Metal Oxide
R1795	VRS-CY1 JF101JY	AA		R	100 1/16W Metal Oxide
R1796	VRS-CY1 JF101JY	AA		R	100 1/16W Metal Oxide
R1797	VRS-CY1 JF101JY	AA		R	100 1/16W Metal Oxide
R1798	VRS-CY1 JF101JY	AA		R	100 1/16W Metal Oxide
R1800	VRS-CZ1 JF220JY	AA		R	22 1/16W Metal Oxide
R1804	VRS-CY1 JF104JY	AA		R	100k 1/16W Metal Oxide
R1805	VRS-CY1 JF101JY	AA		R	100 1/16W Metal Oxide
R1806	VRS-CY1 JF222JY	AA		R	2.2k 1/16W Metal Oxide
R1831	VRS-CY1 JF000JY	AA		R	0 1/16W Metal Oxide
R1832	VRS-CY1 JF000JY	AA		R	0 1/16W Metal Oxide
R1833	VRS-CY1 JF000JY	AA		R	0 1/16W Metal Oxide
R1834	VRS-CY1 JF000JY	AA		R	0 1/16W Metal Oxide
R1835	VRS-CY1 JF000JY	AA		R	0 1/16W Metal Oxide
R1836	VRS-CY1 JF000JY	AA		R	0 1/16W Metal Oxide
R1837	VRS-CY1 JF000JY	AA		R	0 1/16W Metal Oxide
R1838	VRS-CY1 JF000JY	AA		R	0 1/16W Metal Oxide
R1839	VRS-CY1 JF000JY	AA		R	0 1/16W Metal Oxide
R1840	VRS-CY1 JF470JY	AA		R	47 1/16W Metal Oxide
R1841	VRS-CY1 JF000JY	AA		R	0 1/16W Metal Oxide
R1842	VRS-CY1 JF101JY	AA		R	100 1/16W Metal Oxide
R1845	VRS-CY1 JF103JY	AA		R	10k 1/16W Metal Oxide
R1846	VRS-CY1 JF104JY	AA		R	100k 1/16W Metal Oxide
R1847	VRS-CY1 JF103JY	AA		R	10k 1/16W Metal Oxide
R1848	VRS-CY1 JF103JY	AA		R	10k 1/16W Metal Oxide
R1851	VRS-CY1 JF000JY	AA		R	0 1/16W Metal Oxide
R1853	VRS-CY1 JF000JY	AA		R	0 1/16W Metal Oxide
R1854	VRS-CY1 JF562JY	AA		R	5.6k 1/16W Metal Oxide
R1855	VRS-CY1 JF000JY	AA		R	0 1/16W Metal Oxide
R1857	VRS-CY1 JF000JY	AA		R	0 1/16W Metal Oxide
R1860	VRS-CY1 JF000JY	AA		R	0 1/16W Metal Oxide
R1862	VRS-CY1 JF101JY	AA		R	100 1/16W Metal Oxide
R1901	VRS-CY1 JF272JY	AA		R	2.7k 1/16W Metal Oxide
R1902	VRS-CY1 JF272JY	AA		R	2.7k 1/16W Metal Oxide
R1903	VRS-CY1 JF152JY	AA		R	1.5k 1/16W Metal Oxide
R1904	VRS-CY1 JF152JY	AA		R	1.5k 1/16W Metal Oxide
R1906	VRS-CY1 JF473JY	AA		R	47k 1/16W Metal Oxide
R1908	VRS-CY1 JF103JY	AA		R	10k 1/16W Metal Oxide
R1909	VRS-CY1 JF473JY	AA		R	47k 1/16W Metal Oxide
R1910	VRS-CY1 JF103JY	AA		R	10k 1/16W Metal Oxide
R1911	VRS-CJ1 JF474JY	AA		R	470k 1/16W Metal Oxide
R1912	VRS-CJ1 JF474JY	AA		R	470k 1/16W Metal Oxide
R1913	VRS-CJ1 JF473JY	AB		R	47k 1/16W Metal Oxide
R1914	VRS-CJ1 JF100JY	AA		R	10 1/16W Metal Oxide
R1915	VRS-CJ1 JF473JY	AB		R	47k 1/16W Metal Oxide
R1916	VRS-CJ1 JF100JY	AA		R	10 1/16W Metal Oxide
R1917	VRS-CY1 JF103JY	AA		R	10k 1/16W Metal Oxide
R1918	VRS-CY1 JF103JY	AA		R	10k 1/16W Metal Oxide
R1919	VRS-CY1 JF100JY	AA		R	10 1/16W Metal Oxide
R1920	VRS-CH1 JF100JY	AA		R	10 1/16W Metal Oxide
R1921	VRS-CH1 JF100JY	AA		R	10 1/16W Metal Oxide
R1922	VRS-CH1 JF100JY	AA		R	10 1/16W Metal Oxide
R1923	VRS-CH1 JF100JY	AA		R	10 1/16W Metal Oxide
R1924	VRS-CH1 JF100JY	AA		R	10 1/16W Metal Oxide
R1925	VRS-CH1 JF100JY	AA		R	10 1/16W Metal Oxide
R1926	VRS-CY1 JF472JY	AA		R	4.7k 1/16W Metal Oxide
R1927	VRS-CH1 JF100JY	AA		R	10 1/16W Metal Oxide
R1928	VRS-CY1 JF223JY	AA		R	22k 1/16W Metal Oxide
R1929	VRS-CY1 JF472JY	AA		R	4.7k 1/16W Metal Oxide
R1930	VRS-CY1 JF910FY	AA		R	91 1/16W Metal Oxide
R1931	VRS-CY1 JF910FY	AA		R	91 1/16W Metal Oxide
R1932	VRS-CY1 JF105JY	AA		R	1M 1/16W Metal Oxide
R1933	VRS-CY1 JF152JY	AA		R	1.5k 1/16W Metal Oxide
R1934	VRS-CJ1 JF101JY	AA		R	100 1/16W Metal Oxide
R1935	VRS-CZ1 JF330JY	AA		R	33 1/16W Metal Oxide
R1937	VRS-CY1 JF103JY	AA		R	10k 1/16W Metal Oxide
R1938	VRS-CZ1 JF220JY	AA		R	22 1/16W Metal Oxide
R1939	VRS-CZ1 JF220JY	AA		R	22 1/16W Metal Oxide
R1940	VRS-CZ1 JF220JY	AA		R	22 1/16W Metal Oxide
R1941	VRS-CZ1 JF220JY	AA		R	22 1/16W Metal Oxide
R1942	VRS-CZ1 JF220JY	AA		R	22 1/16W Metal Oxide
R1943	VRS-CY1 JF000JY	AA		R	0 1/16W Metal Oxide
R1944	VRS-CY1 JF000JY	AA		R	0 1/16W Metal Oxide
R1945	VRS-CY1 JF273JY	AA		R	27k 1/16W Metal Oxide
R2301	VRS-CY1 JF000JY	AA		R	0 1/16W Metal Oxide
R2303	VRS-CY1 JF000JY	AA		R	0 1/16W Metal Oxide
R2305	VRS-CH1 JF103JY	AA		R	10k 1/16W Metal Oxide
R2306	VRS-CY1 JF103JY	AA		R	10k 1/16W Metal Oxide
R2307	VRS-CJ1 JF101JY	AA		R	100 1/16W Metal Oxide
R2308	VRS-CY1 JF104JY	AA		R	100k 1/16W Metal Oxide

NO.	PARTS CODE	PRICE RANK	NEW MARK	PART DELIVERY	DESCRIPTION
[3] DUNTKD915FM01 (MAIN Unit)					
R2309	VRs-CZ1 JF 333 JY	AA		R	33k 1/16W Metal Oxide
R2310	VRs-CY1 JF 103 JY	AA		R	10k 1/16W Metal Oxide
R2311	VRs-CY1 JF 103 JY	AA		R	10k 1/16W Metal Oxide
R2315	VRs-CY1 JF 103 JY	AA		R	10k 1/16W Metal Oxide
R2317	VRs-CZ1 JF 333 JY	AA		R	33k 1/16W Metal Oxide
R2318	VRs-CZ1 JF 333 JY	AA		R	33k 1/16W Metal Oxide
R2319	VRs-CY1 JF 103 JY	AA		R	10k 1/16W Metal Oxide
R2320	VRs-CY1 JF 104 JY	AA		R	100k 1/16W Metal Oxide
R2321	VRs-CY1 JF 101 JY	AA		R	100 1/16W Metal Oxide
R2322	VRs-TW2ED750 JY	AA		R	75 1/4W Metal Oxide
R2324	VRs-TW2ED750 JY	AA		R	75 1/4W Metal Oxide
R2325	VRs-TW2ED750 JY	AA		R	75 1/4W Metal Oxide
R2326	VRs-CY1 JF 102 JY	AA		R	1k 1/16W Metal Oxide
R2329	VRs-CY1 JF 103 JY	AA		R	10k 1/16W Metal Oxide
R2330	VRs-CY1 JF 101 JY	AA		R	100 1/16W Metal Oxide
R2331	VRs-CH1 JF 104 JY	AA		R	100k 1/16W Metal Oxide
R2332	VRs-CY1 JF 473 JY	AA		R	47k 1/16W Metal Oxide
R2333	VRs-CH1 JF 101 JY	AA		R	100 1/16W Metal Oxide
R2334	VRs-CY1 JF 103 JY	AA		R	10k 1/16W Metal Oxide
R2335	VRs-CY1 JF 102 JY	AA		R	1k 1/16W Metal Oxide
R2336	VRs-CY1 JF 222 JY	AA		R	2.2k 1/16W Metal Oxide
R2337	VRs-CY1 JF 103 JY	AA		R	10k 1/16W Metal Oxide
R2338	VRs-CY1 JF 102 JY	AA		R	1k 1/16W Metal Oxide
R2339	VRs-CY1 JF 102FY	AA		R	1k 1/16W Metal Oxide
R2340	VRs-CY1 JF 392 JY	AA		R	3.9k 1/16W Metal Oxide
R2341	VRs-CY1 JF 393FY	AA		R	39k 1/16W Metal Oxide
R2342	VRs-CY1 JF 103 JY	AA		R	10k 1/16W Metal Oxide
R2343	VRs-CY1 JF 333 JY	AA		R	33k 1/16W Metal Oxide
R2347	VRs-CY1 JF 222 JY	AA		R	2.2k 1/16W Metal Oxide
R2349	VRs-CY1 JF 271 JY	AA		R	270 1/16W Metal Oxide
R2350	VRs-CY1 JF 561 JY	AA		R	560 1/16W Metal Oxide
R2351	VRs-CY1 JF 222 JY	AA		R	2.2k 1/16W Metal Oxide
R2352	VRs-CY1 JF 102 JY	AA		R	1k 1/16W Metal Oxide
R2353	VRs-CY1 JF 392 JY	AA		R	3.9k 1/16W Metal Oxide
R2354	VRs-CY1 JF 102 JY	AA		R	1k 1/16W Metal Oxide
R2355	VRs-CY1 JF 271 JY	AA		R	270 1/16W Metal Oxide
R2356	VRs-CY1 JF 822 JY	AA		R	8.2k 1/16W Metal Oxide
R2357	VRs-CY1 JF 473 JY	AA		R	47k 1/16W Metal Oxide
R2358	VRs-CY1 JF 221 JY	AA		R	220 1/16W Metal Oxide
R2359	VRs-CY1 JF 151 JY	AA		R	150 1/16W Metal Oxide
R2360	VRs-CY1 JF 473 JY	AA		R	47k 1/16W Metal Oxide
R2362	VRs-CY1 JF 102 JY	AA		R	1k 1/16W Metal Oxide
R2363	VRs-CY1 JF 102 JY	AA		R	1k 1/16W Metal Oxide
R2364	VRs-CY1 JF 101 JY	AA		R	100 1/16W Metal Oxide
R2365	VRs-CY1 JF 470 JY	AA		R	47 1/16W Metal Oxide
R2366	VRs-CY1 JF 221 JY	AA		R	220 1/16W Metal Oxide
R2367	VRs-CY1 JF 000 JY	AA		R	0 1/16W Metal Oxide
R2368	VRs-CY1 JF 221 JY	AA		R	220 1/16W Metal Oxide
R2370	VRs-CY1 JF 000 JY	AA		R	0 1/16W Metal Oxide
R2371	VRs-CZ1 JF 330 JY	AA		R	33 1/16W Metal Oxide
R2372	VRs-CY1 JF 102 JY	AA		R	1k 1/16W Metal Oxide
R2373	VRs-CY1 JF 000 JY	AA		R	0 1/16W Metal Oxide
R2374	VRs-CY1 JF 102 JY	AA		R	1k 1/16W Metal Oxide
R2375	VRs-CY1 JF 000 JY	AA		R	0 1/16W Metal Oxide
R2376	VRs-CY1 JF 333 JY	AA		R	33k 1/16W Metal Oxide
R2377	VRs-CY1 JF 000 JY	AA		R	0 1/16W Metal Oxide
R2378	VRs-CY1 JF 000 JY	AA		R	0 1/16W Metal Oxide
R2379	VRs-CY1 JF 000 JY	AA		R	0 1/16W Metal Oxide
R2380	VRs-CY1 JF 000 JY	AA		R	0 1/16W Metal Oxide
R2381	VRs-CY1 JF 000 JY	AA		R	0 1/16W Metal Oxide
R2382	VRs-CY1 JF 000 JY	AA		R	0 1/16W Metal Oxide
R2386	VRs-CY1 JF 000 JY	AA		R	0 1/16W Metal Oxide
R2387	VRs-CY1 JF 000 JY	AA		R	0 1/16W Metal Oxide
R2388	VRs-CY1 JF 000 JY	AA		R	0 1/16W Metal Oxide
R2389	VRs-CY1 JF 000 JY	AA		R	0 1/16W Metal Oxide
R2390	VRs-CY1 JF 000 JY	AA		R	0 1/16W Metal Oxide
R2391	VRs-CY1 JF 000 JY	AA		R	0 1/16W Metal Oxide
R2392	VRs-CY1 JF 000 JY	AA		R	0 1/16W Metal Oxide
R2393	VRs-CY1 JF 000 JY	AA		R	0 1/16W Metal Oxide
R2394	VRs-CY1 JF 000 JY	AA		R	0 1/16W Metal Oxide
R2395	VRs-CY1 JF 000 JY	AA		R	0 1/16W Metal Oxide
R2396	VRs-CY1 JF 102 JY	AA		R	1k 1/16W Metal Oxide
R2397	VRs-CY1 JF 102 JY	AA		R	1k 1/16W Metal Oxide
R2398	VRs-CY1 JF 000 JY	AA		R	0 1/16W Metal Oxide
R2415	VRs-CY1 JF 102 JY	AA		R	1k 1/16W Metal Oxide
R2416	VRs-CY1 JF 102 JY	AA		R	1k 1/16W Metal Oxide
R2417	VRs-CY1 JF 102 JY	AA		R	1k 1/16W Metal Oxide
R2702	VRs-CJ1 JF 101 JY	AA		R	100 1/16W Metal Oxide
R2703	VRs-CY1 JF 563 JY	AA		R	56k 1/16W Metal Oxide
R2704	VRs-CY1 JF 470FY	AA		R	47 1/16W Metal Oxide
R2705	VRs-CY1 JF 101 JY	AA		R	100 1/16W Metal Oxide
R2706	VRs-CJ1 JF 224 JY	AA		R	220k 1/16W Metal Oxide
R2707	VRs-CJ1 JF 224 JY	AA		R	220k 1/16W Metal Oxide
R2708	VRs-CH1 JF 104 JY	AA		R	100k 1/16W Metal Oxide
R2709	VRs-CH1 JF 104 JY	AA		R	100k 1/16W Metal Oxide

LC-46/52XD1E-RU

NO.	PARTS CODE	PRICE RANK	NEW MARK	PART DELIVERY	DESCRIPTION
[3] DUNTKD915FM01 (MAIN Unit)					
R2710	VRS-CJ1JF103JY	AA		R	10k 1/16W Metal Oxide
R2711	VRS-CJ1JF103JY	AA		R	10k 1/16W Metal Oxide
R2712	VRS-CJ1JF472JY	AA		R	4.7k 1/16W Metal Oxide
R2713	VRS-CJ1JF472JY	AA		R	4.7k 1/16W Metal Oxide
R2714	VRS-CY1JF123JY	AA		R	12k 1/16W Metal Oxide
R2715	VRS-CY1JF102JY	AA		R	1k 1/16W Metal Oxide
R2716	VRS-CJ1JF103JY	AA		R	10k 1/16W Metal Oxide
R2717	VRS-CZ1JF333JY	AA		R	33k 1/16W Metal Oxide
R2718	VRS-CY1JF000JY	AA		R	0 1/16W Metal Oxide
R2719	VRS-CY1JF102JY	AA		R	1k 1/16W Metal Oxide
R2720	VRS-CY1JF104JY	AA		R	100k 1/16W Metal Oxide
R2721	VRS-CY1JF104JY	AA		R	100k 1/16W Metal Oxide
R2722	VRS-CY1JF000JY	AA		R	0 1/16W Metal Oxide
R2723	VRS-CY1JF000JY	AA		R	0 1/16W Metal Oxide
R2724	VRS-CY1JF000JY	AA		R	0 1/16W Metal Oxide
R2725	VRS-CY1JF000JY	AA		R	0 1/16W Metal Oxide
R2727	VRS-CY1JF000JY	AA		R	0 1/16W Metal Oxide
R2728	VRS-CY1JF000JY	AA		R	0 1/16W Metal Oxide
R2729	VRS-CY1JF000JY	AA		R	0 1/16W Metal Oxide
R2730	VRS-CY1JF000JY	AA		R	0 1/16W Metal Oxide
R2731	VRS-CY1JF000JY	AA		R	0 1/16W Metal Oxide
R2732	VRS-CY1JF000JY	AA		R	0 1/16W Metal Oxide
R2733	VRS-CY1JF000JY	AA		R	0 1/16W Metal Oxide
R2734	VRS-CY1JF000JY	AA		R	0 1/16W Metal Oxide
R2735	VRS-CY1JF000JY	AA		R	0 1/16W Metal Oxide
R2737	VRS-CY1JF104JY	AA		R	100k 1/16W Metal Oxide
R2738	VRS-CY1JF473JY	AA		R	47k 1/16W Metal Oxide
R2739	VRS-CY1JF272JY	AA		R	2.7k 1/16W Metal Oxide
R2740	VRS-CY1JF822JY	AA		R	8.2k 1/16W Metal Oxide
R2741	VRS-CY1JF393JY	AA		R	39k 1/16W Metal Oxide
R2752	VRS-CY1JF472JY	AA		R	4.7k 1/16W Metal Oxide
R2753	VRS-CY1JF472JY	AA		R	4.7k 1/16W Metal Oxide
R2754	VRS-CY1JF103JY	AA		R	10k 1/16W Metal Oxide
R2755	VRS-CY1JF000JY	AA		R	0 1/16W Metal Oxide
R2756	VRS-CY1JF000JY	AA		R	0 1/16W Metal Oxide
R2758	VRS-CY1JF000JY	AA		R	0 1/16W Metal Oxide
R2771	VRS-CY1JF000JY	AA		R	0 1/16W Metal Oxide
R2776	VRS-CY1JF4R7JY	AA		R	4.7 1/16W Metal Oxide
R3001	VRS-CY1JF103JY	AA		R	10k 1/16W Metal Oxide
R3002	VRS-CZ1JF220JY	AA		R	22 1/16W Metal Oxide
R3003	VRS-CY1JF103JY	AA		R	10k 1/16W Metal Oxide
R3004	VRS-CJ1JF101JY	AA		R	100 1/16W Metal Oxide
R3005	VRS-CJ1JF472JY	AA		R	4.7k 1/16W Metal Oxide
R3006	VRS-CY1JF472JY	AA		R	4.7k 1/16W Metal Oxide
R3007	VRS-CY1JF622FY	AA		R	6.2k 1/16W Metal Oxide
R3008	VRS-CJ1JF472JY	AA		R	4.7k 1/16W Metal Oxide
R3009	VRS-CY1JF103JY	AA		R	10k 1/16W Metal Oxide
R3010	VRS-CY1JF472JY	AA		R	4.7k 1/16W Metal Oxide
R3011	VRS-CY1JF104JY	AA		R	100k 1/16W Metal Oxide
R3012	VRS-CY1JF472JY	AA		R	4.7k 1/16W Metal Oxide
R3013	VRS-CY1JF000JY	AA		R	0 1/16W Metal Oxide
R3014	VRS-CY1JF000JY	AA		R	0 1/16W Metal Oxide
R3015	VRS-CY1JF000JY	AA		R	0 1/16W Metal Oxide
R3016	VRS-CY1JF000JY	AA		R	0 1/16W Metal Oxide
R3017	VRS-CY1JF000JY	AA		R	0 1/16W Metal Oxide
R3018	VRS-CY1JF104JY	AA		R	100k 1/16W Metal Oxide
R3019	VRS-CY1JF101JY	AA		R	100 1/16W Metal Oxide
R3021	VRS-CY1JF000JY	AA		R	0 1/16W Metal Oxide
R3022	VRS-CY1JF000JY	AA		R	0 1/16W Metal Oxide
R3024	VRS-CY1JF104JY	AA		R	100k 1/16W Metal Oxide
R3026	VRS-CJ1JF101JY	AA		R	100 1/16W Metal Oxide
R3028	VRS-CY1JF104JY	AA		R	100k 1/16W Metal Oxide
R3029	VRS-CY1JF104JY	AA		R	100k 1/16W Metal Oxide
R3030	VRS-CY1JF104JY	AA		R	100k 1/16W Metal Oxide
R3031	VRS-CY1JF104JY	AA		R	100k 1/16W Metal Oxide
R3032	VRS-CY1JF104JY	AA		R	100k 1/16W Metal Oxide
R3033	VRS-CY1JF104JY	AA		R	100k 1/16W Metal Oxide
R3034	VRS-CY1JF000JY	AA		R	0 1/16W Metal Oxide
R3039	VRS-CY1JF473JY	AA		R	47k 1/16W Metal Oxide
R3040	VRS-CY1JF103JY	AA		R	10k 1/16W Metal Oxide
R3041	VRS-CY1JF000JY	AA		R	0 1/16W Metal Oxide
R3044	VRS-CY1JF000JY	AA		R	0 1/16W Metal Oxide
R3045	VRS-CZ1JF680JY	AB		R	68 1/16W Metal Oxide
R3046	VRS-CZ1JF680JY	AB		R	68 1/16W Metal Oxide
R3047	VRS-CZ1JF680JY	AB		R	68 1/16W Metal Oxide
R3048	VRS-CZ1JF680JY	AB		R	68 1/16W Metal Oxide
R3049	VRS-CZ1JF680JY	AB		R	68 1/16W Metal Oxide
R3050	VRS-CZ1JF680JY	AB		R	68 1/16W Metal Oxide
R3051	VRS-CZ1JF680JY	AB		R	68 1/16W Metal Oxide
R3052	VRS-CZ1JF680JY	AB		R	68 1/16W Metal Oxide
R3053	VRS-CZ1JF680JY	AB		R	68 1/16W Metal Oxide
R3054	VRS-CY1JF000JY	AA		R	0 1/16W Metal Oxide
R3055	VRS-CZ1JF101JY	AA		R	100 1/16W Metal Oxide
R3056	VRS-CZ1JF101JY	AA		R	100 1/16W Metal Oxide
R3057	VRS-CZ1JF101JY	AA		R	100 1/16W Metal Oxide

NO.	PARTS CODE	PRICE RANK	NEW MARK	PART DELIVERY	DESCRIPTION
[3] DUNTKD915FM01 (MAIN Unit)					
R3058	VRS-CZ1JF101JY	AA		R	100 1/16W Metal Oxide
R3059	VRS-CZ1JF101JY	AA		R	100 1/16W Metal Oxide
R3060	VRS-CZ1JF101JY	AA		R	100 1/16W Metal Oxide
R3061	VRS-CZ1JF101JY	AA		R	100 1/16W Metal Oxide
R3062	VRS-CZ1JF101JY	AA		R	100 1/16W Metal Oxide
R3063	VRS-CZ1JF101JY	AA		R	100 1/16W Metal Oxide
R3064	VRS-CY1JF000JY	AA		R	0 1/16W Metal Oxide
R3066	VRS-CY1JF000JY	AA		R	0 1/16W Metal Oxide
R3067	VRS-CY1JF000JY	AA		R	0 1/16W Metal Oxide
R3069	VRS-CZ1JF000JY	AA		R	0 1/16W Metal Oxide
R3070	VRS-CY1JF000JY	AA		R	0 1/16W Metal Oxide
R3301	VRS-CJ1JF101JY	AA		R	100 1/16W Metal Oxide
R3302	VRS-CY1JF103JY	AA		R	10k 1/16W Metal Oxide
R3303	VRS-CY1JF103JY	AA		R	10k 1/16W Metal Oxide
R3304	VRS-CY1JF103JY	AA		R	10k 1/16W Metal Oxide
R3305	VRS-CY1JF103JY	AA		R	10k 1/16W Metal Oxide
R3306	VRS-CY1JF000JY	AA		R	0 1/16W Metal Oxide
R3307	VRS-CY1JF103JY	AA		R	10k 1/16W Metal Oxide
R3308	VRS-CY1JF103JY	AA		R	10k 1/16W Metal Oxide
R3312	VRS-CY1JF102JY	AA		R	1k 1/16W Metal Oxide
R3313	VRS-CZ1JF101JY	AA		R	100 1/16W Metal Oxide
R3314	VRS-CZ1JF101JY	AA		R	100 1/16W Metal Oxide
R3315	VRS-CZ1JF101JY	AA		R	100 1/16W Metal Oxide
R3316	VRS-CZ1JF101JY	AA		R	100 1/16W Metal Oxide
R3317	VRS-CZ1JF101JY	AA		R	100 1/16W Metal Oxide
R3318	VRS-CZ1JF101JY	AA		R	100 1/16W Metal Oxide
R3319	VRS-CZ1JF101JY	AA		R	100 1/16W Metal Oxide
R3320	VRS-CZ1JF101JY	AA		R	100 1/16W Metal Oxide
R3321	VRS-CZ1JF101JY	AA		R	100 1/16W Metal Oxide
R3501	VRK-CD1JJ680JY	AC		R	68 1/16W Metal Composition
R3502	VRS-CY1JF470JY	AA		R	47 1/16W Metal Oxide
R3503	VRS-CH1JF220JY	AA		R	22 1/16W Metal Oxide
R3504	VRS-CZ1JF220JY	AA		R	22 1/16W Metal Oxide
R3505	VRS-CZ1JF333JY	AA		R	33k 1/16W Metal Oxide
R3506	VRS-CZ1JF220JY	AA		R	22 1/16W Metal Oxide
R3507	VRS-CZ1JF102JY	AA		R	1k 1/16W Metal Oxide
R3508	VRS-CZ1JF102JY	AA		R	1k 1/16W Metal Oxide
R3509	VRK-CD1JJ220JY	AC		R	22 1/16W Metal Composition
R3510	VRS-CZ1JF220JY	AA		R	22 1/16W Metal Oxide
R3511	VRS-CZ1JF220JY	AA		R	22 1/16W Metal Oxide
R3512	VRS-CY1JF104JY	AA		R	100k 1/16W Metal Oxide
R3513	VRS-CZ1JF680JY	AB		R	68 1/16W Metal Oxide
R3514	VRS-CY1JF103JY	AA		R	10k 1/16W Metal Oxide
R3515	VRS-CZ1JF680JY	AB		R	68 1/16W Metal Oxide
R3517	VRS-CZ1JF220JY	AA		R	22 1/16W Metal Oxide
R3518	VRK-CD1JJ680JY	AC		R	68 1/16W Metal Composition
R3519	VRS-CZ1JF220JY	AA		R	22 1/16W Metal Oxide
R3520	VRS-CZ1JF220JY	AA		R	22 1/16W Metal Oxide
R3521	VRS-CY1JF102JY	AA		R	1k 1/16W Metal Oxide
R3524	VRK-CD1JJ330JY	AC		R	33 1/16W Metal Composition
R3525	VRK-CD1JJ330JY	AC		R	33 1/16W Metal Composition
R3526	VRK-CD1JJ330JY	AC		R	33 1/16W Metal Composition
R3527	VRK-CD1JJ330JY	AC		R	33 1/16W Metal Composition
R3532	VRS-CZ1JF220JY	AA		R	22 1/16W Metal Oxide
R3533	VRK-CD1JJ151JY	AC		R	150 1/16W Metal Composition
R3534	VRK-CD1JJ151JY	AC		R	150 1/16W Metal Composition
R3535	VRK-CD1JJ151JY	AC		R	150 1/16W Metal Composition
R3536	VRK-CD1JJ151JY	AC		R	150 1/16W Metal Composition
R3537	VRS-CZ1JF333JY	AA		R	33k 1/16W Metal Oxide
R3540	VRS-CZ1JF333JY	AA		R	33k 1/16W Metal Oxide
R3541	VRS-CZ1JF220JY	AA		R	22 1/16W Metal Oxide
R3542	VRK-CD1JJ330JY	AC		R	33 1/16W Metal Composition
R3543	VRK-CD1JJ330JY	AC		R	33 1/16W Metal Composition
R3544	VRK-CD1JJ330JY	AC		R	33 1/16W Metal Composition
R3545	VRK-CD1JJ330JY	AC		R	33 1/16W Metal Composition
R3550	VRS-CZ1JF220JY	AA		R	22 1/16W Metal Oxide
R3551	VRS-CZ1JF330JY	AA		R	33 1/16W Metal Oxide
R3552	VRS-CZ1JF330JY	AA		R	33 1/16W Metal Oxide
R3553	VRS-CZ1JF330JY	AA		R	33 1/16W Metal Oxide
R3554	VRS-CZ1JF330JY	AA		R	33 1/16W Metal Oxide
R3557	VRS-CZ1JF333JY	AA		R	33k 1/16W Metal Oxide
R3559	VRS-CZ1JF333JY	AA		R	33k 1/16W Metal Oxide
R3560	VRS-CY1JF221JY	AA		R	220 1/16W Metal Oxide
R3561	VRS-CY1JF000JY	AA		R	0 1/16W Metal Oxide
R3562	VRS-CZ1JF333JY	AA		R	33k 1/16W Metal Oxide
R3563	VRS-CZ1JF333JY	AA		R	33k 1/16W Metal Oxide
R3564	VRS-CZ1JF333JY	AA		R	33k 1/16W Metal Oxide
R3567	VRS-CY1JF151JY	AA		R	150 1/16W Metal Oxide
R3568	VRS-CY1JF151JY	AA		R	150 1/16W Metal Oxide
R3569	VRS-CY1JF151JY	AA		R	150 1/16W Metal Oxide
R3570	VRS-CY1JF151JY	AA		R	150 1/16W Metal Oxide
R3571	VRS-CZ1JF000JY	AA		R	0 1/16W Metal Oxide
R3575	VRS-CH1JF680JY	AA		R	68 1/16W Metal Oxide
R3580	VRS-CZ1JF330JY	AA		R	33 1/16W Metal Oxide
R3581	VRS-CZ1JF330JY	AA		R	33 1/16W Metal Oxide

LC-46/52XD1E-RU

NO.	PARTS CODE	PRICE RANK	NEW MARK	PART DELIVERY	DESCRIPTION
[3] DUNTKD915FM01 (MAIN Unit)					
R3582	VRS-CZ1JF330JY	AA		R	33 1/16W Metal Oxide
R3583	VRS-CZ1JF330JY	AA		R	33 1/16W Metal Oxide
R3588	VRS-CY1JF151JY	AA		R	150 1/16W Metal Oxide
R3589	VRS-CY1JF151JY	AA		R	150 1/16W Metal Oxide
R3590	VRS-CY1JF151JY	AA		R	150 1/16W Metal Oxide
R3591	VRS-CY1JF151JY	AA		R	150 1/16W Metal Oxide
R3592	VRS-CZ1JF330JY	AA		R	33 1/16W Metal Oxide
R3593	VRS-CZ1JF330JY	AA		R	33 1/16W Metal Oxide
R3594	VRS-CZ1JF330JY	AA		R	33 1/16W Metal Oxide
R3595	VRS-CZ1JF330JY	AA		R	33 1/16W Metal Oxide
R3596	VRS-CY1JF000JY	AA		R	0 1/16W Metal Oxide
R3597	VRS-CY1JF333JY	AA		R	33k 1/16W Metal Oxide
R3701	VRS-CY1JF101JY	AA		R	100 1/16W Metal Oxide
R3702	VRS-CY1JF101JY	AA		R	100 1/16W Metal Oxide
R3703	VRS-CY1JF101JY	AA		R	100 1/16W Metal Oxide
R3704	VRS-CY1JF182JY	AA		R	1.8k 1/16W Metal Oxide
R3705	VRS-CY1JF182JY	AA		R	1.8k 1/16W Metal Oxide
R3706	VRS-CY1JF182JY	AA		R	1.8k 1/16W Metal Oxide
R3708	VRS-CY1JF105JY	AA		R	1M 1/16W Metal Oxide
R3712	VRS-CY1JF000JY	AA		R	0 1/16W Metal Oxide
R3713	VRS-CY1JF000JY	AA		R	0 1/16W Metal Oxide
R3714	VRS-CY1JF000JY	AA		R	0 1/16W Metal Oxide
R3715	VRS-CY1JF000JY	AA		R	0 1/16W Metal Oxide
R3716	VRS-CY1JF101JY	AA		R	100 1/16W Metal Oxide
R3717	VRS-CY1JF101JY	AA		R	100 1/16W Metal Oxide
R3718	VRS-CY1JF101JY	AA		R	100 1/16W Metal Oxide
R3719	VRS-CY1JF101JY	AA		R	100 1/16W Metal Oxide
R3720	VRS-CY1JF101JY	AA		R	100 1/16W Metal Oxide
R3721	VRS-CY1JF101JY	AA		R	100 1/16W Metal Oxide
R3722	VRS-CY1JF101JY	AA		R	100 1/16W Metal Oxide
R3723	VRS-CY1JF101JY	AA		R	100 1/16W Metal Oxide
R3724	VRS-CY1JF101JY	AA		R	100 1/16W Metal Oxide
R3725	VRS-CY1JF101JY	AA		R	100 1/16W Metal Oxide
R3726	VRS-CY1JF101JY	AA		R	100 1/16W Metal Oxide
R3727	VRS-CY1JF101JY	AA		R	100 1/16W Metal Oxide
R3728	VRS-CY1JF101JY	AA		R	100 1/16W Metal Oxide
R3729	VRS-CY1JF101JY	AA		R	100 1/16W Metal Oxide
R3730	VRS-CY1JF101JY	AA		R	100 1/16W Metal Oxide
R3731	VRS-CY1JF101JY	AA		R	100 1/16W Metal Oxide
R3735	VRS-CY1JF332JY	AA		R	3.3k 1/16W Metal Oxide
R3736	VRS-CY1JF332JY	AA		R	3.3k 1/16W Metal Oxide
R3737	VRS-CY1JF332JY	AA		R	3.3k 1/16W Metal Oxide
R3738	VRS-CY1JF103JY	AA		R	10k 1/16W Metal Oxide
R3739	VRS-CY1JF103JY	AA		R	10k 1/16W Metal Oxide
R3740	VRS-CY1JF103JY	AA		R	10k 1/16W Metal Oxide
R3741	VRS-CY1JF000JY	AA		R	0 1/16W Metal Oxide
R3742	VRS-CY1JF101JY	AA		R	100 1/16W Metal Oxide
R3743	VRS-CY1JF470JY	AA		R	47 1/16W Metal Oxide
R3744	VRS-CY1JF470JY	AA		R	47 1/16W Metal Oxide
R3745	VRS-CY1JF512JY	AA		R	5.1k 1/16W Metal Oxide
R3746	VRS-CY1JF101JY	AA		R	100 1/16W Metal Oxide
R3747	VRS-CY1JF101JY	AA		R	100 1/16W Metal Oxide
R3748	VRS-CY1JF000JY	AA		R	0 1/16W Metal Oxide
R3749	VRS-CY1JF000JY	AA		R	0 1/16W Metal Oxide
R3750	VRS-CY1JF000JY	AA		R	0 1/16W Metal Oxide
R3751	VRS-CY1JF103JY	AA		R	10k 1/16W Metal Oxide
R3752	VRS-CY1JF000JY	AA		R	0 1/16W Metal Oxide
S3001	QSW-K0095CEZZ	AB		R	Switch
S3501	QSW-SA020WJZZY	AE		R	Switch
SC1701	QCNCWA251WJZZY	AH		R	Connector
SC1702	QCNCWA248WJZZY	AD		R	Connector
SC1901	QSOCZA072WJZZQ	AH		R	Socket
SC1902	QSOCZA072WJZZQ	AH		R	Socket
SC2301	QSOCDA036WJZZ	AF		R	Socket
SC2302	QCNCWA507WJQZY	AM		R	Connector
SC2303	QSOCNA229WJZZ	AH		R	Socket
SC2702	QCNCWA251WJZZY	AH		R	Connector
SC2703	QCNCWA251WJZZY	AH		R	Connector
SC2704	QCNCWA251WJZZY	AH		R	Connector
SC2705	QCNCWA010WJZZY	AE		R	Connector
SC2707	QCNCWA251WJZZY	AH		R	Connector
TH3001	VHBM103J03-1Y	AC		R	Thermistor
X1901	RCRSCA108WJZZY	AF		R	Crystal
X3001	RCRSC0012CEZZY	AH		R	Crystal
X3301	RCRSC0012CEZZY	AH		R	Crystal
X3701	RCRSB0250GEZZ+	AG		R	Crystal

NO.	PARTS CODE	PRICE RANK	NEW MARK	PART DELIVERY	DESCRIPTION
[4] DUNTKD604FM11 (AV UNIT)					
C301	VCKYCY1HB392KY	AA		R	3900p 50V Ceramic
C302	VCKYCY1HB392KY	AA		R	3900p 50V Ceramic
C303	VCKYCY1HF224ZY	AA		R	0.22 50V Ceramic
C304	VCKYCY1HF224ZY	AA		R	0.22 50V Ceramic
C305	VCKYCY1HB104KY	AA		R	0.1 50V Ceramic
C306	VCEASX1HN225MY	AB		R	2.2 50V Electrolytic
C307	VCEASX1HN225MY	AB		R	2.2 50V Electrolytic
C308	VCKYCY1HB104KY	AA		R	0.1 50V Ceramic
C309	VCKYCY1HB222KY	AA		R	2200p 50V Ceramic
C310	VCKYCY1HB222KY	AA		R	2200p 50V Ceramic
C311	VCEASX1CN226MY	AC		R	22 16V Electrolytic
C312	VCKYCY1HB222KY	AA		R	2200p 50V Ceramic
C313	VCKYCY1HB222KY	AA		R	2200p 50V Ceramic
C314	VCKYCY1HB153KY	AA		R	0.015 50V Ceramic
C315	VCKYCY1HB153KY	AA		R	0.015 50V Ceramic
C316	VCCCY1HH330JY	AA		R	33p 50V Ceramic
C317	VCCCY1HH330JY	AA		R	33p 50V Ceramic
C318	VCCCY1HH470JY	AA		R	47p 50V Ceramic
C319	VCCCY1HH470JY	AA		R	47p 50V Ceramic
C320	VCEASX1HN225MY	AB		R	2.2 50V Electrolytic
C321	VCEASX1HN225MY	AB		R	2.2 50V Electrolytic
C322	VCKYCY1HF224ZY	AA		R	0.22 50V Ceramic
C323	VCKYCY1HF224ZY	AA		R	0.22 50V Ceramic
C324	VCEASX1HN106MY	AC		R	10 50V Electrolytic
C325	VCEASX1HN106MY	AC		R	10 50V Electrolytic
C326	VCKYCY1HB153KY	AA		R	0.015 50V Ceramic
C327	VCKYCY1HB153KY	AA		R	0.015 50V Ceramic
C328	VCEASX1HN225MY	AB		R	2.2 50V Electrolytic
C329	VCEASX1HN225MY	AB		R	2.2 50V Electrolytic
C330	VCEASY1VM477M+	AF		R	470 35V Capacitor(AL)
C331	VCEASY1VM477M+	AF		R	470 35V Capacitor(AL)
C332	VCKYCY1HB221KY	AA		R	220p 50V Ceramic
C333	VCKYCY1HB221KY	AA		R	220p 50V Ceramic
C334	VCKYCY1HB221KY	AA		R	220p 50V Ceramic
C335	VCKYCY1HB221KY	AA		R	220p 50V Ceramic
C338	RC-EZA513WJZZ	AH		R	Capacitor
C339	RC-EZA513WJZZ	AH		R	Capacitor
C340	VCKYTV1EB224KY	AA		R	0.22 25V Ceramic
C341	VCKYTV1EB224KY	AA		R	0.22 25V Ceramic
C342	VCFYFA1HA684J+	AC		R	0.68 50V Capacitor
C343	VCFYFA1HA684J+	AC		R	0.68 50V Capacitor
C346	VCEASX1HN105MY	AB		R	1 50V Electrolytic
C347	VCEASX1HN105MY	AB		R	1 50V Electrolytic
C348	VCEASX1VN226MY	AC		R	22 35V Electrolytic
C349	VCEASX1VN226MY	AC		R	22 35V Electrolytic
C350	VCKYCY1HB103KY	AA		R	0.01 50V Ceramic
C351	VCKYCY1HB103KY	AA		R	0.01 50V Ceramic
C352	VCKYCY1HB103KY	AA		R	0.01 50V Ceramic
C353	VCKYCY1HB103KY	AA		R	0.01 50V Ceramic
C354	VCKYCY1HB102KY	AA		R	1000p 50V Ceramic
C355	VCKYCY1HB102KY	AA		R	1000p 50V Ceramic
C356	VCEASY1HN476MY	AD		R	47 50V Electrolytic
C357	VCEASY1HN476MY	AD		R	47 50V Electrolytic
C358	VCEASX1HN106MY	AC		R	10 50V Electrolytic
C359	VCEASX1HN106MY	AC		R	10 50V Electrolytic
C360	VCEASY1CN476MY	AC		R	47 16V Electrolytic
C361	RC-KZA073WJZZY	AD		R	Capacitor
C362	VCKYTV1EB224KY	AA		R	0.22 25V Ceramic
C363	VCKYTV1EB224KY	AA		R	0.22 25V Ceramic
C364	VCEASY1CN477MY	AD		R	470 16V Electrolytic
C365	VCKYCY1HB222KY	AA		R	2200p 50V Ceramic
C366	VCKYCY1HB222KY	AA		R	2200p 50V Ceramic
C1101	VCKYTV1EB104KY	AB		R	0.1 25V Ceramic
C1102	VCKYTV1EB104KY	AB		R	0.1 25V Ceramic
C1103	VCKYTV1EB104KY	AB		R	0.1 25V Ceramic
C1104	VCCCY1HH101JY	AA		R	100p 50V Ceramic
C1105	VCKYTV1EB104KY	AB		R	0.1 25V Ceramic
C1106	VCKYTV1EB104KY	AB		R	0.1 25V Ceramic
C1107	VCKYTV1EB104KY	AB		R	0.1 25V Ceramic
C1108	VCCCY1HH101JY	AA		R	100p 50V Ceramic
C1109	VCKYTV1EB104KY			R	0.1 50V Ceramic
C1110	VCKYTV1EB104KY			R	0.1 50V Ceramic
C1114	VCKYCY1HB221KY	AA		R	220p 50V Ceramic
C1116	VCKYCY1HB221KY	AA		R	220p 50V Ceramic
C1117	VCCCY1HH101JY	AA		R	100p 50V Ceramic
C1118	VCCCY1HH101JY	AA		R	100p 50V Ceramic
C1119	VCKYCY1HB102KY	AA		R	1000p 50V Ceramic
C1120	VCKYCY1HB102KY	AA		R	1000p 50V Ceramic
C1121	VCKYTV1CB105KY	AC		R	1 16V Ceramic
C1122	VCKYCY1HB331KY	AA		R	330p 50V Ceramic
C1123	VCKYCY1HB331KY	AA		R	330p 50V Ceramic
C1124	VCKYTV1CB105KY	AC		R	1 16V Ceramic
C1125	VCKYCY1HB471KY	AA		R	470p 50V Ceramic
C1126	VCKYCY1HB471KY	AA		R	470p 50V Ceramic
C1127	VCCCY1HH101JY	AA		R	100p 50V Ceramic

NO.	PARTS CODE	PRICE RANK	NEW MARK	PART DELIVERY	DESCRIPTION
[4] DUNTKD604FM11 (AV UNIT)					
C1128	VCCCCY1HH101JY	AA		R	100p 50V Ceramic
C1130	VCEASY1CN477MY	AD		R	470 16V Electrolytic
C1131	VCKYCY1HF103ZY	AA		R	0.01 50V Ceramic
C1132	RC-KZA073WJZZY	AD		R	Capacitor
C1133	RC-KZA073WJZZY	AD		R	Capacitor
C1134	VCKYCY1HB102KY	AA		R	1000p 50V Ceramic
C1135	VCKYCY1HB102KY	AA		R	1000p 50V Ceramic
C1136	RC-KZA073WJZZY	AD		R	Capacitor
C1137	RC-KZA073WJZZY	AD		R	Capacitor
C1138	VCKYTV1CB105KY	AC		R	1 16V Ceramic
C1139	VCKYCY1HB331KY	AA		R	330p 50V Ceramic
C1140	VCKYCY1HB331KY	AA		R	330p 50V Ceramic
C1142	VCKYTV1CB105KY	AC		R	1 16V Ceramic
C1143	VCKYCY1HB471KY	AA		R	470p 50V Ceramic
C1144	VCKYCY1HB471KY	AA		R	470p 50V Ceramic
C1145	RC-KZA073WJZZY	AD		R	Capacitor
C1146	RC-KZA073WJZZY	AD		R	Capacitor
C1147	VCKYCY1EF104ZY	AA		R	0.1 25V Ceramic
C1148	RC-KZA073WJZZY	AD		R	Capacitor
C1157	RC-KZA073WJZZY	AD		R	Capacitor
C1158	RC-KZA073WJZZY	AD		R	Capacitor
C1159	VCKYCY1HF103ZY	AA		R	0.01 50V Ceramic
C1160	VCKYCY1EF104ZY	AA		R	0.1 25V Ceramic
C1161	RC-KZA073WJZZY	AD		R	Capacitor
C1162	VCEASY1CN477MY	AD		R	470 16V Electrolytic
C1201	VCKYCY1HB102KY	AA		R	1000p 50V Ceramic
C1202	VCKYCY1HF103ZY	AA		R	0.01 50V Ceramic
C1203	VCCCCY1HH101JY	AA		R	100p 50V Ceramic
C1204	VCCCCY1HH100DY	AA		R	10p 50V Ceramic
C1205	RC-KZA073WJZZY	AD		R	Capacitor
C1206	VCCCCY1HH101JY	AA		R	100p 50V Ceramic
C1207	VCCCCY1HH100DY	AA		R	10p 50V Ceramic
C1208	RC-KZA073WJZZY	AD		R	Capacitor
C1210	VCCCCY1HH101JY	AA		R	100p 50V Ceramic
C1211	VCKYCY1HB102KY	AA		R	1000p 50V Ceramic
C1212	VCKYTV1CB105KY	AC		R	1 16V Ceramic
C1216	VCCCCY1HH101JY	AA		R	100p 50V Ceramic
C1217	VCKYCY1HB102KY	AA		R	1000p 50V Ceramic
C1218	VCKYTV1CB105KY	AC		R	1 16V Ceramic
C1219	VCEASY1CN476MY	AC		R	47 16V Electrolytic
C1220	RC-KZA073WJZZY	AD		R	Capacitor
C1221	RC-KZA073WJZZY	AD		R	Capacitor
C1222	RC-KZA073WJZZY	AD		R	Capacitor
C1223	RC-KZA073WJZZY	AD		R	Capacitor
C1224	VCCCCY1HH101JY	AA		R	100p 50V Ceramic
C1225	VCCCCY1HH101JY	AA		R	100p 50V Ceramic
C1251	VCEASX1CN107MY	AC		R	100 16V Electrolytic
C1252	VCKYTV1CB105KY	AC		R	1 16V Ceramic
C1253	VCKYCY1EF104ZY	AA		R	0.1 25V Ceramic
D306	VHD1SS390+-1Y	AB		R	1SS390TE61
D307	VHD1SS390+-1Y	AB		R	1SS390TE61
D308	VHD1SS390+-1Y	AB		R	1SS390TE61
D309	VHD1SS390+-1Y	AB		R	1SS390TE61
D310	VHD1SS390+-1Y	AB		R	1SS390TE61
D311	RH-EXA103WJZZY	AB		R	UDZSTE-1736B
D312	RH-EXA103WJZZY	AB		R	UDZSTE-1736B
D313	RH-EX1026CEZZY			R	
D314	RH-EX1295CEZZY	AB		R	HZU30BTRF-E
D315	RH-EX1295CEZZY	AB		R	HZU30BTRF-E
D316	RH-EX1295CEZZY	AB		R	HZU30BTRF-E
D317	RH-EX1295CEZZY	AB		R	HZU30BTRF-E
D318	VHD1SS390+-1Y	AB		R	1SS390TE61
D1101	RH-EX1068CEZZY			R	
D1102	RH-EX1026CEZZY			R	
D1103	RH-EX1026CEZZY			R	
D1104	RH-EX1068CEZZY			R	
D1105	RH-EX1064CEZZY			R	
D1106	RH-EX1034CEZZY			R	
D1107	RH-EX1034CEZZY			R	
D1108	RH-EX1064CEZZY			R	
D1109	RH-EX1049CEZZY			R	
D1110	RH-EX1049CEZZY			R	
D1111	RH-EX1049CEZZY			R	
D1112	RH-EX1049CEZZY			R	
D1113	RH-EX1034CEZZY			R	
D1114	RH-EX1034CEZZY			R	
D1115	RH-EX1034CEZZY			R	
D1116	RH-EX1034CEZZY			R	
D1117	RH-EX1034CEZZY			R	
D1118	RH-EX1026CEZZY			R	
D1119	RH-EX1026CEZZY			R	
D1120	RH-EX1026CEZZY			R	
D1121	RH-EX1026CEZZY			R	
D1122	RH-EX1026CEZZY			R	
D1123	RH-EX1026CEZZY			R	

NO.	PARTS CODE	PRICE RANK	NEW MARK	PART DELIVERY	DESCRIPTION
[4] DUNTKD604FM11 (AV UNIT)					
D1201	RH-EX1239CEZZY	AB		R	
FB1101	RBLN-0062TAZZY	AB		R	Balun
FB1102	RBLN-0062TAZZY	AB		R	Balun
FB1103	RBLN-0077TAZZY	AB		R	Balun
FB1104	RBLN-0077TAZZY	AB		R	Balun
FB1105	RBLN-0051TAZZY	AC		R	Balun
FB1106	RBLN-0062TAZZY	AB		R	Balun
FB1107	RBLN-0051TAZZY	AC		R	Balun
FB1108	RBLN-0062TAZZY	AB		R	Balun
FB1109	RBLN-0062TAZZY	AB		R	Balun
FB1110	RBLN-0062TAZZY	AB		R	Balun
FB1111	RBLN-0051TAZZY	AC		R	Balun
FB1112	RBLN-0051TAZZY	AC		R	Balun
FB1201	RBLN-0051TAZZY	AC		R	Balun
FB1202	RBLN-0051TAZZY	AC		R	Balun
FB1203	RBLN-0062TAZZY	AB		R	Balun
FB1204	RBLN-0062TAZZY	AB		R	Balun
FB1213	RBLN-0210TAZZY	AB		R	Balun
FB1218	RBLN-0254TAZZY	AB		R	Balun
FL1101	RF i LN0017TAZZY	AC		R	Filter
FL1102	RF i LN0017TAZZY	AC		R	Filter
FL1103	RF i LN0017TAZZY	AC		R	Filter
FL1104	RF i LN0017TAZZY	AC		R	Filter
FL1105	RF i LN0017TAZZY	AC		R	Filter
FL1106	RF i LN0017TAZZY	AC		R	Filter
FL1107	RF i LN0017TAZZY	AC		R	Filter
FL1108	RF i LN0017TAZZY	AC		R	Filter
FL1109	RF i LN0017TAZZY	AC		R	Filter
FL1110	RF i LN0017TAZZY	AC		R	Filter
FL1211	RF i LN0017TAZZY	AC		R	Filter
FL1212	RF i LN0017TAZZY	AC		R	Filter
iC301	VH i TDA8931T-1Y	AS		R	TDA8931T/N1,118
iC302	VH i TDA8931T-1Y	AS		R	TDA8931T/N1,118
iC303	VH i NJM4558M-1Y	AD		R	NJM4558M-TE1
IC1101	VH i MM1506XN-1Y	AD		R	MM1506XNRE
IC1102	VH i MM1506XN-1Y	AD		R	MM1506XNRE
IC1201	VH i MM1507XN-1Y	AD		R	MM1507XNRE
J1101	QSOCZA116WJZZ	AK		R	Socket
J1201	QJAKZA033WJZZ	AK		R	Jack
J1301	QJAKJA007WJZZ	AD		R	Jack
L301	RC i LPA697WJZZ	AE		R	Coil
L302	RC i LPA697WJZZ	AE		R	Coil
LUG301	QLUGHA009WJZZY	AC		R	Lug
LUG302	QLUGHA009WJZZY	AC		R	Lug
LUG303	QLUGHA009WJZZY	AC		R	Lug
LUG304	QLUGHA009WJZZY	AC		R	Lug
P301	QPLGNA173WJZZY	AD		R	Plug
P1101	QCNCMA250WJZZ	AE		R	Connector
P1102	QCNCMA250WJZZ	AE		R	Connector
P1201	QCNCMA250WJZZ	AE		R	Connector
Q301	VS2SC3928AR-1Y	AB		R	2SC3928A-T112-1R
Q302	VS2SC3928AR-1Y	AB		R	2SC3928A-T112-1R
Q303	VSDTC314TK/-1Y	AC		R	DTC314TKT146
Q304	VSDTC314TK/-1Y	AC		R	DTC314TKT146
Q305	VSDTC314TK/-1Y	AC		R	DTC314TKT146
Q306	VSDTC314TK/-1Y	AC		R	DTC314TKT146
Q307	VS2SA1530AR-1Y	AB		R	2SA1530A-T112-1R
Q1101	VSDTC314TK/-1Y	AC		R	DTC314TKT146
Q1102	VSDTC314TK/-1Y	AC		R	DTC314TKT146
Q1103	VS2SA1530AR-1Y	AB		R	2SA1530A-T112-1R
Q1104	VS2SA1530AR-1Y	AB		R	2SA1530A-T112-1R
Q1105	VSDTC314TK/-1Y	AC		R	DTC314TKT146
Q1106	VSDTC314TK/-1Y	AC		R	DTC314TKT146
Q1107	VS2SA1530AR-1Y	AB		R	2SA1530A-T112-1R
Q1108	VS2SA1530AR-1Y	AB		R	2SA1530A-T112-1R
Q1201	VS2SA1530AR-1Y	AB		R	2SA1530A-T112-1R
Q1202	VS2SA1530AR-1Y	AB		R	2SA1530A-T112-1R
Q1203	VSDTC314TK/-1Y	AC		R	DTC314TKT146
Q1204	VSDTC314TK/-1Y	AC		R	DTC314TKT146
R301	VRS-CJ1JF102JY	AA		R	1k 1/16W Metal Oxide
R302	VRS-CJ1JF104JY	AA		R	100k 1/16W Metal Oxide
R303	VRS-CY1JF222JY	AA		R	2.2k 1/16W Metal Oxide
R304	VRS-CY1JF222JY	AA		R	2.2k 1/16W Metal Oxide
R305	VRS-CY1JF222JY	AA		R	2.2k 1/16W Metal Oxide
R306	VRS-CJ1JF472JY	AA		R	4.7k 1/16W Metal Oxide
R307	VRS-CJ1JF104JY	AA		R	100k 1/16W Metal Oxide
R308	VRS-CY1JF473JY	AA		R	47k 1/16W Metal Oxide
R309	VRS-CY1JF473JY	AA		R	47k 1/16W Metal Oxide
R310	VRS-CY1JF102JY	AA		R	1k 1/16W Metal Oxide
R311	VRS-CY1JF102JY	AA		R	1k 1/16W Metal Oxide
R312	VRS-CY1JF102JY	AA		R	1k 1/16W Metal Oxide
R313	VRS-CY1JF102JY	AA		R	1k 1/16W Metal Oxide
R314	VRS-CY1JF392JY	AA		R	3.9k 1/16W Metal Oxide
R315	VRS-CY1JF474JY	AA		R	470k 1/16W Metal Oxide
R316	VRS-CY1JF392JY	AA		R	3.9k 1/16W Metal Oxide

NO.	PARTS CODE	PRICE RANK	NEW MARK	PART DELIVERY	DESCRIPTION
[4] DUNTKD604FM11 (AV UNIT)					
R317	VRS-CY1JF474JY	AA		R	470k 1/16W Metal Oxide
R318	VRS-TW2HF820JY	AB		R	82 1/2W Metal Oxide
R319	VRS-CY1JF122JY	AA		R	1.2k 1/16W Metal Oxide
R320	VRS-CY1JF122JY	AA		R	1.2k 1/16W Metal Oxide
R321	VRS-CY1JF103JY	AA		R	10k 1/16W Metal Oxide
R322	VRS-CY1JF103JY	AA		R	10k 1/16W Metal Oxide
R323	VRS-CY1JF473JY	AA		R	47k 1/16W Metal Oxide
R324	VRS-CY1JF473JY	AA		R	47k 1/16W Metal Oxide
R325	VRS-CY1JF152JY	AA		R	1.5k 1/16W Metal Oxide
R326	VRS-CY1JF152JY	AA		R	1.5k 1/16W Metal Oxide
R327	VRS-CJ1JF103JY	AA		R	10k 1/16W Metal Oxide
R328	VRS-CJ1JF392JY	AA		R	3.9k 1/16W Metal Oxide
R329	VRS-CY1JF682JY	AA		R	6.8k 1/16W Metal Oxide
R330	VRS-CY1JF222JY	AA		R	2.2k 1/16W Metal Oxide
R331	VRS-CY1JF222JY	AA		R	2.2k 1/16W Metal Oxide
R333	VRS-CJ1JF103JY	AA		R	10k 1/16W Metal Oxide
R334	VRS-CY1JF682JY	AA		R	6.8k 1/16W Metal Oxide
R335	VRS-TW2ED100JY	AA		R	10 1/4W Metal Oxide
R336	VRS-TW2ED100JY	AA		R	10 1/4W Metal Oxide
R337	VRS-TW2ED100JY	AA		R	10 1/4W Metal Oxide
R338	VRS-TW2ED100JY	AA		R	10 1/4W Metal Oxide
R339	VRS-TW2ED220JY	AB		R	22 1/4W Metal Oxide
R340	VRS-TW2ED220JY	AB		R	22 1/4W Metal Oxide
R343	VRS-TW2ED000JY	AB		R	0 1/4W Metal Oxide
R345	VRS-CJ1JF103JY	AA		R	10k 1/16W Metal Oxide
R346	VRS-CY1JF560JY	AA		R	56 1/16W Metal Oxide
R347	VRS-CY1JF560JY	AA		R	56 1/16W Metal Oxide
R348	VRS-CJ1JF222JY	AA		R	2.2k 1/16W Metal Oxide
R349	VRS-CY1JF221JY	AA		R	220 1/16W Metal Oxide
R350	VRS-CY1JF221JY	AA		R	220 1/16W Metal Oxide
R351	VRS-CY1JF103JY	AA		R	10k 1/16W Metal Oxide
R352	VRS-CY1JF103JY	AA		R	10k 1/16W Metal Oxide
R353	VRS-CY1JF102JY	AA		R	1k 1/16W Metal Oxide
R354	VRS-CY1JF102JY	AA		R	1k 1/16W Metal Oxide
R355	VRS-TW2ED2R7JY	AB		R	2.7 1/4W Metal Oxide
R356	VRS-CY1JF103JY	AA		R	10k 1/16W Metal Oxide
R358	VRS-CY1JF000JY	AA		R	0 1/16W Metal Oxide
R360	VRS-CY1JF472JY	AA		R	4.7k 1/16W Metal Oxide
R1101	VRS-CY1JF153FY	AA		R	15k 1/16W Metal Oxide
R1102	VRS-CY1JF153FY	AA		R	15k 1/16W Metal Oxide
R1103	VRS-CY1JF393FY	AA		R	39k 1/16W Metal Oxide
R1104	VRS-CY1JF000JY	AA		R	0 1/16W Metal Oxide
R1105	VRS-CY1JF000JY	AA		R	0 1/16W Metal Oxide
R1106	VRS-CY1JF000JY	AA		R	0 1/16W Metal Oxide
R1107	VRS-TV1JD221JY	AA		R	220 1/16W Metal Oxide
R1108	VRS-CY1JF393FY	AA		R	39k 1/16W Metal Oxide
R1109	VRS-TV1JD221JY	AA		R	220 1/16W Metal Oxide
R1110	VRS-CY1JF000JY	AA		R	0 1/16W Metal Oxide
R1111	VRS-TW2ED680JY	AA		R	68 1/4W Metal Oxide
R1112	VRS-TW2ED680JY	AA		R	68 1/4W Metal Oxide
R1113	VRS-TW2ED750JY	AA		R	75 1/4W Metal Oxide
R1114	VRS-TW2ED750JY	AA		R	75 1/4W Metal Oxide
R1115	VRS-CY1JF000JY	AA		R	0 1/16W Metal Oxide
R1116	VRS-TW2ED750JY	AA		R	75 1/4W Metal Oxide
R1117	VRS-TW2ED750JY	AA		R	75 1/4W Metal Oxide
R1118	VRS-TW2ED750JY	AA		R	75 1/4W Metal Oxide
R1119	VRS-TW2ED101JY	AA		R	100 1/4W Metal Oxide
R1120	VRS-CY1JF000JY	AA		R	0 1/16W Metal Oxide
R1121	VRS-TW2ED750JY	AA		R	75 1/4W Metal Oxide
R1123	VRS-TW2ED750JY	AA		R	75 1/4W Metal Oxide
R1125	VRS-TW2ED750JY	AA		R	75 1/4W Metal Oxide
R1126	VRS-CY1JF000JY	AA		R	0 1/16W Metal Oxide
R1127	VRS-TW2ED750JY	AA		R	75 1/4W Metal Oxide
R1128	VRS-TW2ED101JY	AA		R	100 1/4W Metal Oxide
R1129	VRS-TW2ED750JY	AA		R	75 1/4W Metal Oxide
R1130	VRS-CY1JF000JY	AA		R	0 1/16W Metal Oxide
R1131	VRS-CY1JF221JY	AA		R	220 1/16W Metal Oxide
R1134	VRS-CY1JF102JY	AA		R	1k 1/16W Metal Oxide
R1137	VRS-CY1JF000JY	AA		R	0 1/16W Metal Oxide
R1138	VRS-CY1JF000JY	AA		R	0 1/16W Metal Oxide
R1139	VRS-CJ1JF101JY	AA		R	100 1/16W Metal Oxide
R1140	VRS-CJ1JF331JY	AA		R	330 1/16W Metal Oxide
R1141	VRS-CY1JF564JY	AA		R	560k 1/16W Metal Oxide
R1142	VRS-CY1JF564JY	AA		R	560k 1/16W Metal Oxide
R1143	VRS-CJ1JF272JY	AA		R	2.7k 1/16W Metal Oxide
R1144	VRS-CY1JF102JY	AA		R	1k 1/16W Metal Oxide
R1145	VRS-CY1JF102JY	AA		R	1k 1/16W Metal Oxide
R1146	VRS-TV1JD221JY	AA		R	220 1/16W Metal Oxide
R1147	VRS-CY1JF102JY	AA		R	1k 1/16W Metal Oxide
R1148	VRS-TV1JD221JY	AA		R	220 1/16W Metal Oxide
R1150	VRS-CY1JF104JY	AA		R	100k 1/16W Metal Oxide
R1152	VRS-CJ1JF101JY	AA		R	100 1/16W Metal Oxide
R1153	VRS-CY1JF104JY	AA		R	100k 1/16W Metal Oxide
R1154	VRS-CY1JF104JY	AA		R	100k 1/16W Metal Oxide
R1155	VRS-CJ1JF331JY	AA		R	330 1/16W Metal Oxide

NO.	PARTS CODE	PRICE RANK	NEW MARK	PART DELIVERY	DESCRIPTION
[4] DUNTKD604FM11 (AV UNIT)					
R1156	VRS-CY1 JF 564 JY	AA		R	560k 1/16W Metal Oxide
R1157	VRS-CY1 JF 564 JY	AA		R	560k 1/16W Metal Oxide
R1158	VRS-CJ1 JF 272 JY	AA		R	2.7k 1/16W Metal Oxide
R1159	VRS-CY1 JF 102 JY	AA		R	1k 1/16W Metal Oxide
R1160	VRS-CY1 JF 102 JY	AA		R	1k 1/16W Metal Oxide
R1161	VRS-CY1 JF 221 JY	AA		R	220 1/16W Metal Oxide
R1173	VRS-CY1 JF 104 JY	AA		R	100k 1/16W Metal Oxide
R1177	VRS-CY1 JF 102 JY	AA		R	1k 1/16W Metal Oxide
R1179	VRS-CY1 JF 102 JY	AA		R	1k 1/16W Metal Oxide
R1201	VRS-CY1 JF 101 JY	AA		R	100 1/16W Metal Oxide
R1202	VRS-CY1 JF 392 JY	AA		R	3.9k 1/16W Metal Oxide
R1203	VRS-CY1 JF 682 JY	AA		R	6.8k 1/16W Metal Oxide
R1204	VRS-CY1 JF 750 JY	AA		R	75 1/16W Metal Oxide
R1206	VRS-TW2ED750 JY	AA		R	75 1/4W Metal Oxide
R1209	VRS-TW2ED750 JY	AA		R	75 1/4W Metal Oxide
R1210	VRS-CY1 JF 102 JY	AA		R	1k 1/16W Metal Oxide
R1211	VRS-CY1 JF 102 JY	AA		R	1k 1/16W Metal Oxide
R1212	VRS-CY1 JF 104 JY	AA		R	100k 1/16W Metal Oxide
R1213	VRS-CY1 JF 102 JY	AA		R	1k 1/16W Metal Oxide
R1214	VRS-CY1 JF 102 JY	AA		R	1k 1/16W Metal Oxide
R1215	VRS-CY1 JF 104 JY	AA		R	100k 1/16W Metal Oxide
R1216	VRS-CY1 JF 271 JY	AA		R	270 1/16W Metal Oxide
R1217	VRS-CY1 JF 331 JY	AA		R	330 1/16W Metal Oxide
R1218	VRS-CY1 JF 272 JY	AA		R	2.7k 1/16W Metal Oxide
R1219	VRS-CY1 JF 271 JY	AA		R	270 1/16W Metal Oxide
R1221	VRS-CY1 JF 331 JY	AA		R	330 1/16W Metal Oxide
R1222	VRS-CY1 JF 272 JY	AA		R	2.7k 1/16W Metal Oxide
R1224	VRS-CY1 JF 564 JY	AA		R	560k 1/16W Metal Oxide
R1225	VRS-CY1 JF 564 JY	AA		R	560k 1/16W Metal Oxide
R1226	VRS-CY1 JF 102 JY	AA		R	1k 1/16W Metal Oxide
R1227	VRS-CY1 JF 102 JY	AA		R	1k 1/16W Metal Oxide
R1228	VRS-CY1 JF 000 JY	AA		R	0 1/16W Metal Oxide
SC301	QSOCZ0738CEZZ	AE		R	Socket
[5] RDNCA204WJQZ (POWER Unit)					
C6	9JG0034007969	AD			Capacitor, 0.47 16V Chip Ceramic
C10	9JG0034006911	AA			Capacitor, 1000p 50V Chip Ceramic
C11	9JG0034017174	AB			Capacitor, 0.1 50V Chip Ceramic
C12	9JG0034002177	AB			Capacitor, 47000p 50V Chip Ceramic
C13	9JG0034038538				Capacitor, 1 16V Chip Ceramic
C22	9JG0034017174	AB			Capacitor, 0.1 50V Chip Ceramic
C23	9JG0034008019	AD			Capacitor, 0.22 50V Chip Ceramic
C24	9JG0034006865	AA			Capacitor, 100p 50V Chip Ceramic
C25	9JG0034017174	AB			Capacitor, 0.1 50V Chip Ceramic
C701	9JG0034012369	AG			Capacitor, 0.47 AC275V Film
C702	9JG0034029997				Capacitor, 0.33 AC275V Film
C703	9JG0034018278	AE			Capacitor, 0.1 AC275V Film
C704	9JG0034011540				Capacitor, 2200p AC250V Ceramic
C705	9JG0034011540				Capacitor, 2200p AC250V Ceramic
C706	9JG0034011540				Capacitor, 2200p AC250V Ceramic
C707	9JG0034011540				Capacitor, 2200p AC250V Ceramic
C710	9JG0034160996				Capacitor, 1 450V Film
C711	9JG0034017166	AB			Capacitor, 10000p 50V Chip Ceramic
C712	9JG0034006601	AG			Capacitor, 0.47 50V Film
C713	9JG0034017158	AA			Capacitor, 1000p 50V Chip Ceramic
C714	9JG0034017174	AB			Capacitor, 0.1 50V Chip Ceramic
C715	9JG0034017123	AC			Capacitor, 470p 50V Chip Ceramic
C716	9JG0034017158	AA			Capacitor, 1000p 50V Chip Ceramic
C717	9JG0034002177	AB			Capacitor, 47000p 50V Chip Ceramic
C718	9JG0034097356				Capacitor, 0.47 50V Chip Ceramic
C719	9JG0034017158	AA			Capacitor, 1000p 50V Chip Ceramic
C720	9JG0034002126	AB			Capacitor, 100p 50V Chip Ceramic
C721	9JG0034122164	AD			Capacitor, 10 6.3V Chip Ceramic
C722	9JG0034116962				Capacitor, 0.001 630V Film
C724	9JG0034019037	AG			Capacitor, 2200p 2kV Ceramic
C726	9JG0034094233	AV			Capacitor, 150 450V Electrolytic
C728	9JG0034094233	AV			Capacitor, 150 450V Electrolytic
C729	9JG0034006601	AG			Capacitor, 0.47 50V Film
C730	9JG0034017174	AB			Capacitor, 0.1 50V Chip Ceramic
C731	9JG0034058199	AC			Capacitor, 2.2 50V Electrolytic
C732	9JG0034033099	AD			Capacitor, 100p 1kV Ceramic
C733	9JG0034050694				Capacitor, 470p 2kV Ceramic
C734	9JG0034087121				Capacitor, 0.056 630V Film
C735	9JG0034033099	AD			Capacitor, 100p 1kV Ceramic
C736	9JG0034065829	AD			Capacitor, 220p AC250V Ceramic
C737	9JG0034065829	AD			Capacitor, 220p AC250V Ceramic
C739	9JG0034020310	AC			Capacitor, 2.2 10V Chip Ceramic
C741	9JG0034000204	AB			Capacitor, 0.1 50V Film
C742	9JG0034058199	AC			Capacitor, 2.2 50V Electrolytic
C743	9JG0034017166	AB			Capacitor, 10000p 50V Chip Ceramic
C745	9JG0034040370				Capacitor, 2.2 25V Chip Ceramic
C746	9JG0034017166	AB			Capacitor, 10000p 50V Chip Ceramic
C747	9JG0034007853	AC			Capacitor, 1 16V Chip Ceramic
C748	9JG0034021171	AC			Capacitor, 22 50V Electrolytic

△
△
△
△
△
△
△

△
△

NO.	PARTS CODE	PRICE RANK	NEW MARK	PART DELIVERY	DESCRIPTION
[5] RDNCA204WJQZ (POWER Unit)					
	C751	9JG0034001960			Capacitor, 220p 2kV Ceramic
	C752	9JG0034017093	AB		Capacitor, 220p 50V Chip Ceramic
	C753	9JG0034021236			Capacitor, 1 50V Electrolytic
	C754	9JG0034017174	AB		Capacitor, 0.1 50V Chip Ceramic
	C755	9JG0034017174	AB		Capacitor, 0.1 50V Chip Ceramic
	C756	9JG0034017085			Capacitor, 1500p 50V Chip Ceramic
	C757	9JG0034122008			Capacitor, 470p 50V Chip Ceramic
	C758	9JG0034021198	AC		Capacitor, 4.7 50V Electrolytic
	C759	9JG0034021244			Capacitor, 47 50V Electrolytic
	C760	9JG0034017174	AB		Capacitor, 0.1 50V Chip Ceramic
	C761	9JG0034021244			Capacitor, 47 50V Electrolytic
	C762	9JG0034087032			Capacitor, 0.01 630V Film
△	C763	9JG0034012261	AD		Capacitor, 470p AC250V Ceramic
△	C764	9JG0034012261	AD		Capacitor, 470p AC250V Ceramic
	C769	9JG0034117764			Capacitor, 0.0047 250V Film
	C770	9JG0034090114			Capacitor, 0.01 400V Film
	C771	9JG0034164231			Capacitor, 470 100V Electrolytic
	C772	9JG0034164231			Capacitor, 470 100V Electrolytic
	C773	9JG0034046239			Capacitor, 0.22 25V Chip Ceramic
	C782	9JG0034008434	AC		Capacitor, 1 25V Chip Ceramic
	C783	9JG0034017174	AB		Capacitor, 0.1 50V Chip Ceramic
	C785	9JG0034021201			Capacitor, 2200 10V Electrolytic
	C786	9JG0034021201			Capacitor, 2200 10V Electrolytic
	C787	9JG0034017174	AB		Capacitor, 0.1 50V Chip Ceramic
	C788	9JG0034017166	AB		Capacitor, 10000p 50V Chip Ceramic
	C790	9JG0034052840			Capacitor, 1000 25V Electrolytic
	C791	9JG0034052840			Capacitor, 1000 25V Electrolytic
	C792	9JG0034052840			Capacitor, 1000 25V Electrolytic
	C793	9JG0034086346			Capacitor, 470 50V Electrolytic
	C794	9JG0034086346			Capacitor, 470 50V Electrolytic
	C799	9JG0034021171	AC		Capacitor, 22 50V Electrolytic
	C800	9JG0034031819			Capacitor, 1000 10V Electrolytic
	C801	9JG0034017174	AB		Capacitor, 0.1 50V Chip Ceramic
	C802	9JG0034091811	AF		Capacitor, 470 25V Electrolytic
	C803	9JG0034091811	AF		Capacitor, 470 25V Electrolytic
	C804	9JG0034031940			Capacitor, 100 25V Electrolytic
	C805	9JG0034017166	AB		Capacitor, 10000p 50V Chip Ceramic
	C806	9JG0034017166	AB		Capacitor, 10000p 50V Chip Ceramic
	C807	9JG0034017166	AB		Capacitor, 10000p 50V Chip Ceramic
	C808	9JG0034017166	AB		Capacitor, 10000p 50V Chip Ceramic
	C811	9JG0034017166	AB		Capacitor, 10000p 50V Chip Ceramic
	C813	9JG0034021155			Capacitor, 470 25V Electrolytic
	C818	9JG0034091811	AF		Capacitor, 470 25V Electrolytic
	C819	9JG0034017174	AB		Capacitor, 0.1 50V Chip Ceramic
	C820	9JG0034017174	AB		Capacitor, 0.1 50V Chip Ceramic
	C821	9JG0034006059			Capacitor, 10 50V Electrolytic
	C822	9JG0034021198	AC		Capacitor, 4.7 50V Electrolytic
	D2	9JG0034038341	AE		Chip Diode, EC8FS6
△	D701	9JG0034017964	AE		Photocoupler, PS2571L1-1
△	D702	9JG0034017964	AE		Photocoupler, PS2571L1-1
△	D703	9JG0034017964	AE		Photocoupler, PS2571L1-1
△	D704	9JG0034017964	AE		Photocoupler, PS2571L1-1
△	D705	9JG0034017964	AE		Photocoupler, PS2571L1-1
△	D706	9JG0034017964	AE		Photocoupler, PS2571L1-1
△	D707	9JG0034017964	AE		Photocoupler, PS2571L1-1
△	D708	9JG0034017964	AE		Photocoupler, PS2571L1-1
△	D710	9JG0034016135	AM		Rectifier Stack, D5SBA60
	D711	9JG0034003289	AD		Diode, S5688J
	D712	9JG0034003289	AD		Diode, S5688J
	D713	9JG0034038392	AF		Diode, RM3A
	D714	9JG0034004668	AB		Diode, 1SS133
	D715	9JG0034039208	AK		Rectifier Stack, FMX-G26S
	D719	9JG0034004668	AB		Diode, 1SS133
	D720	9JG0034004668	AB		Diode, 1SS133
	D721	9JG0034007284	AC		Zener Diode, MTZJ18B
	D722	9JG0034008922			Zener Diode, MTZJ6.8
	D723	9JG0034004668	AB		Diode, 1SS133
	D724	9JG0034004056	AC		Chip Diode, DAN202K
	D725	9JG0034004668	AB		Diode, 1SS133
	D726	9JG0034004056	AC		Chip Diode, DAN202K
	D727	9JG0034008922			Zener Diode, MTZJ6.8
	D728	9JG0034004056	AC		Chip Diode, DAN202K
	D729	9JG0034004668	AB		Diode, 1SS133
	D730	9JG0034008922	AC		Zener Diode, MTZJ6.8
	D732	9JG0034078483			Zener Diode, MTZJ6.2
	D733	9JG0034004668	AB		Diode, 1SS133
	D734	9JG0034021902			Zener Diode, MTZJ10
	D735	9JG0034012377			Zener Diode, MTZJ22
	D736	9JG0034011974			Diode, 1SS244
	D737	9JG0034019363			Diode, 10ERB20
	D738	9JG0034011974			Diode, 1SS244
	D740	9JG0034009686			Diode, SARS02
	D741	9JG0034009686			Diode, SARS02
	D742	9JG0034007284	AC		Zener Diode, MTZJ18B

NO.	PARTS CODE	PRICE RANK	NEW MARK	PART DELIVERY	DESCRIPTION
[5] RDENCA204WJQZ (POWER Unit)					
D743	9JG0034004668	AB			Diode, 1SS133
D744	9JG0034004668	AB			Diode, 1SS133
D745	9JG0034004668	AB			Diode, 1SS133
D746	9JG0034004668	AB			Diode, 1SS133
D750	9JG0034168326				Rectifier Stack, FCH20A20
D752	9JG0034078483				Zener Diode, MTZJ6.2
D753	9JG0034004668	AB			Diode, 1SS133
D754	9JG0034006261				Zener Diode, MTZJ27
D755	9JG0034004897				Zener Diode, MTZJ20
D756	9JG0034011974				Diode, 1SS244
D757	9JG0034067198				Rectifier Stack, FCH20A10
D758	9JG0034003580				Rectifier Stack, FMX-G12S
D759	9JG0034083398				Diode, EU02
D760	9JG0034002967	AD			Chip Diode, 1SS226
D761	9JG0034030863				Zener Diode, MTZJ10.0
D762	9JG0034007284	AC			Zener Diode, MTZJ18B
D763	9JG0034007284	AC			Zener Diode, MTZJ18B
D764	9JG0034029970				Zener Diode, MTZJ8.2
D766	9JG0034004668	AB			Diode, 1SS133
D767	9JG0034004668	AB			Diode, 1SS133
D768	9JG0034021902	AC			Zener Diode, MTZJ10
D771	9JG0034013314				Zener Diode, MTZJ12
D772	9JG0034004668	AB			Diode, 1SS133
D773	9JG0034007276				Zener Diode, MTZJ36
D774	9JG0034007276				Zener Diode, MTZJ36
D775	9JG0034004668	AB			Diode, 1SS133
D776	9JG0034009856				Zener Diode, MTZJ15
D777	9JG0034004668	AB			Diode, 1SS133
D778	9JG0034004889	AC			Zener Diode, MTZJ5.6
D779	9JG0034004668	AB			Diode, 1SS133
D780	9JG0034004919				Zener Diode, MTZJ2.7
D781	9JG0034004668	AB			Diode, 1SS133
D782	9JG0034006105				Zener Diode, MTZJ5.1
D783	9JG0034078483				Zener Diode, MTZJ6.2
D784	9JG0034148422				Zener Diode, MTZJ3.9
D785	9JG0034004919				Zener Diode, MTZJ2.7
D786	9JG0034004668	AB			Diode, 1SS133
D787	9JG0034004668	AB			Diode, 1SS133
D788	9JG0034006261				Zener Diode, MTZJ27
D789	9JG0034004897				Zener Diode, MTZJ20
D790	9JG0034004919				Zener Diode, MTZJ2.7
D791	9JG0034004668	AB			Diode, 1SS133
D792	9JG0034004056	AC			Chip Diode, DAN202K
D794	9JG0034016607	AG			Rectifier Stack, FMB-G14L
D798	9JG0034004919				Zener Diode, MTZJ2.7
D799	9JG0034004056	AC			Chip Diode, DAN202K
D800	9JG0034004056	AC			Chip Diode, DAN202K
D801	9JG0034011974				Diode, 1SS244
D802	9JG0034064350				Zener Diode, MTZJ4.7
D803	9JG0034004056	AC			Chip Diode, DAN202K
D804	9JG0034073511				Chip Diode, SFPM-52
D805	9JG0034004056	AC			Chip Diode, DAN202K
D806	9JG0034036888				Chip Diode, SFPX-63
D807	9JG0034064946				Diode, AG01Z
D808	9JG0034004897				Zener Diode, MTZJ20
D809	9JG0034004897				Zener Diode, MTZJ20
△ F701	9JG0034088292				Ceramic Fuse, AC250V 6.3A
FB701	9JG0034018456				Ferrite Bead, BL02RN1
FB702	9JG0034027765				Ferrite Bead, G5BT 3X2X1
FB703	9JG0034027765				Ferrite Bead, G5BT 3X2X1
FB704	9JG0034027765				Ferrite Bead, G5BT 3X2X1
FB705	9JG0034027765				Ferrite Bead, G5BT 3X2X1
IC701	9JG0034037760	AL			IC, MC33262D
IC702	9JG0034050953				IC, STR-W6765
IC703	9JG0034020736	AG			IC, AN1431T
IC704	9JG0034020736	AG			IC, AN1431T
IC705	9JG0034050279				IC, SI-3010KF
IC708	9JG0034159041				IC, SI-8008HFE
IC709	9JG0034020736	AG			IC, AN1431T
IC710	9JG0034067929				IC, EpPC393G2
△ L701	9JG0034129630				Reactor, DRB25-03A-133NP
△ L702	9JG0034129630				Reactor, DRB25-03A-133NP
△ L703	9JG0034110999				Reactor, HK-10S080-1210
△ L704	9JG0037172111				Reactor, EXZ40790-204
L705	9JG0034027358	AE			Reactor, 270mA22E _b H
L706	9JG0034027358	AE			Reactor, 270mA22E _b H
L708	9JG0030600150				Reactor, CX40357-005
L709	9JG0034063702				Reactor, HK-10S100-4500
L710	9JG0030600150				Reactor, CX40357-005
Q701	9JG0034008523	AC			Chip Transistor, DTA143EKA
Q702	9JG0034003351	AE			Transistor, 2SC2655
Q703	9JG0034000697	AE			Transistor, 2SA1020
△ Q704	9JG0034095167	AP			FET, RDX100N60
△ Q705	9JG0034095167	AP			FET, RDX100N60
Q706	9JG0034008523	AC			Chip Transistor, DTA143EKA

NO.	PARTS CODE	PRICE RANK	NEW MARK	PART DELIVERY	DESCRIPTION
[5] RDECA204WJQZ (POWER Unit)					
△	Q707	9JG0034075387			FET, 2SK3687
△	Q708	9JG0034075387			FET, 2SK3687
	Q709	9JG0034008523	AC		Chip Transistor, DTA143EKA
△	Q710	9JG0034027978	AE		FET, 2SK2731
	Q711	9JG0034004072	AC		Chip Transistor, 2SC2412K
	Q712	9JG0034004072	AC		Chip Transistor, 2SC2412K
	Q713	9JG0034027978	AE		FET, 2SK2731
	Q714	9JG0034027455	AC		Chip Transistor, 2SA1037AK
	Q715	9JG0034004072	AC		Chip Transistor, 2SC2412K
	Q716	9JG0034008523	AC		Chip Transistor, DTA143EKA
	Q717	9JG0034004072	AC		Chip Transistor, 2SC2412K
	Q718	9JG0034031703			Transistor, 2SC3852A
	Q721	9JG0034000239			Transistor, 2SC1815
	Q722	9JG0034004072	AC		Chip Transistor, 2SC2412K
△	Q726	9JG0034095337			FET, 2SK2421
	Q727	9JG0034003351	AE		Transistor, 2SC2655
△	Q728	9JG0034004072	AC		Chip Transistor, 2SC2412K
	Q729	9JG0034065152	AC		Chip Transistor, DTC114EKA
	Q731	9JG0034050309			FET, 2SK3659
	Q732	9JG0034065152	AC		Chip Transistor, DTC114EKA
	Q733	9JG0034004072	AC		Chip Transistor, 2SC2412K
	Q734	9JG0034004072	AC		Chip Transistor, 2SC2412K
	Q735	9JG0034004072	AC		Chip Transistor, 2SC2412K
	Q736	9JG0034008523	AC		Chip Transistor, DTA143EKA
	Q737	9JG0034004072	AC		Chip Transistor, 2SC2412K
	Q738	9JG0034004072	AC		Chip Transistor, 2SC2412K
	Q739	9JG0034004072	AC		Chip Transistor, 2SC2412K
	Q740	9JG0034004072	AC		Chip Transistor, 2SC2412K
	Q741	9JG0034004072	AC		Chip Transistor, 2SC2412K
	Q742	9JG0034004072	AC		Chip Transistor, 2SC2412K
	Q745	9JG0034004072	AC		Chip Transistor, 2SC2412K
	Q746	9JG0034065152	AC		Chip Transistor, DTC114EKA
	Q747	9JG0034004072	AC		Chip Transistor, 2SC2412K
	Q750	9JG0034027978	AE		FET, 2SK2731
	Q751	9JG0034009139			FET, 2SK2865
	Q752	9JG0034004072	AC		Chip Transistor, 2SC2412K
	Q753	9JG0034004072	AC		Chip Transistor, 2SC2412K
	R7	9JG0034051852			Chip Resistor, 4.7 1/8W
	R9	9JG0034025401			Chip Resistor, 100 1/10W
	R13	9JG0034048401			Chip Resistor, 2.2k 1/10W
	R15	9JG0034025630			Chip Resistor, 22k 1/10W
△	R702	9JG0034066817	AF		Resistor, 3.9M 1W Special Power
△	R703	9JG0034066817	AF		Resistor, 3.9M 1W Special Power
	R704	9JG0034005273	AA		Chip Resistor, 1k 1/8W
	R705	9JG0034015139	AB		Resistor, 470k 1/2W Special Power
	R706	9JG0034015139	AB		Resistor, 470k 1/2W Special Power
	R707	9JG0034016259	AA		Chip Resistor, 100k 1/10W
	R708	9JG0034001472			Resistor, 470k 1/4W Carbon
	R709	9JG0034001472			Resistor, 470k 1/4W Carbon
	R710	9JG0034067430			Resistor, 330k 1/4W Carbon
	R711	9JG0034003882	AA		Chip Resistor, 15k 1/10W
	R712	9JG0034003955	AA		Chip Resistor, 4.7k 1/10W
	R713	9JG0034001359			Resistor, 470 1/4W Carbon
	R714	9JG0034003874	AA		Chip Resistor, 22k 1/10W
	R715	9JG0034003874	AA		Chip Resistor, 22k 1/10W
	R716	9JG0034004331	AA		Chip Resistor, 5.6k 1/8W
	R717	9JG0034003866	AA		Chip Resistor, 6.8k 1/10W
	R718	9JG0034016240	AA		Chip Resistor, 10k 1/10W
	R719	9JG0034003742	AA		Chip Resistor, 100 1/10W
	R721	9JG0034033900	AB		Resistor, 1 1/2W Metal Oxide
	R723	9JG0034014957			Resistor, 22 1W Metal Oxide
	R724	9JG0034014957			Resistor, 22 1W Metal Oxide
	R725	9JG0034016259	AA		Chip Resistor, 100k 1/10W
	R726	9JG0034066906	AE		Resistor, 0.1 3W Metal Oxide
	R727	9JG0034152713			Resistor, 820k 1/2W Special Power
	R728	9JG0034152713			Resistor, 820k 1/2W Special Power
	R729	9JG0034004145			Chip Resistor, 8.2k 1/10W
	R730	9JG0034005974	AA		Chip Resistor, 10k 1/10W
	R731	9JG0034016372			Chip Resistor, 270 1/10W
	R732	9JG0034028141	AB		Resistor, 680K 1/2W Special Power
	R733	9JG0034161798			Resistor, 560K 1/2W Special Power
	R734	9JG0034165041			Resistor, 390k 1/2W Special Power
	R735	9JG0034016259	AA		Chip Resistor, 100k 1/10W
	R737	9JG0034016283	AA		Chip Resistor, 220 1/10W
	R738	9JG0034063788			Chip Resistor, 39 1/10W
	R740	9JG0034001898	AB		Resistor, 0.22 1/2W Metal Oxide
	R741	9JG0034016259	AA		Chip Resistor, 100k 1/10W
	R742	9JG0034019061			Resistor, 4.7 1/2W Metal Oxide
	R743	9JG0034003653	AB		Resistor, 10 1/2W Metal Oxide
	R744	9JG0034016259	AA		Chip Resistor, 100k 1/10W
	R751	9JG0034001405			Resistor, 4.7k 1/4W Carbon
	R752	9JG0034016259	AA		Chip Resistor, 100k 1/10W
	R753	9JG0034001421	AD		Resistor, 10k 1/4W Carbon
	R754	9JG0034016291	AA		Chip Resistor, 2.2k 1/10W
	R755	9JG0034004595	AA		Chip Resistor, 56k 1/10W

NO.	PARTS CODE	PRICE RANK	NEW MARK	PART DELIVERY	DESCRIPTION
[5] RDENCA204WJQZ (POWER Unit)					
R756	9JG0034003920	AA			Chip Resistor, 0 1/10W
R757	9JG0034003955	AA			Chip Resistor, 4.7k 1/10W
R758	9JG0034004595	AA			Chip Resistor, 56k 1/10W
R759	9JG0034005176	AA			Chip Resistor, 470k 1/10W
R760	9JG0034016259	AA			Chip Resistor, 100k 1/10W
R761	9JG0034001421	AD			Resistor, 10k 1/4W Carbon
R762	9JG0034001464				Resistor, 100k 1/4W Carbon
R763	9JG0034004005	AA			Chip Resistor, 27k 1/10W
R764	9JG0034005931				Chip Resistor, 12k 1/10W
R765	9JG0034016240	AA			Chip Resistor, 10k 1/10W
R766	9JG0034016240	AA			Chip Resistor, 10k 1/10W
R767	9JG0034016240	AA			Chip Resistor, 10k 1/10W
R768	9JG0034016240	AA			Chip Resistor, 10k 1/10W
R769	9JG0034016240	AA			Chip Resistor, 10k 1/10W
R770	9JG0034003742	AA			Chip Resistor, 100 1/10W
R771	9JG0034016240	AA			Chip Resistor, 10k 1/10W
R772	9JG0034003955	AA			Chip Resistor, 4.7k 1/10W
R773	9JG0034003920	AA			Chip Resistor, 0 1/10W
R774	9JG0034004013				Chip Resistor, 390 1/10W
R775	9JG0034005230	AA			Chip Resistor, 22 1/8W
R776	9JG0034001421	AD			Resistor, 10k 1/4W Carbon
R777	9JG0034017816				Chip Resistor, 22k 1/10W
R778	9JG0034073473				Chip Resistor, 1.5k 1/10W
R779	9JG0034003750	AA			Chip Resistor, 1k 1/10W
R780	9JG0034033900	AB			Resistor, 1 1/2W Metal Oxide
R781	9JG0034031185				Resistor, 0.33 2W Metal Oxide
R782	9JG0034003742	AA			Chip Resistor, 100 1/10W
R783	9JG0034004390	AB			Resistor, 2.2 1/2W Metal Oxide
R784	9JG0034016313	AA			Chip Resistor, 2.7k 1/10W
R785	9JG0034016240	AA			Chip Resistor, 10k 1/10W
R786	9JG0034003955	AA			Chip Resistor, 4.7k 1/10W
R787	9JG0034033897				Resistor, 1k 1/2W Metal Oxide
R788	9JG0034003874	AA			Chip Resistor, 22k 1/10W
R789	9JG0034003653	AB			Resistor, 10 1/2W Metal Oxide
R790	9JG0034053065				Resistor, 0.22 1W Metal Oxide
R791	9JG0034015139	AB			Resistor, 470k 1/2W Special Power
R792	9JG0034083797				Resistor, 22 3W Metal Oxide
R793	9JG0034019258				Resistor, 150K 1/2W Special Power
R794	9JG0034019258				Resistor, 150K 1/2W Special Power
R795	9JG0034023832				Resistor, 56k 1/2W Metal Oxide
R796	9JG0034023832				Resistor, 56k 1/2W Metal Oxide
R797	9JG0034023832				Resistor, 56k 1/2W Metal Oxide
R798	9JG0034003750	AA			Chip Resistor, 1k 1/10W
R799	9JG0034003599	AB			Resistor, 100 1/2W Metal Oxide
R800	9JG0034003866	AA			Chip Resistor, 6.8k 1/10W
R801	9JG0034016291	AA			Chip Resistor, 2.2k 1/10W
R802	9JG0034003750	AA			Chip Resistor, 1k 1/10W
R803	9JG0034016240	AA			Chip Resistor, 10k 1/10W
R804	9JG0034036586				Resistor, 10k 1W Metal Oxide
R805	9JG0034003920	AA			Chip Resistor, 0 1/10W
R806	9JG0034018162	AA			Chip Resistor, 1.5k 1/10W
R807	9JG0034018162	AA			Chip Resistor, 1.5k 1/10W
R808	9JG0034016240	AA			Chip Resistor, 10k 1/10W
R809	9JG0034016291	AA			Chip Resistor, 2.2k 1/10W
R811	9JG0034003750	AA			Chip Resistor, 1k 1/10W
R812	9JG0034001391				Resistor, 2.2k 1/4W Carbon
R813	9JG0034003750	AA			Chip Resistor, 1k 1/10W
R815	9JG0034016380				Chip Resistor, 390 1/10W
R816	9JG0034005966				Chip Resistor, 8.2k 1/10W
R817	9JG0034016364	AA			Chip Resistor, 2.2k 1/10W
R824	9JG0034023883				Resistor, 22k 1/4W Carbon
R825	9JG0034001421	AD			Resistor, 10k 1/4W Carbon
R826	9JG0034030448	AA			Chip Resistor, 1.2k 1/10W
R827	9JG0034005966				Chip Resistor, 8.2k 1/10W
R828	9JG0034007349	AA			Chip Resistor, 1k 1/10W
R829	9JG0034003955	AA			Chip Resistor, 4.7k 1/10W
R830	9JG0034004226	AB			Resistor, 22 1/2W Metal Oxide
R831	9JG0034001383				Resistor, 1k 1/4W Carbon
R832	9JG0034024154	AA			Chip Resistor, 820 1/10W
R833	9JG0034005966				Chip Resistor, 8.2k 1/10W
R834	9JG0034007349	AA			Chip Resistor, 1k 1/10W
R842	9JG0034016240	AA			Chip Resistor, 10k 1/10W
R843	9JG0034004315	AA			Chip Resistor, 2.2k 1/8W
R844	9JG0034016259	AA			Chip Resistor, 100k 1/10W
R845	9JG0034003742	AA			Chip Resistor, 100 1/10W
R846	9JG0034004293	AA			Chip Resistor, 100 1/8W
R847	9JG0034004293	AA			Chip Resistor, 100 1/8W
R848	9JG0034004293	AA			Chip Resistor, 100 1/8W
R849	9JG0034004293	AA			Chip Resistor, 100 1/8W
R850	9JG0034016291	AA			Chip Resistor, 2.2k 1/10W
R851	9JG0034003750	AA			Chip Resistor, 1k 1/10W
R852	9JG0034005257	AA			Chip Resistor, 470 1/8W
R853	9JG0034003750	AA			Chip Resistor, 1k 1/10W
R854	9JG0034016291	AA			Chip Resistor, 2.2k 1/10W
R855	9JG0034003742	AA			Chip Resistor, 100 1/10W

NO.	PARTS CODE	PRICE RANK	NEW MARK	PART DELIVERY	DESCRIPTION
[5] RDNCA204WJQZ (POWER Unit)					
	R856	9JG0034016291	AA		Chip Resistor, 2.2k 1/10W
	R857	9JG0034016240	AA		Chip Resistor, 10k 1/10W
	R858	9JG0034016291	AA		Chip Resistor, 2.2k 1/10W
	R859	9JG0034016291	AA		Chip Resistor, 2.2k 1/10W
	R860	9JG0034003742	AA		Chip Resistor, 100 1/10W
	R861	9JG0034016291	AA		Chip Resistor, 2.2k 1/10W
	R862	9JG0034016240	AA		Chip Resistor, 10k 1/10W
	R863	9JG0034016291	AA		Chip Resistor, 2.2k 1/10W
	R864	9JG0034016321	AA		Chip Resistor, 47k 1/10W
	R865	9JG0034003920	AA		Chip Resistor, 0 1/10W
	R866	9JG0034016321	AA		Chip Resistor, 47k 1/10W
	R867	9JG0034003955	AA		Chip Resistor, 4.7k 1/10W
	R868	9JG0034003955	AA		Chip Resistor, 4.7k 1/10W
	R869	9JG0034016291	AA		Chip Resistor, 2.2k 1/10W
	R870	9JG0034016291	AA		Chip Resistor, 2.2k 1/10W
	R871	9JG0034003955	AA		Chip Resistor, 4.7k 1/10W
	R872	9JG0034016291	AA		Chip Resistor, 2.2k 1/10W
	R873	9JG0034003955	AA		Chip Resistor, 4.7k 1/10W
	R874	9JG0034001391			Resistor, 2.2k 1/4W Carbon
	R875	9JG0034003955	AA		Chip Resistor, 4.7k 1/10W
	R876	9JG0034016291	AA		Chip Resistor, 2.2k 1/10W
	R883	9JG0034016240	AA		Chip Resistor, 10k 1/10W
	R884	9JG0034004021	AA		Chip Resistor, 470 1/10W
	R885	9JG0034003971			Chip Resistor, 150 1/10W
	R886	9JG0034016291	AA		Chip Resistor, 2.2k 1/10W
	R887	9JG0034053901			Chip Resistor, 560 1/10W
	R888	9JG0034006768	AA		Chip Resistor, 3.9k 1/10W
	R889	9JG0034024154	AA		Chip Resistor, 820 1/10W
	R890	9JG0034016240	AA		Chip Resistor, 10k 1/10W
	R893	9JG0034003750	AA		Chip Resistor, 1k 1/10W
	R894	9JG0034001383			Resistor, 1k 1/4W Carbon
	R895	9JG0034016240	AA		Chip Resistor, 10k 1/10W
	R896	9JG0034003750	AA		Chip Resistor, 1k 1/10W
	R897	9JG0034022526			Resistor, 47k 1/4W Carbon
	R898	9JG0034003904	AA		Chip Resistor, 10k 1/8W
	R899	9JG0034016259	AA		Chip Resistor, 100k 1/10W
	R900	9JG0034003793			Chip Resistor, 33k 1/10W
	R901	9JG0034003793			Chip Resistor, 33k 1/10W
	R902	9JG0034016321	AA		Chip Resistor, 47k 1/10W
	R903	9JG0034003688	AA		Chip Resistor, 3.3k 1/10W
	RL701	9JG0034160953			Relay, SDT-S-118DMR
△	T701	9JG0037172103			Transformer, EXT45841-407
△	T702	9JG0037172081			Transformer, EXT41641-408
	TH701	9JG0034022038			Thermistor, SCK15086M
△	VA701	9JG0034054207	AF		Surge Absorber, ERZV10D471
△	VA702	9JG0034054207	AF		Surge Absorber, ERZV10D471
	Z1	9JG0034037736	AS		IC, SPF9001
	LA	9JG0034062420			Connector, B6P-VH
	PA	9JG0034132844			Connector, TWG-P23P-A1
	PB	9JG0034028508			Connector, TWG-P9P-A1
	PC	9JG0034075476			Connector, TWG-P7P-A1
	PL	9JG0034094713	AG		Connector, B04B-PASK-1
△	SC701	9JG0034078424	AL		Receptacle, CCT2302-0711
	TK701	9JG0034139466			Sheet Metal Fitting
	TK702	9JG0034139466			Sheet Metal Fitting
	TK703	9JG0034139466			Sheet Metal Fitting
	TK704	9JG0034139466			Sheet Metal Fitting
	TK705	9JG0034139466			Sheet Metal Fitting
	1	9JG0034098026	AG		Sheet Metal Fitting
	2	9JG0034015775			Sheet Metal Fitting x2
	4	9JG0034168601			Heat Sink
	5	9JG0034161372			Heat Sink x2
△	6	9JG0034164983			Heat Sink x2
△	7	9JG0034164991			Heat Sink
△	9	9JG0034017611	AA		Screw x11
△	10	9JG0034031983			Screw x4
△	11	9JG0034114846			Name Plate
△	1	9JG0034114838			Sheet Metal Fitting
△	2	9JG0034114773			Sheet Metal Fitting
	PN1	9JG0034007837			Lead Frame x14
[6] DUNTKD833FM02 (D-TUNER Unit)					
	C202	VCCCCY1HH220JY	AA	R	22p 50V Ceramic
	C203	VCCCCY1HH220JY	AA	R	22p 50V Ceramic
	C204	VCEASX0JN108MY	AE	R	1000 6.3V Electrolytic
	C205	VCKYCY1HF103ZY	AA	R	0.01 50V Ceramic
	C206	VCEASX1CN107MY	AC	R	100 16V Electrolytic
	C207	VCKYCY1HF103ZY	AA	R	0.01 50V Ceramic
	C208	VCKYCY1EF104ZY	AA	R	0.1 25V Ceramic
	C209	VCKYCY1HB102KY	AA	R	1000p 50V Ceramic
	C211	VCKYCY1HF103ZY	AA	R	0.01 50V Ceramic
	C212	VCEASX1HN106MY	AC	R	10 50V Electrolytic
	C222	VCKYCY1HF103ZY	AA	R	0.01 50V Ceramic
	C227	VCKYCY1HF103ZY	AA	R	0.01 50V Ceramic

NO.	PARTS CODE	PRICE RANK	NEW MARK	PART DELIVERY	DESCRIPTION
[6] DUNTKD833FM02 (D-TUNER Unit)					
C230	VCEASX1HN106MY	AC		R	10 50V Electrolytic
C233	VCKYCY1HB102KY	AA		R	1000p 50V Ceramic
C235	VCCCCY1HH150JY	AA		R	15p 50V Ceramic
C236	VCKYCY1HF103ZY	AA		R	0.01 50V Ceramic
C237	VCEASX1HN225MY	AB		R	2.2 50V Electrolytic
C241	VCEASX1AN336MY	AC		R	33 10V Electrolytic
C242	VCEASX1CN106MY	AC		R	10 16V Electrolytic
C243	VCKYCY1EF104ZY	AA		R	0.1 25V Ceramic
C244	VCEASX0JN226MY	AB		R	22 6.3V Electrolytic
C245	VCKYCY1EF104ZY	AA		R	0.1 25V Ceramic
C246	VCEASX1CN106MY	AC		R	10 16V Electrolytic
C247	VCEASX1CN106MY	AC		R	10 16V Electrolytic
C248	VCKYCY1HF103ZY	AA		R	0.01 50V Ceramic
C249	VCEASX1CN106MY	AC		R	10 16V Electrolytic
C250	VCKYCY1HF103ZY	AA		R	0.01 50V Ceramic
C251	VCKYCY1HF103ZY	AA		R	0.01 50V Ceramic
C252	VCEASX1CN106MY	AC		R	10 16V Electrolytic
C253	VCKYCY1HF103ZY	AA		R	0.01 50V Ceramic
C254	VCKYCY1HF103ZY	AA		R	0.01 50V Ceramic
C256	VCKYCY1EF104ZY	AA		R	0.1 25V Ceramic
C257	VCKYCY1HB103KY	AA		R	0.01 50V Ceramic
C258	VCKYCY1HB103KY	AA		R	0.01 50V Ceramic
C259	VCCCCY1HH2R0CY	AA		R	20p 50V Ceramic
C260	VCCCCY1HH150JY	AA		R	15p 50V Ceramic
C261	VCEASX1CN106MY	AC		R	10 16V Electrolytic
C262	VCKYCY1EF104ZY	AA		R	0.1 25V Ceramic
C263	VCKYCY1EF104ZY	AA		R	0.1 25V Ceramic
C266	VCKYCY1HF103ZY	AA		R	0.01 50V Ceramic
C267	VCKYCY1HF103ZY	AA		R	0.01 50V Ceramic
C268	VCKYCY1EB104KY	AB		R	0.1 25V Ceramic
C269	VCKYCY1EB104KY	AB		R	0.1 25V Ceramic
C270	VCAAPD0JJ227MY	AF		R	220 6.3V Electrolytic
C271	VCKYCY1HF103ZY	AA		R	0.01 50V Ceramic
C272	VCKYCY1HB102KY	AA		R	1000p 50V Ceramic
C273	VCAAPD0JJ227MY	AF		R	220 6.3V Electrolytic
C279	RC-KZA073WJZZY	AD		R	Capacitor
D202	RH-EXA102WJZZY	AB		R	UDZSTE-1733B
FB201	RBLN-0210TAZZY	AB		R	Balun
FB202	RBLN-0065CEZZY	AC		R	Balun
FB203	RBLN-0060TAZZY	AB		R	Balun
IC201	VHIT7WB125A-1Y	AE		R	TC7WBD125AFK(T5L,F)
IC202	RH-iXB682WJZZQ	AZ		R	STV0360C
IC204	VHILV4053FT-1Y			R	TC74LVX4053FT(EL)
IC205	VHIPQ1M185M-1Y	AD		R	PQ1M185M2SPQ
IC206	VHIMM3033E+-1Y	AD		R	MM3033EURE
L206	VPCUN1R5MR12NY	AC		R	Peaking 1.5uH
L207	VPCNN2R2JR77NY	AB		R	Peaking 2.2uH
L208	VPCNN2R2JR77NY	AB		R	Peaking 2.2uH
L209	VPCNN2R2JR77NY	AB		R	Peaking 2.2uH
L210	VPCNN2R2JR77NY	AB		R	Peaking 2.2uH
L213	VPCKM330J3R9NY	AB		R	Peaking 33uH
LUG201	QLUGHA009WJZZY	AC		R	Lug
LUG202	QLUGHA009WJZZY	AC		R	Lug
LUG203	QLUGHA009WJZZY	AC		R	Lug
P201	QCNCMA012WJZZ	AD		R	Connector
P202	QCNCMA250WJZZ	AE		R	Connector
Q203	VS2SC2735//1EY	AC		R	2SC2735JC21TL
Q209	VSRN4904//--1Y	AB		R	RN4904(TE85L,F)
Q210	VS2SC2735//1EY	AC		R	2SC2735JC21TL
R201	VRS-CY1JF000JY	AA		R	0 1/16W Metal Oxide
R205	VRS-CY1JF750JY	AA		R	75 1/16W Metal Oxide
R207	VRS-CY1JF470JY	AA		R	47 1/16W Metal Oxide
R208	VRS-CY1JF470JY	AA		R	47 1/16W Metal Oxide
R209	VRS-CY1JF000JY	AA		R	0 1/16W Metal Oxide
R211	VRS-CY1JF000JY	AA		R	0 1/16W Metal Oxide
R213	VRS-CY1JF000JY	AA		R	0 1/16W Metal Oxide
R214	VRS-CY1JF100JY	AA		R	10 1/16W Metal Oxide
R215	VRS-CY1JF472JY	AA		R	4.7k 1/16W Metal Oxide
R216	VRS-CY1JF472JY	AA		R	4.7k 1/16W Metal Oxide
R217	VRS-CY1JF472JY	AA		R	4.7k 1/16W Metal Oxide
R218	VRS-CY1JF472JY	AA		R	4.7k 1/16W Metal Oxide
R220	VRS-CY1JF101JY	AA		R	100 1/16W Metal Oxide
R225	VRS-TW2ED561JY	AA		R	560 1/4W Metal Oxide
R226	VRS-CY1JF273JY	AA		R	27k 1/16W Metal Oxide
R227	VRS-CY1JF000JY	AA		R	0 1/16W Metal Oxide
R228	VRS-TQ2BD1R0JY	AA		R	1 1/8W Metal Oxide
R237	VRS-CY1JF331JY	AA		R	330 1/16W Metal Oxide
R238	VRS-CY1JF151JY	AA		R	150 1/16W Metal Oxide
R241	VRS-CY1JF103JY	AA		R	10k 1/16W Metal Oxide
R242	VRS-CY1JF392JY	AA		R	3.9k 1/16W Metal Oxide
R243	VRS-CY1JF101JY	AA		R	100 1/16W Metal Oxide
R245	VRS-CH1JF103JY	AA		R	10k 1/16W Metal Oxide
R247	VRS-CY1JF000JY	AA		R	0 1/16W Metal Oxide
R248	VRS-CY1JF153JY	AA		R	15k 1/16W Metal Oxide
R255	VRS-CY1JF470JY	AA		R	47 1/16W Metal Oxide

NO.	PARTS CODE	PRICE RANK	NEW MARK	PART DELIVERY	DESCRIPTION
[6] DUNTKD833FM02 (D-TUNER Unit)					
R256	VRS-CY1JF470JY	AA		R	47 1/16W Metal Oxide
R259	VRS-CY1JF151JY	AA		R	150 1/16W Metal Oxide
R264	VRS-CY1JF101JY	AA		R	100 1/16W Metal Oxide
R265	VRS-CY1JF101JY	AA		R	100 1/16W Metal Oxide
R266	VRS-CY1JF000JY	AA		R	0 1/16W Metal Oxide
R267	VRS-CY1JF000JY	AA		R	0 1/16W Metal Oxide
R268	VRS-CY1JF000JY	AA		R	0 1/16W Metal Oxide
R269	VRS-CY1JF000JY	AA		R	0 1/16W Metal Oxide
R270	VRS-CY1JF514JY	AA		R	510k 1/16W Metal Oxide
R271	VRS-CY1JF102JY	AA		R	1k 1/16W Metal Oxide
R272	VRS-CH1JF000JY	AA		R	0 1/16W Metal Oxide
R273	VRS-CH1JF000JY	AA		R	0 1/16W Metal Oxide
R274	VRS-CY1JF000JY	AA		R	0 1/16W Metal Oxide
R275	VRS-TW2HF1R8JY	AA		R	1.8 1/2W Metal Oxide
R276	VRS-TW2HF1R8JY	AA		R	1.8 1/2W Metal Oxide
R277	VRS-TW2HF1R8JY	AA		R	1.8 1/2W Metal Oxide
R281	VRS-CY1JF000JY	AA		R	0 1/16W Metal Oxide
R282	VRS-CY1JF000JY	AA		R	0 1/16W Metal Oxide
R283	VRS-CY1JF000JY	AA		R	0 1/16W Metal Oxide
R284	VRS-CY1JF103JY	AA		R	10k 1/16W Metal Oxide
R285	VRS-CY1JF103JY	AA		R	10k 1/16W Metal Oxide
R286	VRS-CY1JF100JY	AA		R	10 1/16W Metal Oxide
R287	VRS-CY1JF272JY	AA		R	2.7k 1/16W Metal Oxide
R289	VRS-CY1JF103JY	AA		R	10k 1/16W Metal Oxide
R290	VRS-CY1JF181JY	AA		R	180 1/16W Metal Oxide
R293	VRS-CY1JF000JY	AA		R	0 1/16W Metal Oxide
R294	VRS-CY1JF000JY	AA		R	0 1/16W Metal Oxide
TU201	RTUNQA034WJZZ			R	Tuner
X202	RCRSCA039WJZZY	AG		R	Crystal
[7] DIGITAL Unit (DUNTKD833FM02)					
C4001	VCEASX1HN105MY	AB		R	1 50V Electrolytic
C4002	VCKYCY1HB103KY	AA		R	0.01 50V Ceramic
C4003	VCKYCY1EF104ZY	AA		R	0.1 25V Ceramic
C4004	VCKYCY1EF104ZY	AA		R	0.1 25V Ceramic
C4005	VCKYCY1HB103KY	AA		R	0.01 50V Ceramic
C4006	VCCCCY1HH180JY	AA		R	18p 50V Ceramic
C4007	VCCCCY1HH150JY	AA		R	15p 50V Ceramic
C4008	VCEASX1CN106MY	AC		R	10 16V Electrolytic
C4009	VCKYCY1HB103KY	AA		R	0.01 50V Ceramic
C4010	VCKYCY1EF104ZY	AA		R	0.1 25V Ceramic
C4011	VCKYCY1EF104ZY	AA		R	0.1 25V Ceramic
C4012	VCKYCY1EF104ZY	AA		R	0.1 25V Ceramic
C4013	VCKYCY1HB103KY	AA		R	0.01 50V Ceramic
C4014	VCKYCY1EF104ZY	AA		R	0.1 25V Ceramic
C4015	VCKYCY1EF104ZY	AA		R	0.1 25V Ceramic
C4016	VCKYCY1HB103KY	AA		R	0.01 50V Ceramic
C4017	VCKYCY1EF104ZY	AA		R	0.1 25V Ceramic
C4018	VCKYCY1EF104ZY	AA		R	0.1 25V Ceramic
C4019	VCEASX1CN106MY	AC		R	10 16V Electrolytic
C4020	VCKYCY1EF104ZY	AA		R	0.1 25V Ceramic
C4021	VCKYCY1EF104ZY	AA		R	0.1 25V Ceramic
C4022	VCKYCY1EF104ZY	AA		R	0.1 25V Ceramic
C4023	VCKYCY1EF104ZY	AA		R	0.1 25V Ceramic
C4024	VCKYCY1EF104ZY	AA		R	0.1 25V Ceramic
C4025	VCKYCY1EF104ZY	AA		R	0.1 25V Ceramic
C4026	VCKYCY1EF104ZY	AA		R	0.1 25V Ceramic
C4027	VCKYCY1EF104ZY	AA		R	0.1 25V Ceramic
C4028	VCKYCY1EF104ZY	AA		R	0.1 25V Ceramic
C4029	VCKYCY1HB103KY	AA		R	0.01 50V Ceramic
C4030	VCEASX0JN476MY	AC		R	47 6.3V Electrolytic
C4031	VCKYCY1EF104ZY	AA		R	0.1 25V Ceramic
C4032	VCEASX1CN106MY	AC		R	10 16V Electrolytic
C4033	VCKYCY1EF104ZY	AA		R	0.1 25V Ceramic
C4201	VCEASX1CN106MY	AC		R	10 16V Electrolytic
C4202	VCKYCY1EF104ZY	AA		R	0.1 25V Ceramic
C4203	VCEASX1CN106MY	AC		R	10 16V Electrolytic
C4204	VCKYCY1HB103KY	AA		R	0.01 50V Ceramic
C4205	VCKYCY1EF104ZY	AA		R	0.1 25V Ceramic
C4206	VCKYCY1HB103KY	AA		R	0.01 50V Ceramic
C4207	VCKYCY1EF104ZY	AA		R	0.1 25V Ceramic
C4209	VCKYCY1EF104ZY	AA		R	0.1 25V Ceramic
C4401	VCEASX1CN106MY	AC		R	10 16V Electrolytic
C4402	VCKYCY1EF104ZY	AA		R	0.1 25V Ceramic
C4403	VCKYCY1EF104ZY	AA		R	0.1 25V Ceramic
C4404	VCKYCY1EF104ZY	AA		R	0.1 25V Ceramic
C4405	VCKYCY1EF104ZY	AA		R	0.1 25V Ceramic
C4406	VCKYCY1EF104ZY	AA		R	0.1 25V Ceramic
C4407	VCKYCY1EF104ZY	AA		R	0.1 25V Ceramic
C4408	VCKYCY1EF104ZY	AA		R	0.1 25V Ceramic
C4409	VCKYCY1EF104ZY	AA		R	0.1 25V Ceramic
C4410	VCKYCY1EF104ZY	AA		R	0.1 25V Ceramic
C4411	VCKYCY1EF104ZY	AA		R	0.1 25V Ceramic
C4412	VCEASX1CN106MY	AC		R	10 16V Electrolytic
C4420	VCAAPD1AJ686MY	AE		R	68 10V Electrolytic

NO.	PARTS CODE	PRICE RANK	NEW MARK	PART DELIVERY	DESCRIPTION
[7] DIGITAL Unit (DUNTKD833FM02)					
C4606	VCEASX1CN106MY	AC		R	10 16V Electrolytic
C4607	VCCCCY1HH470JY	AA		R	47p 50V Ceramic
C4608	VCCCCY1HH100DY	AA		R	10p 50V Ceramic
C4610	VCCCCY1HH470JY	AA		R	47p 50V Ceramic
C4611	VCCCCY1HH330JY	AA		R	33p 50V Ceramic
C4612	VCCCCY1HH330JY	AA		R	33p 50V Ceramic
C4613	VCCCCY1HH330JY	AA		R	33p 50V Ceramic
C4614	VCCCCY1HH6R0DY	AA		R	60p 50V Ceramic
C4615	VCCCCY1HH6R0DY	AA		R	60p 50V Ceramic
C4616	VCCCCY1HH6R0DY	AA		R	60p 50V Ceramic
C4617	VCCCCY1HH820JY	AA		R	82p 50V Ceramic
C4618	VCCCCY1HH820JY	AA		R	82p 50V Ceramic
C4619	VCCCCY1HH820JY	AA		R	82p 50V Ceramic
C4621	VCKYCY1EF104ZY	AA		R	0.1 25V Ceramic
C4622	RC-KZA073WJZZY	AD		R	Capacitor
C4623	VCEASX1CN106MY	AC		R	10 16V Electrolytic
C4624	VCKYCY1EF104ZY	AA		R	0.1 25V Ceramic
C4625	VCEASX1CN106MY	AC		R	10 16V Electrolytic
C4626	VCKYCY1EF104ZY	AA		R	0.1 25V Ceramic
C4627	VCKYCY1HB332KY	AA		R	3300p 50V Ceramic
C4628	VCKYCY1HB332KY	AA		R	3300p 50V Ceramic
C4629	VCKYCY1EF104ZY	AA		R	0.1 25V Ceramic
C4632	VCKYCY1HB332KY	AA		R	3300p 50V Ceramic
C4633	VCKYCY1HB332KY	AA		R	3300p 50V Ceramic
C4634	VCEASX1CN106MY	AC		R	10 16V Electrolytic
C4635	VCEASX1CN106MY	AC		R	10 16V Electrolytic
C4636	VCKYCY1HB104KY	AA		R	0.1 50V Ceramic
C4637	VCKYCY1HB104KY	AA		R	0.1 50V Ceramic
C4638	VCKYCY1HB104KY	AA		R	0.1 50V Ceramic
C4639	VCEASX1CN106MY	AC		R	10 16V Electrolytic
C4640	VCEASX1CN106MY	AC		R	10 16V Electrolytic
C4641	VCEASX1CN106MY	AC		R	10 16V Electrolytic
C4701	RC-KZA070WJZZY	AD		R	Capacitor
C4702	VCKYTV1CB105KY	AC		R	1 16V Ceramic
C4703	VCKYCY1EF104ZY	AA		R	0.1 25V Ceramic
C4705	VCKYCY1HB152KY	AA		R	1500p 50V Ceramic
C4706	VCKYCY1EF104ZY	AA		R	0.1 25V Ceramic
C4707	VCAAPD1AJ686MY	AE		R	68 10V Electrolytic
C4708	VCKYCY1EF104ZY	AA		R	0.1 25V Ceramic
C4709	RC-KZA073WJZZY	AD		R	Capacitor
C4710	VCEASY1CN476MY	AC		R	47 16V Electrolytic
C4711	RC-KZA073WJZZY	AD		R	Capacitor
C4713	VCKYCY1EF104ZY	AA		R	0.1 25V Ceramic
C4714	VCKYCY1EF104ZY	AA		R	0.1 25V Ceramic
C4715	VCEASX0JN476MY	AC		R	47 6.3V Electrolytic
C4716	VCKYCY1AB105KY	AB		R	1 10V Ceramic
C4717	VCEASX0JN226MY	AB		R	22 6.3V Electrolytic
D4701	RH-EX1234CEZZY	AE		R	HZU3.6B2TRF
D4702	VHDSFPA73//2EY	AD		R	SFPA-73VL
D4703	VHD1SS352//1Y			R	1SS352(TPH3,F)
FB4001	RBLN-A215WJZZY	AB		R	Balun
FB4002	RBLN-A215WJZZY	AB		R	Balun
FB4003	RBLN-A215WJZZY	AB		R	Balun
FB4004	RBLN-A215WJZZY	AB		R	Balun
FB4005	RBLN-A215WJZZY	AB		R	Balun
FB4006	RBLN-A215WJZZY	AB		R	Balun
FB4007	RBLN-A215WJZZY	AB		R	Balun
FB4008	RBLN-A303WJZZY	AB		R	Balun
FB4009	RBLN-A303WJZZY	AB		R	Balun
FB4201	RBLN-A215WJZZY	AB		R	Balun
FB4202	RBLN-A215WJZZY	AB		R	Balun
FB4401	RBLN-A215WJZZY	AB		R	Balun
FB4402	RBLN-A215WJZZY	AB		R	Balun
FB4601	RBLN-A215WJZZY	AB		R	Balun
FB4602	RBLN-A215WJZZY	AB		R	Balun
FB4603	RBLN-A215WJZZY	AB		R	Balun
FB4701	RBLN-0250TAZZY	AC		R	Balun
IC4001	RH-iXB680WJZZQ	BH		R	STI5516AUCI
IC4002	VHiSN1G08DC-1Y	AD		R	SN74AHC1G08HDCK3
IC4003	VHiBU4228G+-1Y	AD		R	BU4228G-TR
IC4005	VHiSN1GU04C-1Y	AD		R	SN74AHC1GU04HDCK3
IC4201	RH-iXB742WJZZQ	AX		R	K4S641632K-UC75
IC4202	RH-iXB742WJZZQ	AX		R	K4S641632K-UC75
IC4203	RH-iXB921WJZZQ		N	R	
IC4204	VHiBR24L64F-1Y	AK		R	BR24L64F-WE2
IC4401	VHiTCLCX245-2Y	AE		R	TC74LCX245FT(EL)
IC4402	VHiLCX573FT-1Y			R	TC74LCX573FT(EKJ)
IC4403	VHiSN1G08DC-1Y	AD		R	SN74AHC1G08HDCK3
IC4404	VHiLCX244FT-1Y			R	TC74LCX244FT(EL,K)
IC4405	VHiLCX573FT-1Y			R	TC74LCX573FT(EKJ)
IC4406	VHiSN1G32DC-1Y	AD		R	SN74AHC1G32HDCK3
IC4407	VHiSN1G32DC-1Y	AD		R	SN74AHC1G32HDCK3
IC4408	VHiSN1G02DC-1Y	AD		R	SN74AHC1G02HDCK3
IC4604	VHiTSH73CPT-1Y	AL		R	TSH73CPT
IC4701	VHiMP1583+-1Y	AH		R	MP1583DN-LF-Z

NO.	PARTS CODE	PRICE RANK	NEW MARK	PART DELIVERY	DESCRIPTION
[7] DIGITAL Unit (DUNTKD833FM02)					
IC4704	VH i PQ018ENA-1Y	AF		R	PQ018ENA1ZPH
L4601	VPD9M100J1R7NY	AC		R	Peaking 10uH
L4603	VPD9M5R6J1R6NY	AB		R	Peaking 5.6uH
L4604	VPD9M5R6J1R6NY	AB		R	Peaking 5.6uH
L4605	VPD9M5R6J1R6NY	AB		R	Peaking 5.6uH
L4701	RC i L PA214WJZZY	AG		R	Coil
LUG4601	QLUGHA009WJZZY	AC		R	Lug
LUG4602	QLUGHA006WJZZY	AC		R	Lug
LUG4603	QLUGHA006WJZZY	AC		R	Lug
LUG4604	QLUGHA009WJZZY	AC		R	Lug
P4001	QPLGN0463TAZZY	AC		R	Plug
P4003	QPLGN0463TAZZY	AC		R	Plug
Q4001	VS2SC3928AR-1Y	AB		R	2SC3928A-T112-1R
Q4002	VS2SC3928AR-1Y	AB		R	2SC3928A-T112-1R
Q4201	VS2SA1530AR-1Y	AB		R	2SA1530A-T112-1R
Q4401	RH-TXA026WJZZY	AD		R	PBLS2001D,115
Q4601	VS2SC3928AR-1Y	AB		R	2SC3928A-T112-1R
Q4602	VS2SC3928AR-1Y	AB		R	2SC3928A-T112-1R
Q4603	VS2SC3928AR-1Y	AB		R	2SC3928A-T112-1R
Q4604	VS2SC3928AR-1Y	AB		R	2SC3928A-T112-1R
Q4605	VS2SC3928AR-1Y	AB		R	2SC3928A-T112-1R
Q4606	VS2SC3928AR-1Y	AB		R	2SC3928A-T112-1R
Q4607	VS2SC3928AR-1Y	AB		R	2SC3928A-T112-1R
Q4701	VSDTC144EE/-1Y	AA		R	DTC144EETL
Q4702	VSDTC144EE/-1Y	AA		R	DTC144EETL
Q4703	VS2SC3928AR-1Y	AB		R	2SC3928A-T112-1R
Q4704	VSCPH6318+-1Y			R	CPH6318-TL-E
R4001	VRS-CY1JF000JY	AA		R	0 1/16W Metal Oxide
R4002	VRS-CY1JF201FY	AA		R	200 1/16W Metal Oxide
R4003	VRS-CY1JF103JY	AA		R	10k 1/16W Metal Oxide
R4004	VRS-CY1JF000JY	AA		R	0 1/16W Metal Oxide
R4005	VRS-CY1JF103JY	AA		R	10k 1/16W Metal Oxide
R4006	VRS-CY1JF103JY	AA		R	10k 1/16W Metal Oxide
R4007	VRS-CY1JF103JY	AA		R	10k 1/16W Metal Oxide
R4008	VRS-CY1JF103JY	AA		R	10k 1/16W Metal Oxide
R4009	VRS-CY1JF104JY	AA		R	100k 1/16W Metal Oxide
R4010	VRS-CY1JF000JY	AA		R	0 1/16W Metal Oxide
R4011	VRS-CY1JF103JY	AA		R	10k 1/16W Metal Oxide
R4012	VRS-CY1JF103JY	AA		R	10k 1/16W Metal Oxide
R4013	VRS-CY1JF103JY	AA		R	10k 1/16W Metal Oxide
R4015	VRS-CY1JF103JY	AA		R	10k 1/16W Metal Oxide
R4016	VRS-CY1JF101JY	AA		R	100 1/16W Metal Oxide
R4017	VRS-CY1JF103JY	AA		R	10k 1/16W Metal Oxide
R4018	VRS-CY1JF000JY	AA		R	0 1/16W Metal Oxide
R4019	VRS-CY1JF000JY	AA		R	0 1/16W Metal Oxide
R4020	VRS-CY1JF472JY	AA		R	4.7k 1/16W Metal Oxide
R4021	VRS-CY1JF222JY	AA		R	2.2k 1/16W Metal Oxide
R4024	VRS-CY1JF000JY	AA		R	0 1/16W Metal Oxide
R4025	VRS-CY1JF000JY	AA		R	0 1/16W Metal Oxide
R4026	VRS-CY1JF103JY	AA		R	10k 1/16W Metal Oxide
R4027	VRS-CH1JF000JY	AA		R	0 1/16W Metal Oxide
R4028	VRS-CY1JF103JY	AA		R	10k 1/16W Metal Oxide
R4029	VRS-CY1JF330JY	AA		R	33 1/16W Metal Oxide
R4030	VRS-CH1JF470JY	AA		R	47 1/16W Metal Oxide
R4031	VRS-CH1JF470JY	AA		R	47 1/16W Metal Oxide
R4032	VRS-CY1JF103JY	AA		R	10k 1/16W Metal Oxide
R4035	VRS-CY1JF103JY	AA		R	10k 1/16W Metal Oxide
R4036	VRS-CH1JF103JY	AA		R	10k 1/16W Metal Oxide
R4037	VRS-CY1JF103JY	AA		R	10k 1/16W Metal Oxide
R4038	VRS-CY1JF101JY	AA		R	100 1/16W Metal Oxide
R4039	VRS-CY1JF101JY	AA		R	100 1/16W Metal Oxide
R4190	VRS-CY1JF101JY	AA		R	100 1/16W Metal Oxide
R4191	VRS-CY1JF101JY	AA		R	100 1/16W Metal Oxide
R4192	VRS-CY1JF101JY	AA		R	100 1/16W Metal Oxide
R4193	VRS-CY1JF101JY	AA		R	100 1/16W Metal Oxide
R4194	VRS-CY1JF101JY	AA		R	100 1/16W Metal Oxide
R4195	VRS-CY1JF101JY	AA		R	100 1/16W Metal Oxide
R4196	VRS-CY1JF101JY	AA		R	100 1/16W Metal Oxide
R4197	VRS-CY1JF101JY	AA		R	100 1/16W Metal Oxide
R4201	VRS-CH1JF470JY	AA		R	47 1/16W Metal Oxide
R4202	VRS-CH1JF470JY	AA		R	47 1/16W Metal Oxide
R4203	VRS-CH1JF470JY	AA		R	47 1/16W Metal Oxide
R4204	VRS-CH1JF470JY	AA		R	47 1/16W Metal Oxide
R4205	VRS-CH1JF470JY	AA		R	47 1/16W Metal Oxide
R4206	VRS-CH1JF470JY	AA		R	47 1/16W Metal Oxide
R4207	VRS-CH1JF470JY	AA		R	47 1/16W Metal Oxide
R4208	VRS-CH1JF470JY	AA		R	47 1/16W Metal Oxide
R4209	VRS-CH1JF470JY	AA		R	47 1/16W Metal Oxide
R4210	VRS-CY1JF470JY	AA		R	47 1/16W Metal Oxide
R4211	VRS-CH1JF470JY	AA		R	47 1/16W Metal Oxide
R4212	VRS-CH1JF470JY	AA		R	47 1/16W Metal Oxide
R4213	VRS-CH1JF470JY	AA		R	47 1/16W Metal Oxide
R4214	VRS-CH1JF470JY	AA		R	47 1/16W Metal Oxide
R4215	VRS-CH1JF470JY	AA		R	47 1/16W Metal Oxide
R4216	VRS-CH1JF470JY	AA		R	47 1/16W Metal Oxide

NO.	PARTS CODE	PRICE RANK	NEW MARK	PART DELIVERY	DESCRIPTION
[7] DIGITAL Unit (DUNTKD833FM02)					
R4217	VRS-CH1 JF 470 JY	AA		R	47 1/16W Metal Oxide
R4218	VRS-CH1 JF 470 JY	AA		R	47 1/16W Metal Oxide
R4219	VRS-CY1 JF 470 JY	AA		R	47 1/16W Metal Oxide
R4220	VRS-CY1 JF 470 JY	AA		R	47 1/16W Metal Oxide
R4221	VRS-CY1 JF 470 JY	AA		R	47 1/16W Metal Oxide
R4222	VRS-CY1 JF 470 JY	AA		R	47 1/16W Metal Oxide
R4223	VRS-CH1 JF 103 JY	AA		R	10k 1/16W Metal Oxide
R4224	VRS-CH1 JF 103 JY	AA		R	10k 1/16W Metal Oxide
R4225	VRS-CY1 JF 103 JY	AA		R	10k 1/16W Metal Oxide
R4226	VRS-CY1 JF 103 JY	AA		R	10k 1/16W Metal Oxide
R4227	VRS-CY1 JF 103 JY	AA		R	10k 1/16W Metal Oxide
R4228	VRS-CY1 JF 103 JY	AA		R	10k 1/16W Metal Oxide
R4229	VRS-CY1 JF 103 JY	AA		R	10k 1/16W Metal Oxide
R4230	VRS-CY1 JF 103 JY	AA		R	10k 1/16W Metal Oxide
R4231	VRS-CY1 JF 103 JY	AA		R	10k 1/16W Metal Oxide
R4232	VRS-CY1 JF 103 JY	AA		R	10k 1/16W Metal Oxide
R4233	VRS-CY1 JF 470 JY	AA		R	47 1/16W Metal Oxide
R4234	VRS-CY1 JF 470 JY	AA		R	47 1/16W Metal Oxide
R4235	VRS-CY1 JF 470 JY	AA		R	47 1/16W Metal Oxide
R4236	VRS-CY1 JF 470 JY	AA		R	47 1/16W Metal Oxide
R4237	VRS-CY1 JF 470 JY	AA		R	47 1/16W Metal Oxide
R4238	VRS-CY1 JF 470 JY	AA		R	47 1/16W Metal Oxide
R4239	VRS-CY1 JF 470 JY	AA		R	47 1/16W Metal Oxide
R4240	VRS-CY1 JF 470 JY	AA		R	47 1/16W Metal Oxide
R4241	VRS-CY1 JF 470 JY	AA		R	47 1/16W Metal Oxide
R4242	VRS-CY1 JF 470 JY	AA		R	47 1/16W Metal Oxide
R4243	VRS-CY1 JF 470 JY	AA		R	47 1/16W Metal Oxide
R4244	VRS-CY1 JF 470 JY	AA		R	47 1/16W Metal Oxide
R4245	VRS-CY1 JF 562 JY	AA		R	5.6k 1/16W Metal Oxide
R4246	VRS-CY1 JF 470 JY	AA		R	47 1/16W Metal Oxide
R4247	VRS-CY1 JF 103 JY	AA		R	10k 1/16W Metal Oxide
R4248	VRS-CY1 JF 470 JY	AA		R	47 1/16W Metal Oxide
R4249	VRS-CY1 JF 562 JY	AA		R	5.6k 1/16W Metal Oxide
R4250	VRS-CY1 JF 470 JY	AA		R	47 1/16W Metal Oxide
R4251	VRS-CY1 JF 470 JY	AA		R	47 1/16W Metal Oxide
R4401	VRS-CH1 JF 470 JY	AA		R	47 1/16W Metal Oxide
R4402	VRS-CH1 JF 470 JY	AA		R	47 1/16W Metal Oxide
R4403	VRS-CH1 JF 470 JY	AA		R	47 1/16W Metal Oxide
R4404	VRS-CH1 JF 470 JY	AA		R	47 1/16W Metal Oxide
R4405	VRS-CY1 JF 470 JY	AA		R	47 1/16W Metal Oxide
R4406	VRS-CY1 JF 470 JY	AA		R	47 1/16W Metal Oxide
R4407	VRS-CH1 JF 470 JY	AA		R	47 1/16W Metal Oxide
R4408	VRS-CH1 JF 470 JY	AA		R	47 1/16W Metal Oxide
R4409	VRS-CY1 JF 103 JY	AA		R	10k 1/16W Metal Oxide
R4410	VRS-CH1 JF 470 JY	AA		R	47 1/16W Metal Oxide
R4411	VRS-CH1 JF 470 JY	AA		R	47 1/16W Metal Oxide
R4412	VRS-CH1 JF 470 JY	AA		R	47 1/16W Metal Oxide
R4413	VRS-CH1 JF 470 JY	AA		R	47 1/16W Metal Oxide
R4414	VRS-CH1 JF 470 JY	AA		R	47 1/16W Metal Oxide
R4415	VRS-CH1 JF 470 JY	AA		R	47 1/16W Metal Oxide
R4416	VRS-CH1 JF 470 JY	AA		R	47 1/16W Metal Oxide
R4417	VRS-CY1 JF 103 JY	AA		R	10k 1/16W Metal Oxide
R4418	VRS-CY1 JF 470 JY	AA		R	47 1/16W Metal Oxide
R4419	VRS-CY1 JF 103 JY	AA		R	10k 1/16W Metal Oxide
R4420	VRS-CY1 JF 103 JY	AA		R	10k 1/16W Metal Oxide
R4421	VRS-CH1 JF 470 JY	AA		R	47 1/16W Metal Oxide
R4422	VRS-CH1 JF 470 JY	AA		R	47 1/16W Metal Oxide
R4425	VRS-CY1 JF 103 JY	AA		R	10k 1/16W Metal Oxide
R4426	VRS-CY1 JF 103 JY	AA		R	10k 1/16W Metal Oxide
R4427	VRS-CH1 JF 470 JY	AA		R	47 1/16W Metal Oxide
R4428	VRS-CH1 JF 470 JY	AA		R	47 1/16W Metal Oxide
R4429	VRS-CH1 JF 470 JY	AA		R	47 1/16W Metal Oxide
R4430	VRS-CY1 JF 470 JY	AA		R	470 1/16W Metal Oxide
R4431	VRS-CY1 JF 103 JY	AA		R	10k 1/16W Metal Oxide
R4432	VRS-CY1 JF 103 JY	AA		R	10k 1/16W Metal Oxide
R4433	VRS-CY1 JF 470 JY	AA		R	47 1/16W Metal Oxide
R4434	VRS-CY1 JF 470 JY	AA		R	47 1/16W Metal Oxide
R4441	VRS-CY1 JF 103 JY	AA		R	10k 1/16W Metal Oxide
R4447	VRS-CY1 JF 102 JY	AA		R	1k 1/16W Metal Oxide
R4601	VRS-CY1 JF 470 JY	AA		R	47 1/16W Metal Oxide
R4602	VRS-CY1 JF 470 JY	AA		R	47 1/16W Metal Oxide
R4603	VRS-CY1 JF 470 JY	AA		R	47 1/16W Metal Oxide
R4604	VRS-CY1 JF 470 JY	AA		R	47 1/16W Metal Oxide
R4605	VRS-CY1 JF 470 JY	AA		R	47 1/16W Metal Oxide
R4606	VRS-CY1 JF 470 JY	AA		R	47 1/16W Metal Oxide
R4607	VRS-CY1 JF 470 JY	AA		R	47 1/16W Metal Oxide
R4608	VRS-CY1 JF 470 JY	AA		R	47 1/16W Metal Oxide
R4609	VRS-CY1 JF 470 JY	AA		R	47 1/16W Metal Oxide
R4616	VRS-CY1 JF 470 FY	AA		R	47 1/16W Metal Oxide
R4617	VRS-CY1 JF 331 FY	AA		R	330 1/16W Metal Oxide
R4618	VRS-CY1 JF 331 FY	AA		R	330 1/16W Metal Oxide
R4619	VRS-CY1 JF 271 FY	AA		R	270 1/16W Metal Oxide
R4620	VRS-CY1 JF 271 FY	AA		R	270 1/16W Metal Oxide
R4621	VRS-CY1 JF 271 FY	AA		R	270 1/16W Metal Oxide
R4622	VRS-CY1 JF 271 FY	AA		R	270 1/16W Metal Oxide

LC-46/52XD1E-RU

NO.	PARTS CODE	PRICE RANK	NEW MARK	PART DELIVERY	DESCRIPTION
[7] DIGITAL Unit (DUNTKD833FM02)					
R4623	VRS-CY1JF271FY	AA		R	270 1/16W Metal Oxide
R4624	VRS-CY1JF271FY	AA		R	270 1/16W Metal Oxide
R4626	VRS-CY1JF000JY	AA		R	0 1/16W Metal Oxide
R4627	VRS-CY1JF272FY	AA		R	2.7k 1/16W Metal Oxide
R4628	VRS-CY1JF242FY	AA		R	2.4k 1/16W Metal Oxide
R4629	VRS-CY1JF470JY	AA		R	47 1/16W Metal Oxide
R4630	VRS-CY1JF470JY	AA		R	47 1/16W Metal Oxide
R4631	VRS-CY1JF471JY	AA		R	470 1/16W Metal Oxide
R4632	VRS-CY1JF471JY	AA		R	470 1/16W Metal Oxide
R4633	VRS-CY1JF472JY	AA		R	4.7k 1/16W Metal Oxide
R4634	VRS-CY1JF240JY	AA		R	24 1/16W Metal Oxide
R4635	VRS-CY1JF240JY	AA		R	24 1/16W Metal Oxide
R4636	VRS-CY1JF240JY	AA		R	24 1/16W Metal Oxide
R4637	VRS-CY1JF240JY	AA		R	24 1/16W Metal Oxide
R4638	VRS-CY1JF472JY	AA		R	4.7k 1/16W Metal Oxide
R4639	VRS-CY1JF471JY	AA		R	470 1/16W Metal Oxide
R4640	VRS-CY1JF471JY	AA		R	470 1/16W Metal Oxide
R4643	VRS-CY1JF470JY	AA		R	47 1/16W Metal Oxide
R4644	VRS-CY1JF470JY	AA		R	47 1/16W Metal Oxide
R4645	VRS-CY1JF470JY	AA		R	47 1/16W Metal Oxide
R4646	VRS-CY1JF470JY	AA		R	47 1/16W Metal Oxide
R4647	VRS-CY1JF470JY	AA		R	47 1/16W Metal Oxide
R4648	VRS-CY1JF470JY	AA		R	47 1/16W Metal Oxide
R4649	VRS-CY1JF470JY	AA		R	47 1/16W Metal Oxide
R4650	VRS-CY1JF470JY	AA		R	47 1/16W Metal Oxide
R4651	VRS-CY1JF183JY	AA		R	18k 1/16W Metal Oxide
R4652	VRS-CY1JF183JY	AA		R	18k 1/16W Metal Oxide
R4657	VRS-CY1JF101JY	AA		R	100 1/16W Metal Oxide
R4658	VRS-CY1JF101JY	AA		R	100 1/16W Metal Oxide
R4659	VRS-CY1JF331FY	AA		R	330 1/16W Metal Oxide
R4660	VRS-CY1JF473JY	AA		R	47k 1/16W Metal Oxide
R4661	VRS-CY1JF473JY	AA		R	47k 1/16W Metal Oxide
R4662	VRS-CY1JF271FY	AA		R	270 1/16W Metal Oxide
R4663	VRS-CY1JF271FY	AA		R	270 1/16W Metal Oxide
R4664	VRS-CY1JF271FY	AA		R	270 1/16W Metal Oxide
R4665	VRS-CY1JF161FY	AA		R	160 1/16W Metal Oxide
R4666	VRS-CY1JF103JY	AA		R	10k 1/16W Metal Oxide
R4667	VRS-CY1JF161FY	AA		R	160 1/16W Metal Oxide
R4668	VRS-CY1JF103JY	AA		R	10k 1/16W Metal Oxide
R4669	VRS-CY1JF161FY	AA		R	160 1/16W Metal Oxide
R4670	VRS-CY1JF103JY	AA		R	10k 1/16W Metal Oxide
R4672	VRS-CY1JF103JY	AA		R	10k 1/16W Metal Oxide
R4673	VRS-CY1JF103JY	AA		R	10k 1/16W Metal Oxide
R4674	VRS-CY1JF000JY	AA		R	0 1/16W Metal Oxide
R4675	VRS-CY1JF470JY	AA		R	47 1/16W Metal Oxide
R4701	VRS-CY1JF474FY	AA		R	470k 1/16W Metal Oxide
R4702	VRS-CY1JF273FY	AA		R	27k 1/16W Metal Oxide
R4703	VRS-CY1JF153FY	AA		R	15k 1/16W Metal Oxide
R4704	VRS-CY1JF562JY	AA		R	5.6k 1/16W Metal Oxide
R4705	VRS-CY1JF103JY	AA		R	10k 1/16W Metal Oxide
R4706	VRS-CY1JF103JY	AA		R	10k 1/16W Metal Oxide
R4707	VRS-CY1JF103JY	AA		R	10k 1/16W Metal Oxide
R4708	VRS-CY1JF332JY	AA		R	3.3k 1/16W Metal Oxide
R4709	VRS-TX2HF000JY	AB		R	0 1/2W Metal Oxide
R4710	VRS-CY1JF101JY	AA		R	100 1/16W Metal Oxide
R4711	VRS-TX2HF000JY	AB		R	0 1/2W Metal Oxide
R4712	VRS-CY1JF103JY	AA		R	10k 1/16W Metal Oxide
R4713	VRS-TX2HF1R0JY	AB		R	1 1/2W Metal Oxide
R4715	VRS-TX2HF000JY	AB		R	0 1/2W Metal Oxide
R4716	VRS-TX2HF000JY	AB		R	0 1/2W Metal Oxide
R4717	VRS-CY1JF101JY	AA		R	100 1/16W Metal Oxide
SC4601	QCNCWA202WJZZY	AK		R	Connector
SC4602	QSOCNA003WJZZY	AM		R	Socket
X4001	RCRSC0032TAZZY	AG		R	Crystal
X4002	RCRUAA075WJZZY	AQ		R	
[8] DUNTKD910FM01 (KEY Unit)					
D151	RH-EX0646GEZZY	AA		R	MTZJT-7215B
D152	RH-EX0646GEZZY	AA		R	MTZJT-7215B
D155	RH-EX0646GEZZY	AA		R	MTZJT-7215B
P151	QPLGNA058WJZZ	AC		R	Plug
R151	VRD-RA2BE822JY	AA		R	8.2k 1/8W Carbon
R152	VRD-RA2BE123JY	AA		R	12k 1/8W Carbon
R153	VRD-RA2BE822JY	AA		R	8.2k 1/8W Carbon
S151	QSW-K0003AJZZ+	AB		R	Switch
S152	QSW-K0003AJZZ+	AB		R	Switch
S153	QSW-K0003AJZZ+	AB		R	Switch
S154	QSW-K0003AJZZ+	AB		R	Switch
S155	QSW-K0003AJZZ+	AB		R	Switch
S157	QSW-K0003AJZZ+	AB		R	Switch

NO.	PARTS CODE	PRICE RANK	NEW MARK	PART DELIVERY	DESCRIPTION
[9] DUNTKD909FM01 (R/C Unit)					
C102	VCKYTV1CF225ZY	AB		R	2.2 16V Ceramic
C104	VCEASX1CN106MY	AC		R	10 16V Electrolytic
C105	VCKYCY1HF103ZY	AA		R	0.01 50V Ceramic
C107	VCEASY1CN107MY	AC		R	100 16V Electrolytic
D101	RH-EXA092WJZZY	AB		R	UDZSTE-1712B
D103	RH-PX0421CEZZY	AD		R	CL-165HR/YG-D-T
D114	RH-PX0421CEZZY	AD		R	CL-165HR/YG-D-T
D115	RH-PX0421CEZZY	AD		R	CL-165HR/YG-D-T
IC101	VH i TPS850+-1Y	AG		R	TPS850
P101	QPLGNA333WJZZY	AD		R	Plug
Q102	VS2SC3928AR-1Y	AB		R	2SC3928A-T112-1R
Q103	VS2SC3928AR-1Y	AB		R	2SC3928A-T112-1R
Q106	VS2SC3928AR-1Y	AB		R	2SC3928A-T112-1R
Q107	VS2SC3928AR-1Y	AB		R	2SC3928A-T112-1R
R101	VRS-CY1JF101JY	AA		R	100 1/16W Metal Oxide
R102	VRS-CY1JF103JY	AA		R	10k 1/16W Metal Oxide
R104	VRS-CY1JF273JY	AA		R	27k 1/16W Metal Oxide
R108	VRS-CY1JF161JY	AA		R	160 1/16W Metal Oxide
R109	VRS-CY1JF821JY	AA		R	820 1/16W Metal Oxide
R121	VRS-CY1JF821JY	AA		R	820 1/16W Metal Oxide
R122	VRS-CY1JF161JY	AA		R	160 1/16W Metal Oxide
R123	VRS-CJ1JF103JY	AA		R	10k 1/16W Metal Oxide
R124	VRS-CJ1JF103JY	AA		R	10k 1/16W Metal Oxide
R135	VRS-CY1JF000JY	AA		R	0 1/16W Metal Oxide
RMC101	RRMUA053WJZZ	AE		R	Remote Receiver
SLD101	PSLDM4646CEFW	AD		R	Shield

[10] CABINET PARTS

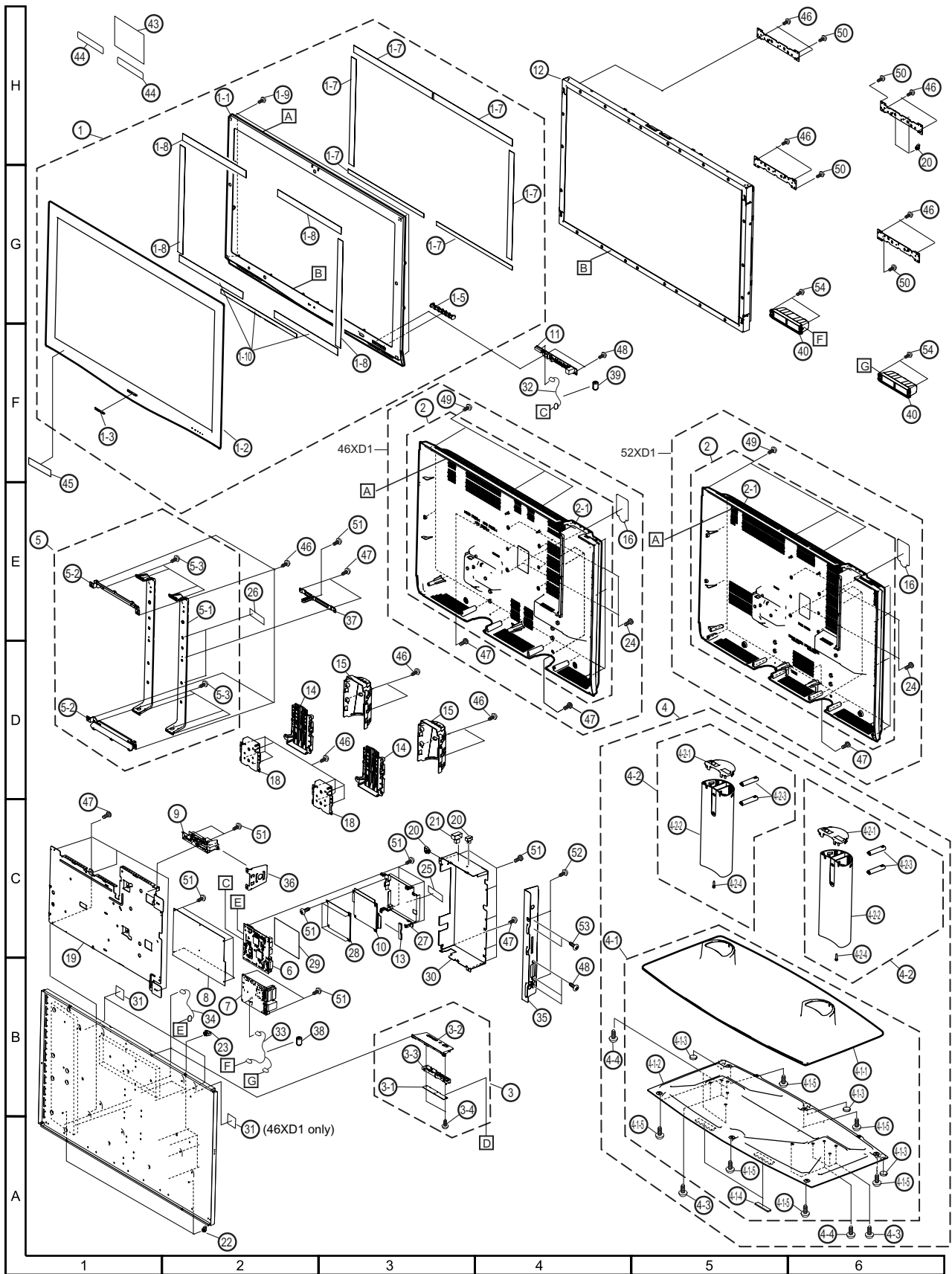

NO.	PARTS CODE	PRICE RANK	NEW MARK	PART DELIVERY	DESCRIPTION
[10] CABINET PARTS					
1	CCABAB605WJ01		N	R	Front Cabinet Ass'y (46XD1)
1	CCABAB606WJ01		N	R	Front Cabinet Ass'y (52XD1)
1-1	Not Available	-	N	-	Front Cabinet (46XD1)
1-1	Not Available	-	N	-	Front Cabinet (52XD1)
1-2	GCOVAB920WJSA		N	R	Cover (46XD1)
1-2	GCOVAB922WJSA		N	R	Cover (52XD1)
1-3	HBDGBA061WJSA			R	SHARP Badge
1-5	HDECQA667WJSA			R	LED Cover
1-7	PSPAHA884WJZZ		N	R	Masking Himeron-H x6 (52XD1)
1-7	PSPAHA886WJZZ		N	R	Masking Himeron-H x6 (46XD1)
1-8	PSPAZB269WJZZ		N	R	Front Cover Tape x 4 (52XD1)
1-8	PSPAZB268WJZZ		N	R	Front Cover Tape x 4 (46XD1)
1-9	XJPS730P08WS0	AA		R	Screw x 4
1-10	PSPAZB194WJZZ			R	Front Cover Tape x 3 (52XD1)
1-10	PSPAZB193WJZZ			R	Front Cover Tape x 3 (46XD1)
2	CCABBA947WJ01		N	R	Rear Cabinet Ass'y (46XD1)
2	CCABBA948WJ01		N	R	Rear Cabinet Ass'y (52XD1)
2-1	Not Available	-	N	-	Rear Cabinet (46XD1)
2-1	Not Available	-	N	-	Rear Cabinet (52XD1)
3	CCOVAB923WJ01		N	R	Top Cover Ass'y
3-1	DUNTKD910FM01		N	R	Key PWB Unit
3-2	Not Available	-	N	-	Top Cover
3-3	JBTN-A615WJKA		N	R	Button
3-4	XEBS930P10000	AA		R	Screw x 2
4	CDAi-A325WJ04			R	Stand Ass'y
4-1	CDAi-A325WJ03		N	R	Stand
4-1-1	Not Available	-	N	-	Stand Base Cover
4-1-2	LANGKA887WJZZ			R	Base Angle
4-1-3	PSPAZB181WJZZ			R	Leg Cushion A x 3
4-1-4	PSPAZB182WJZZ			R	Leg Cushion B x 2
4-1-5	XEBS940P10000	AB		R	Screw x 6
4-2	CDAi-A326WJ01			R	Stand x 2
4-2-1	GCOVAB815WJKA			R	Cover
4-2-2	GDAi-A326WJSA		N	R	Stand
4-2-3	HDECQA670WJKA		N	R	Decoration Plate x 2
4-2-4	NSFTZA181WJF7			R	Shaft
4-3	LX-BZA162WJF7			R	Screw x 6
4-4	LX-BZA163WJF7			R	Screw x 4
5	CANGTA359WJ01		N	R	Center Angle Ass'y (52XD1)
5	CANGTA363WJ01		N	R	Center Angle Ass'y (46XD1)
5-1	Not Available	-	N	-	Center Angle x 2
5-2	LANGKA800WJFW		N	R	LCD Angle x 2
5-3	XBBS740P08000	AA		R	Screw x 8
6	DUNTKD915FM01		N	R	Main PWB Unit
7	DUNTKD604FM11		N	R	AV PWB Unit
8	RDENCA204WJQZ		N	R	Power PWB Unit
9	DUNTKD833FM02			R	D-Tuner PWB Unit
10	DUNTKD628FM06		N	R	Digital PWB Unit
11	DUNTKD909FM01			R	R/C PWB Unit
12	R1LK520D3LZ1A		N	R	52" Panel Unit
12	R1LK460D3LZ1AZ		N	R	46" Panel Unit
13	GCOVAB586WJKA			R	PC Card Cover
14	GCOVAB924WJKA		N	R	Bottom Cover Front x 2
15	GCOVAB925WJKA		N	R	Bottom Cover Rear x 2
16	HiNDPB875WJSA		N	R	Model Label (52XD1) for E/F/K
16	HiNDPB876WJSA		N	R	Model Label (52XD1) for I
16	HiNDPB877WJSA		N	R	Model Label (52XD1) for R
16	HiNDPB878WJSA		N	R	Model Label (46XD1) for E/F/K
16	HiNDPB879WJSA		N	R	Model Label (46XD1) for I
16	HiNDPB880WJSA		N	R	Model Label (46XD1) for R
17	LANGKA801WJFW		N	R	LCD Side Angle x4
18	LANGTA361WJN1		N	R	Stand Angle x 2
19	LCHSMA338WJFW		N	R	Chassis Tray
20	LHLDWA092WJZZ	AB		R	Holder x 4
21	LHLDW1173CEZZ	AB		R	Holder
22	LHLDW1033CE00	AB		R	Holder x 2
23	LHLDWA141WJZZ			R	Holder
24	LX-BZA170WJF9		N	R	Screw x 4
25	PMLT-A165WJZZ		N	R	Gasket x 2
26	PMLT-A073WJZZ			R	Conductive Tape x 2
27	PSLDMA943WJFW			R	Digital Shield
28	PSLDMB056WJFW			R	Digital Back Shield
29	PSLDMB055WJFW		N	R	Main Shield
30	PSLDMB057WJFW		N	R	Full Shield
31	PSPAHA975WJZZ		N	R	Spacer x 3 (46XD1) Spacer x 2 (52XD1)
32	QCNW-E854WJQZ		N	R	Connecting Cord (46XD1)
33	QCNW-E855WJQZ		N	R	Connecting Cord (46XD1)
32	QCNW-F044WJQZ		N	R	Connecting Cord (52XD1)
33	QCNW-F045WJQZ		N	R	Connecting Cord (52XD1)
34	QCNW-F050WJQZ		N	R	Connecting Cord
35	LANGKA889WJSA		N	R	Tarminal Angle
36	QEARZA102WJFW		N	R	Tuner Earth Plate
37	QEARZA103WJFW		N	R	Earth Angle
38	RCORF0103CEZZ	AK		R	Core
39	RCORFA023WJZZ	AK		R	Core

NO.	PARTS CODE	PRICE RANK	NEW MARK	PART DELIVERY	DESCRIPTION
[10] CABINET PARTS					
40	RSP-ZA201WJZZ		N	R	Speaker x 2
43	TLABN0134BMZZ			R	Sees Label x 2
44	TLABNB415WJZZ			R	No. Label
45	TLABZB315WJZZ		N	R	Pop Label
46	XBBS740P08000	AA		R	Screw x 16
47	XBBS830P06000	AA		R	Screw x 12
48	XEBS930P10000	AA		R	Screw x 5
49	XEBS940P20000	AB		R	Screw x 13 (46XD1) Screw x 18 (52XD1)
50	XEBSN40P10000	AB		R	Screw x 4
51	XJPS730P08WS0	AA		R	Screw x 22
52	XJPS730P06WS0			R	Screw x 2
53	XBPS830P06000	AA		R	Screw x 2
54	LX-HZA003WJFN	AC		R	Screw x 4

[11] SUPPLIED ACCESSORIES

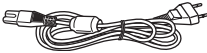
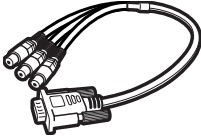
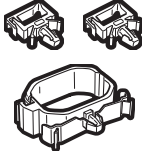
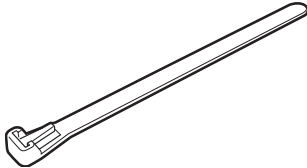
Remote control unit	AC cord	RCA to 15-pin D-sub adapter
X1 	X2  *The shape of plug varies in some countries.	X3 
Cable clamp	Cable band	
X5, X7 	X6 	

NO.	PARTS CODE	PRICE RANK	NEW MARK	PART DELIVERY	DESCRIPTION
[11] SUPPLIED ACCESSORIES					
X1	RRMCGA538WJSA		N	R	Infrared R/C (46XD1)
X1	RRMCGA533WJSA		N	R	Infrared R/C (52XD1)
X2	QACCKA021WJPZ			R	AC Cord for E/F/I/R
X2	QACCBA073WJPZ			R	AC Cord for K
X3	QCNWGA075WJPZ	AU		R	D-Sub 15Pin-RCA
X4	TiNS-C596WJZZ		N	R	Operation Manual (English)
X4	TiNS-C597WJZZ		N	R	Operation Manual (Swedish)
X4	TiNS-C598WJZZ		N	R	Operation Manual (Polish)
X4	TiNS-C599WJZZ		N	R	Operation Manual (Russian)
X5	LHLDWA012WJKZ	AC		R	Cable Clamp x 2
X6	LHLDWA083WJ00	AD		R	Cable Pad
X7	LHLDWA131WJKZ	AE		R	Cable Clamp
X8	UBATUA009WJZZ	AD		R	Battery



[12] PACKING PARTS (NOT REPLACEMENT ITEM)

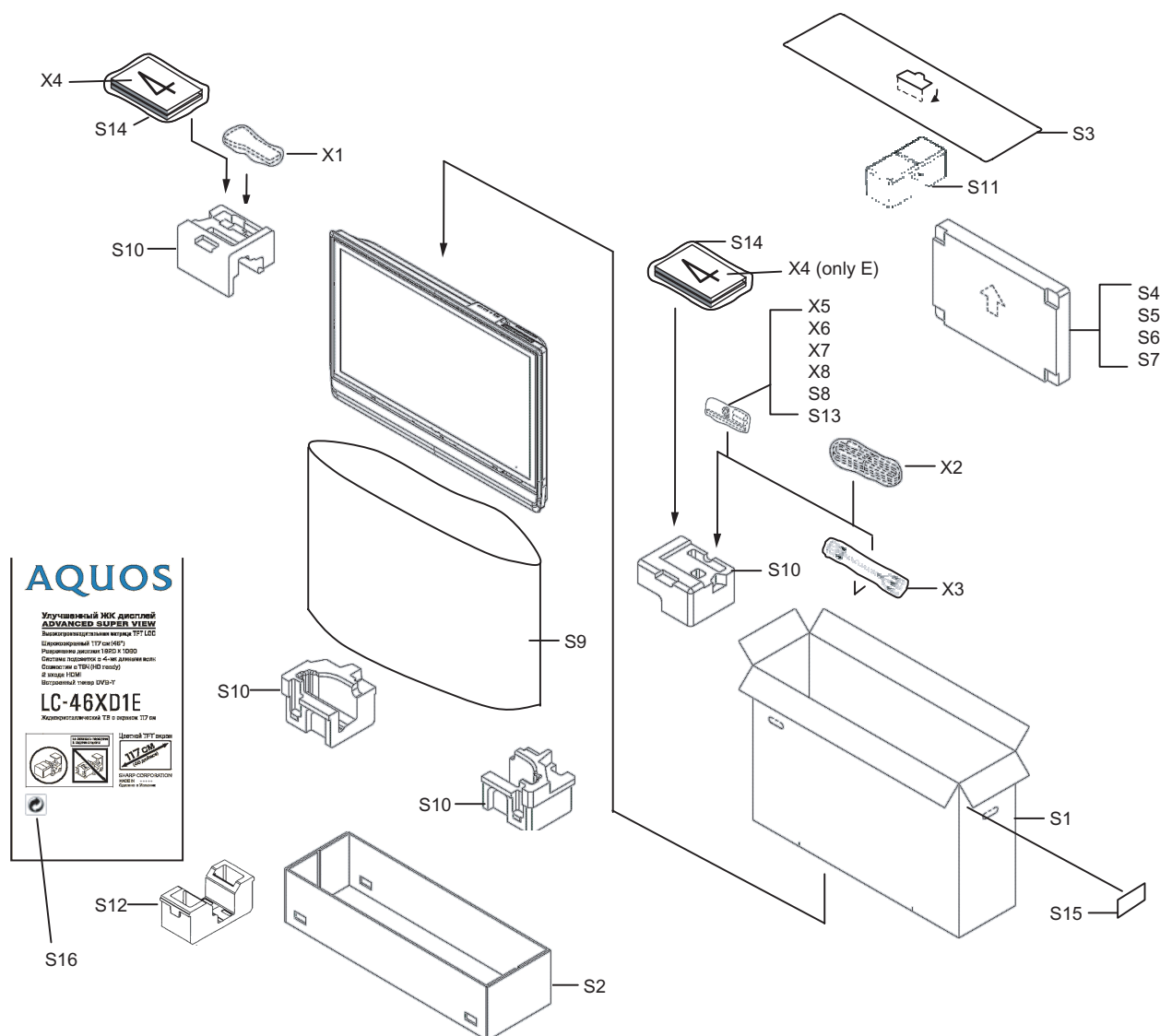

NO.	PARTS CODE	PRICE RANK	NEW MARK	PART DELIVERY	DESCRIPTION
[12] PACKING PARTS (NOT REPLACEMENT ITEM)					
S1	SPAKCD118WJZZ	-	N	-	Packing Case Top (46XD1) for E/F//K
S1	SPAKCD119WJZZ	-	N	-	Packing Case Top (46XD1) for R
S2	SPAKCD134WJZZ	-	N	-	Packing Case Bottom (46XD1)
S1	SPAKCD116WJZZ	-	N	-	Packing Case Top (52XD1) for E/F//K
S1	SPAKCD117WJZZ	-	N	-	Packing Case Top (52XD1) for R
S2	SPAKCD126WJZZ	-	N	-	Packing Case Bottom (52XD1)
S3	SPAKFB140WJZZ	-	N	-	Top Pad (46XD1)
S3	SPAKFB141WJZZ	-	N	-	Top Pad (52XD1)
S4	SPAKFB108WJZZ	-	-	-	Stand Case
S5	SPAKFB114WJZZ	-	N	-	Stand Pad
S6	SPAKPA778WJZZ	-	-	-	Mirror Mat Base
S7	SPAKPA779WJZZ	-	-	-	Mirror Mat Supp x 2
S8	SSAKHA025WJZZ	-	-	-	Polyethylene Bag
S9	SPAKPA711WJZZ	-	N	-	Wrapping Paper (46XD1)
S9	SPAKPA712WJZZ	-	N	-	Wrapping Paper (52XD1)
S10	SPAKXB311WJZZ	-	N	-	Pad x 4 (46XD1)
S10	SPAKXB308WJZZ	-	N	-	Pad x 4 (52XD1)
S11	SPAKXB309WJZZ	-	-	-	EPS Center Top (52XD1)
S11	SPAKXB315WJZZ	-	-	-	EPS Center Top (46XD1)
S12	SPAKXB310WJZZ	-	N	-	EPS Center Bottom (52XD1)
S12	SPAKXB316WJZZ	-	N	-	EPS Center Bottom (46XD1)
S13	SSAKAA009WJZZ	-	-	-	Polyethylene Bag for W/S Band
S14	SSAKAA010WJZZ	-	-	-	A4 Polyethylene Bag
S15	TLABKA002WJZZ	-	-	-	Case No Label
S16	TLABKA050WJZZ	-	-	-	Green Dot Label only F

LC-46/52XD1E-RU

NO.	PARTS CODE	PRICE RANK	NEW MARK	PART DELIVERY	DESCRIPTION
[13] SERVICE JIGS (USER FOR SERVICING)					
A	QCNW-C222WJQZ	AW		R	80pins, x2used, LCD Cont. to LCD Panel Unit
B	QCNW-E687WJQZ		N	R	14pins, (LA)
C	QCNW-E688WJQZ		N	R	8pins, (LB)
D	QCNW-E689WJQZ		N	R	4-20pins, (PL)
E	QCNW-E690WJQZ		N	R	41pins, (LV)
F	QCNWGA015WJPZ	AK		R	Interface Cable, 9pins, D-sub - Mini DIN, (AN-AIRS)
G	QCNWKA011WJZZ	BH	N	S	33pins, Digital Unit to Main Unit
H	QCNWKA012WJZZ	BP	N	S	Digital Software Writing Jig