

S/M No.: FRQ501DF01







SxS Refrigerator Service Manual









Q600 series..

1. Safety Warnings & Cautions

For your safety, please observe following items







◆ Please read [Cautions for Safety] carefully in advance and use the refrigerator correctly.			
 Warning	This indicates that death or Serious injuries may occur As a result of not observing this warning.	 Caution	This indicates that minor to moderate injuries may occur as a result of not observing this warning.
◆ Meaning of marking			
	Don't Disassemble.		Prohibited / Don't try to do it.
	Disconnect the power plug.		Enforced / You should observe instructions.











 Warning	
 <p>Do not install refrigerator in humid environments.</p> <p>◇ If electrical insulation were weakened, it would cause electric shock or fire outbreak.</p>	 <p>Before disposing of refrigerator, remove the rubber packing of the doors.</p> <p>◇ Children can lock themselves in the refrigerator and may be suffocated.</p>
 <p>When inserting the power plug, the direction of the electrical cord is downward.</p> <p>◇ When the direction of cord is inserted upward, it may be damaged and causing short circuit and overheat. then electric shock or fire outbreak may occur.</p>	 <p>When connecting the power plug, make sure it is fastened certainly.</p> <p>◇ Electrical insulation will be weakened and causing electric shock or fire outbreak.</p>
 <p>When the power cord is damaged, please make a call for a service.</p> <p>◇ It may cause fire outbreak, electric shock or short circuit.</p>	 <p>When you feel a combustible gas leaking, air the area so that the refrigerator does not exposed to gas.</p> <p>◇ A spark at an electrical contact point may cause an explosion, fire or burning damage.</p>



Warning

	Don't hold the power plug with a wet hand.		Don't use a branched electrical outlet.
	◇ It may cause electric shock.		◇ Multi-branched power connection may cause abnormal overheat and a fire outbreak. ◇ Use a single-connection electrical outlet with rated 220V or more.
	Be sure the power supply is 220V.		Don't use a damaged power cord or plug or a loose outlet.
	◇ Otherwise, a fire outbreak, electric shock or disorder may be caused.		◇ They may cause short circuit and overheat, so that electric shock or a fire outbreak may occur.
	The power plug or cable shall not be pressed by the refrigerator or other things.		When pulling off the electric plug, avoid holding only the cable.
	◇ Damage may be caused, followed by a fire outbreak.		◇ The cable may be damaged, causing electric shock or a fire outbreak. ◇ Be sure to hold the power plug to pull it off.
	Don't let the power cord touched by a heater.		Don't put a container filled with water on it.
	◇ Damaged cord may cause a fire outbreak or electric shock. ◇ If the cord is damaged, stop using it and ask for a change by the service center.		◇ If water is spilt, insulation of the electrical parts may be deteriorated, causing short circuit, electric shock or a fire outbreak.
	Don't spill water on the main body or inside.		Don't adjust the shelf with food on it.
	◇ Electrical insulation may be deteriorated, causing electric shock or a fire outbreak.		◇ It may fall down to hurt you.
	Don't hold the door and pull it down.		Don't climb over the refrigerator.
	◇ The refrigerator may fall down or your hand may be squeezed and harmed.		◇ It may be overturned and hurt you.
	Never disassemble or modify it.		Don't let the power cord pressed by heavy things nor pull or bend it hard.
	◇ A fire outbreak or malfunctioning may occur.		◇ Damaged coating may cause a fire or electric shock.
	Don't use flammable spray nearby.		Don't put combustibles inside.
	◇ Spark at a contact point may cause a fire outbreak.		◇ Thinner, benzene, LP gas and adhesive may catch fire or cause explosion.

 Warning	
 <p>Don't put medicine or academic materials inside.</p> <p>◇ Don't put materials that strict temperature control is needed for in a domestic refrigerator.</p>	 <p>When the fuse is exchanged, use one with the same capacity.</p> <p>◇ Otherwise, fire may be caused.</p>
 <p>When you put your hand in the machine room at the rear bottom, be sure to unplug the power connection.</p> <p>◇ Otherwise, electric shock or burning may occur.</p>	 <p>Grounding shall not be onto a water pipe, a gas pipe, a telephone line or a lightening rod.</p> <p>◇ Fire or electric shock may occur. ◇ For grounding, be sure to ask the seller.</p>
 <p>When changing the light inside, be sure to disconnect the power.</p> <p>◇ Electric shock may occur.</p>	 <p>Solid grounding shall be made.</p> <p>◇ Short circuit by a disorder may cause electric shock. ◇ For grounding, be sure to ask the seller.</p>

 Caution	
 <p>When changing the light inside, wear gloves so that you may not to be burned or hurt by a breaking.</p>	 <p>Don't eat odorous or color-changed food.</p> <p>◇ Long keeping even in the fridge or Freezer may spoil food.</p>
 <p>When moving it, raise the adjustment feet.</p> <p>◇ Otherwise, the floor may be damaged. ◇ A protection cover shall be used on a damage-prone floor.</p>	 <p>When moving it, hold the adjustment feet and the rear upper part.</p> <p>◇ When holding the rear upper part, be careful not to let your hand slip. ◇ If it slips, it may be hurt.</p>
 <p>Don't put your hand under the bottom of the refrigerator.</p> <p>◇ If you do while cleaning, you may get hurt on the sharp steel sheet.</p>	 <p>Don't touch the food or containers in the fridge or freezing compartment with a wet hand.</p> <p>◇ You may suffer from frostbite.</p>
 <p>Don't put your hand on the compressor or the pipes at the rear bottom.</p> <p>◇ Those parts are hot while in or right after operation and so they may burn you.</p>	 <p>If it is not in use for long, unplug the power cord.</p> <p>◇ Otherwise, fire outbreak may occur.</p>
 <p>Don't put a bottle in the Freezer.</p> <p>◇ It may be broken and hurt you.</p>	

2. Product Specification

2-1. Product Specification

Items		Product Specification	
Model Name		FRQ-19D... (Dispenser only)	FRQ-19F... (Dispenser + H/bar)
(Effective Capacity	Total Capacity	512ℓ	
	Freezing Compart.	4star: 134ℓ / 2star: 25ℓ	
	Fridge Compart.	353ℓ	
External Size_mm (WidthXDepthXHeight)		912X795.8X1771	
Heating Device Rated Input		250 W	
Refrigerator Kind		Indirect cooling type	
Cooling Media / Sealed Quant'y		R600a (0.064kg) or R-134a (0.160kg)	
Climate Grade		SN ~ T	
Weight		97 kg	100 kg

2-2. Electrical Part Specification

Items		Product Specification	
Model Name		FRQ-19D... (Dispenser only)	FRQ-19F... (Dispenser + H/bar)
Freezing Performance		4-Star	
Freezing Parts	Evaporator	FIN TYPE	
	Condenser	Forced circulation type	
	dryer	MOLECULAR SIEVE XH-9	
	Capillary Tube	IDΦ0.7 X 0.55t X L2,365	
Defrosting Parts	Defrosting Heater	250W	
	D-sensor (Type/Return Temperature)	PBN-43 / 13℃	
	Temperature Fuse	250V / 10A / 77 (+0,-4)℃	

Items		Specification		
Model Name		FRQ-19D... (Dispenser only)	FRQ-19F... (Dispenser + H/bar)	
Other Electronic Unit Spec.	Main Fuse	AC250V /12A		
	Home-bar Heater	230V / 10W (Control per RT & time)		
	Freezing Compart.(F) Fan Motor	DC12V / ϕ 140		
	Condenser(C) Fan Motor	DC12V / ϕ 150		
	Freezing Compart.(R) Damper	DC12V		
	Switchable Room Damper	-		
	Freezer Light	LED (DC12V / 1.20W)		
	Fridge Light	LED (DC12V / 1.69W)		
	Freez./Fridge Compart. Door Switch	SP101B-2D1 (AC 250 V, 0.5A)		
	Home-bar Door Switch	-	DC 12V / RS-D4 (REED S/W + MAGNET)	
	power cord	AC250V 16A(VDE)		
	F / R-sensor	N3RC-K32D / N3JC-K41A		
	ICING / FLOW-sensor	N3JC-K35D-D94 / SH-F 110L		

2-3. Controlled Temperature of the Freezing & Fridges

Freezer			Fridge		
Stage	Display	ON / OFF	Stage	Display	ON / OFF
Weak	-16	-12.0 / -16.0	Weak	8	9.4 / 9.9
Weak-to-medium1	-17	-14.8 / -18.8	Weak-to-medium1	7	8.5 / 8.9
Weak-to-medium2	-18	-15.8 / -19.8	Weak-to-medium2	6	7.4 / 7.9
Medium	-19	-16.8 / -20.8	Medium	5	6.5 / 7.0
Medium-to-strong1	-20	-17.4 / -21.4	Medium-to-strong1	4	5.5 / 6.0
Medium-to-strong2	-21	-19.0 / -23.0	Medium-to-strong2	3	4.5 / 5.0
Strong	-22	-22.0 / -26.0	Strong	2	3.5 / 3.9
Quick	-22	-	Quick	2	-

3. Wiring Diagram

3-1. Normal Compressor

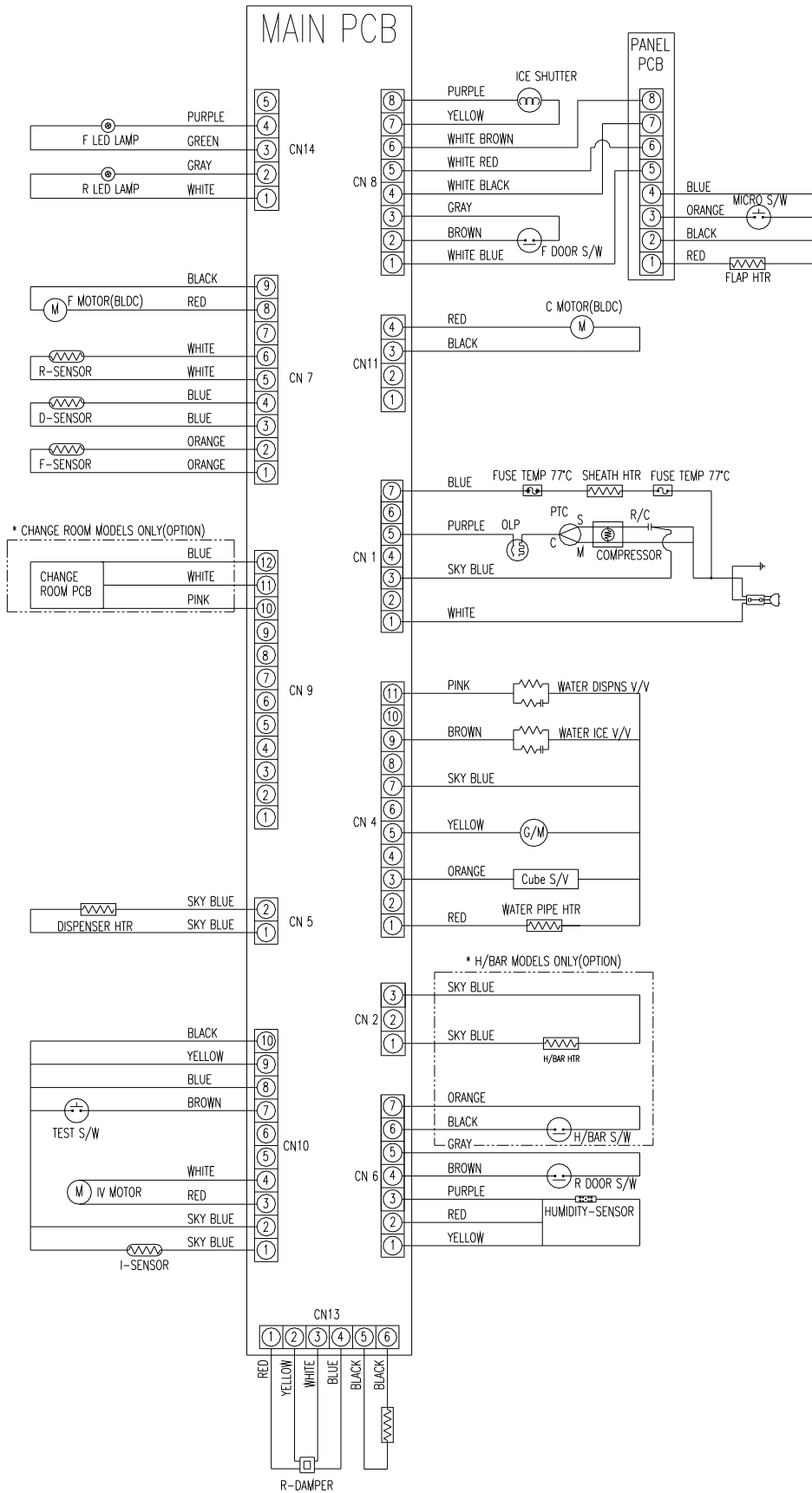

3-2. Inverter Compressor

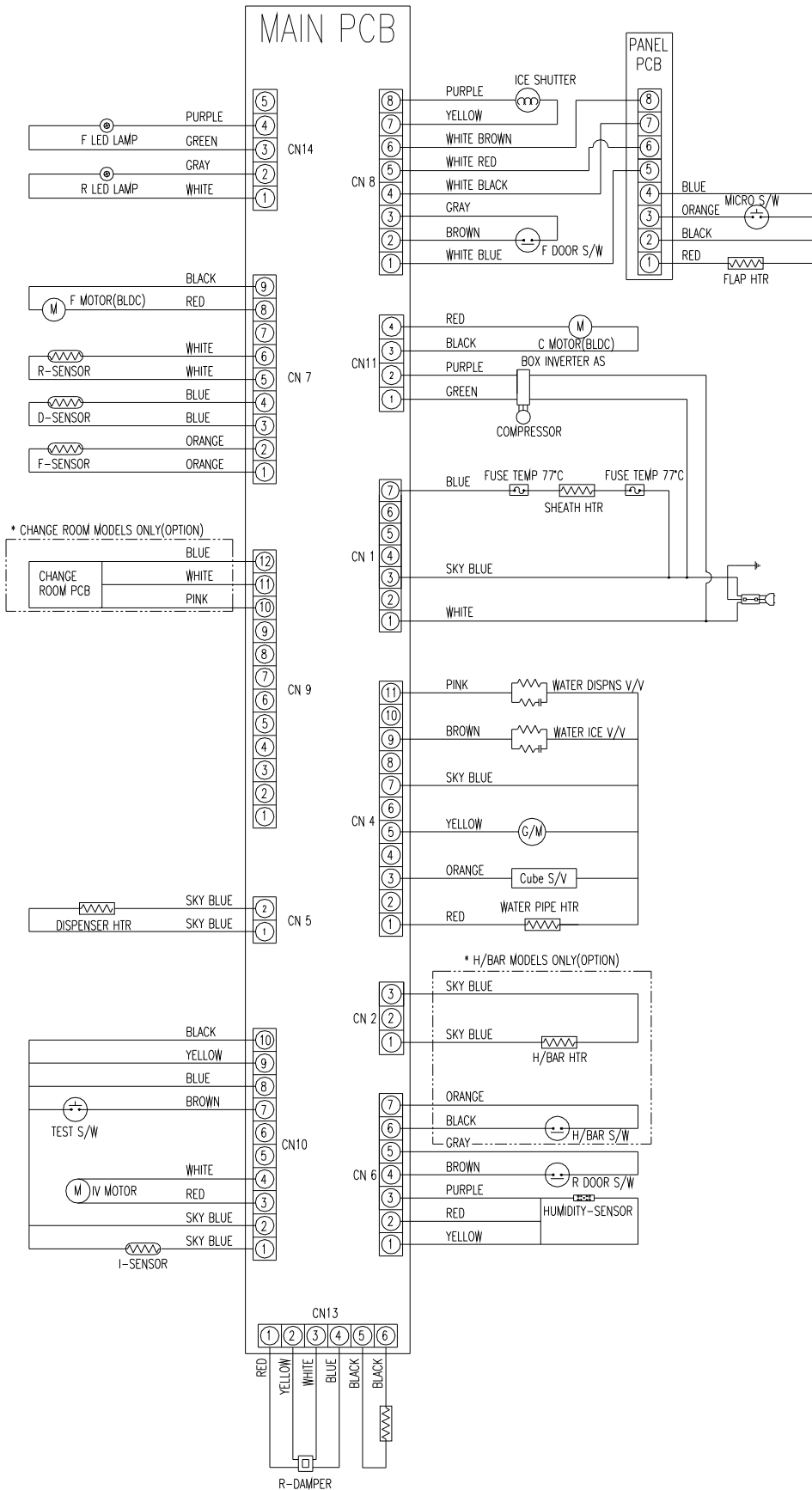

4. External Size and Names of the Refrigerator

4-1. FRQ-19D... (Dispenser only)

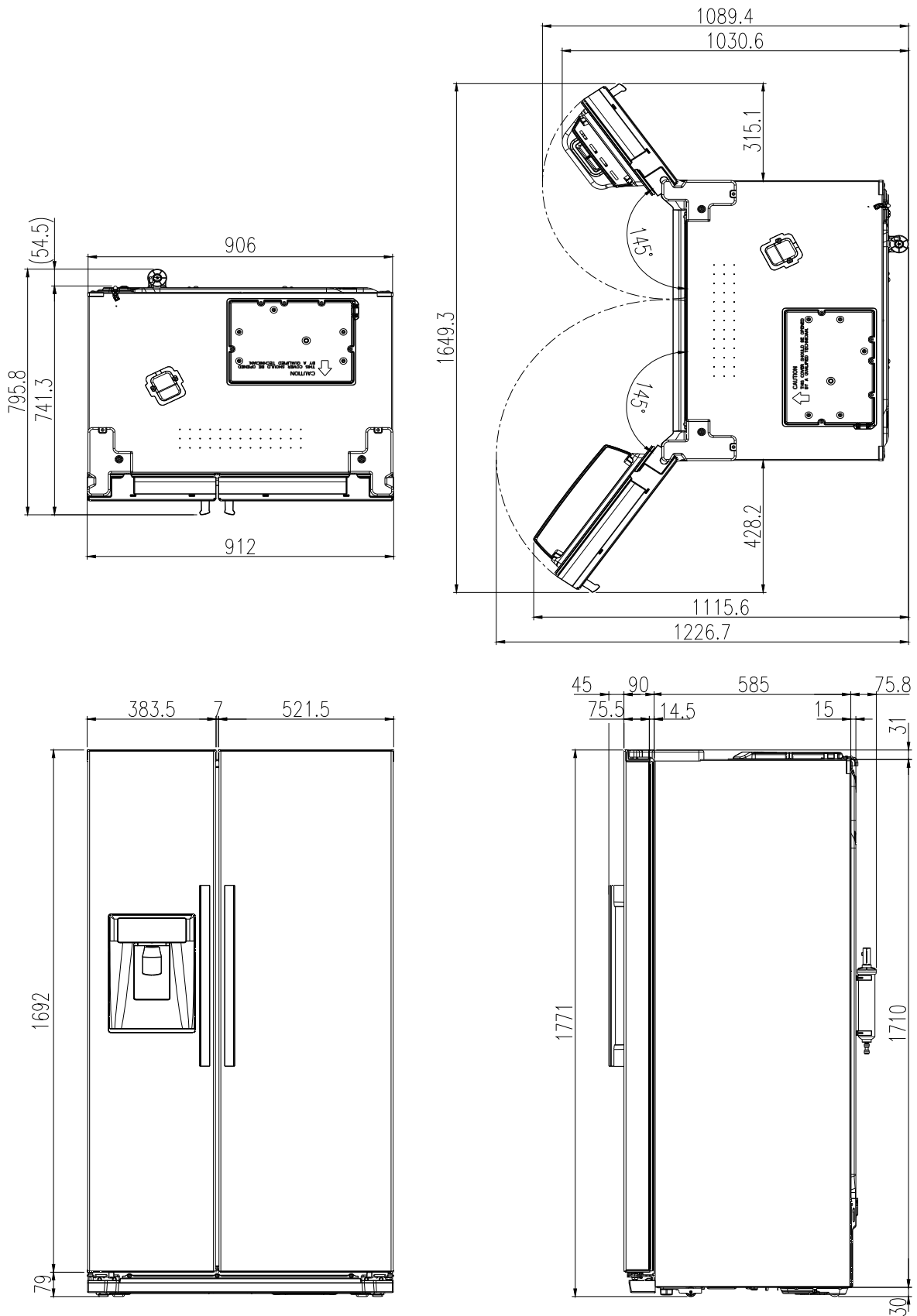

4-2. FRQ-19F... (Dispenser + H/bar)

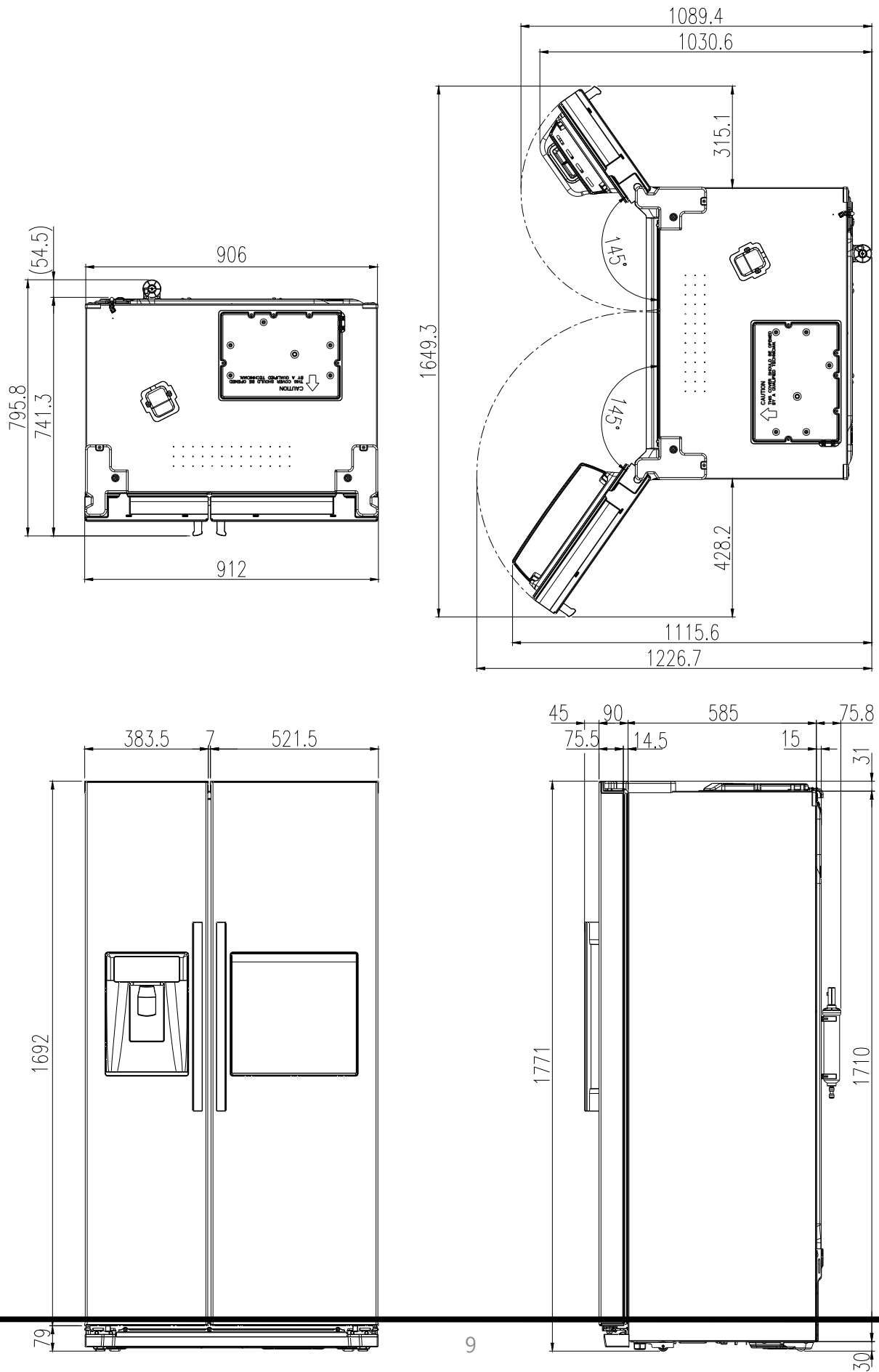

4-3. Part Name (FRQ-19D...)

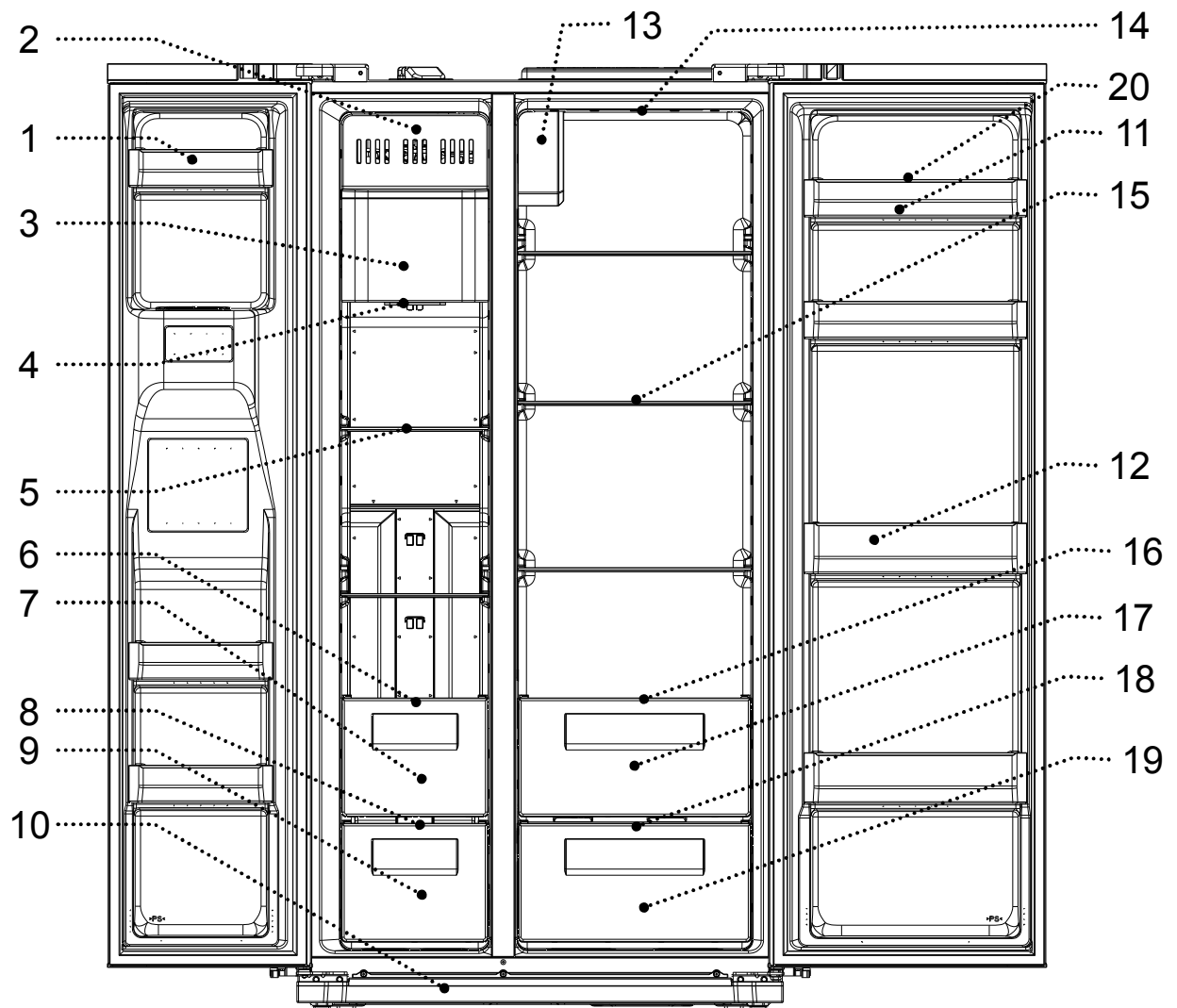

Freezer	Fridge
1. Freezer Pocket	11. Upper Fridge Pocket
2. Upper Ice Crusher Cover	12. Lower Fridge Pocket
3. Lower Ice Crusher Cover	13. Damper Cover
4. Freezer Internal Light	14. Fridge Internal Light
5. Freezer Shelf	15. Fridge Shelf
6. Dried Food Case Cover	16. Upper Vegetable Case Cover
7. Dried Food Case	17. Upper Vegetable Case
8. Meat/Fish Case Cover	18. Lower Vegetable Case Cover
9. Meat/Fish Case	19. Lower Vegetable Case
10. Front Cover	20. Egg Tray

4-4. Part Name (FRQ-19F...)

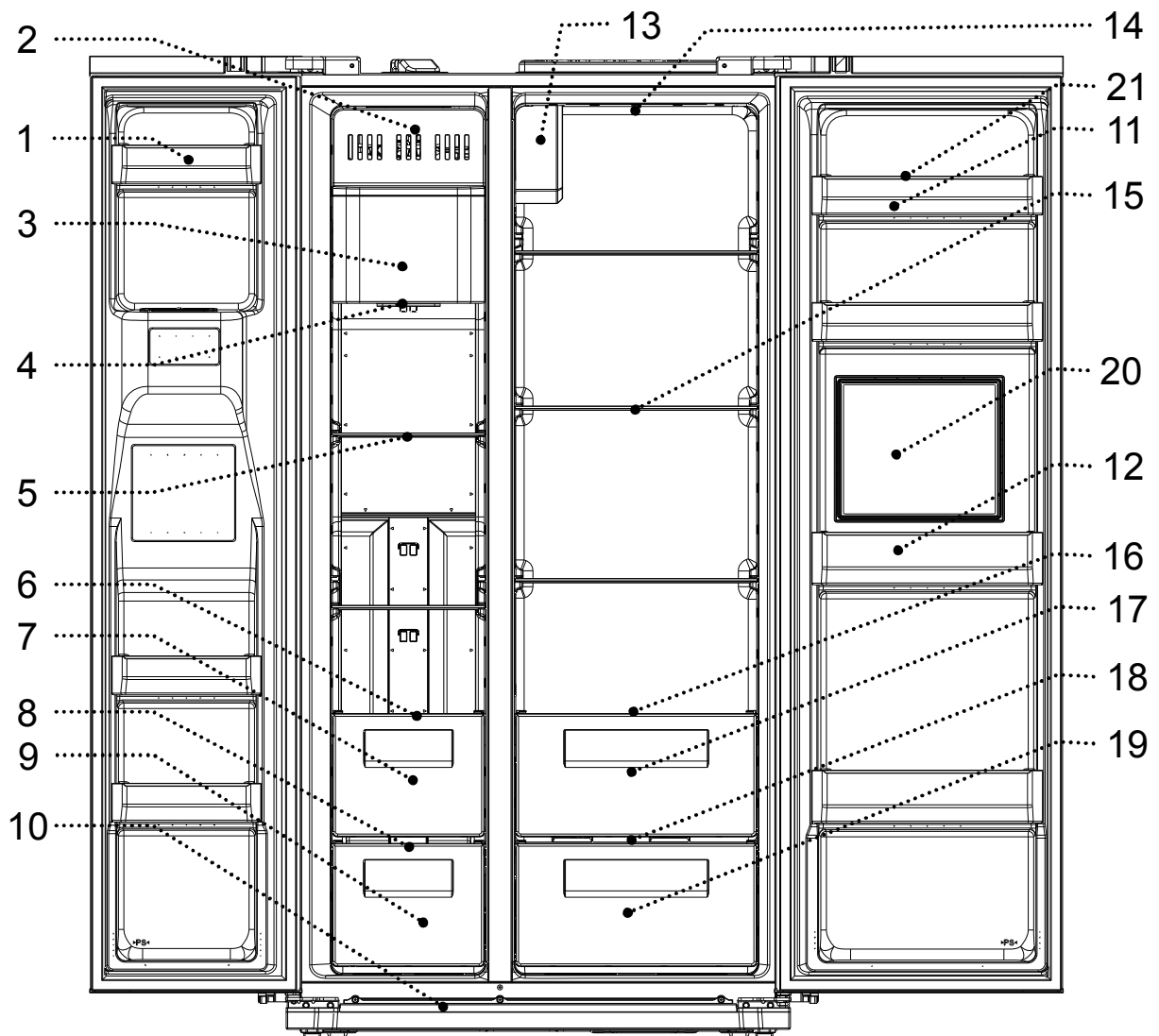

Freezer	Fridge
1. Freezer Pocket	11. Upper Fridge Pocket
2. Upper Ice Crusher Cover	12. Lower Fridge Pocket
3. Lower Ice Crusher Cover	13. Damper Cover
4. Freezer Internal Light	14. Fridge Internal Light
5. Freezer Shelf	15. Fridge Shelf
6. Dried Food Case Cover	16. Upper Vegetable Case Cover
7. Dried Food Case	17. Upper Vegetable Case
8. Meat/Fish Case Cover	18. Lower Vegetable Case Cover
9. Meat/Fish Case	19. Lower Vegetable Case
10. Front Cover	20. Home Bar
	21. Egg Tray

5. Refrigeration Cycle

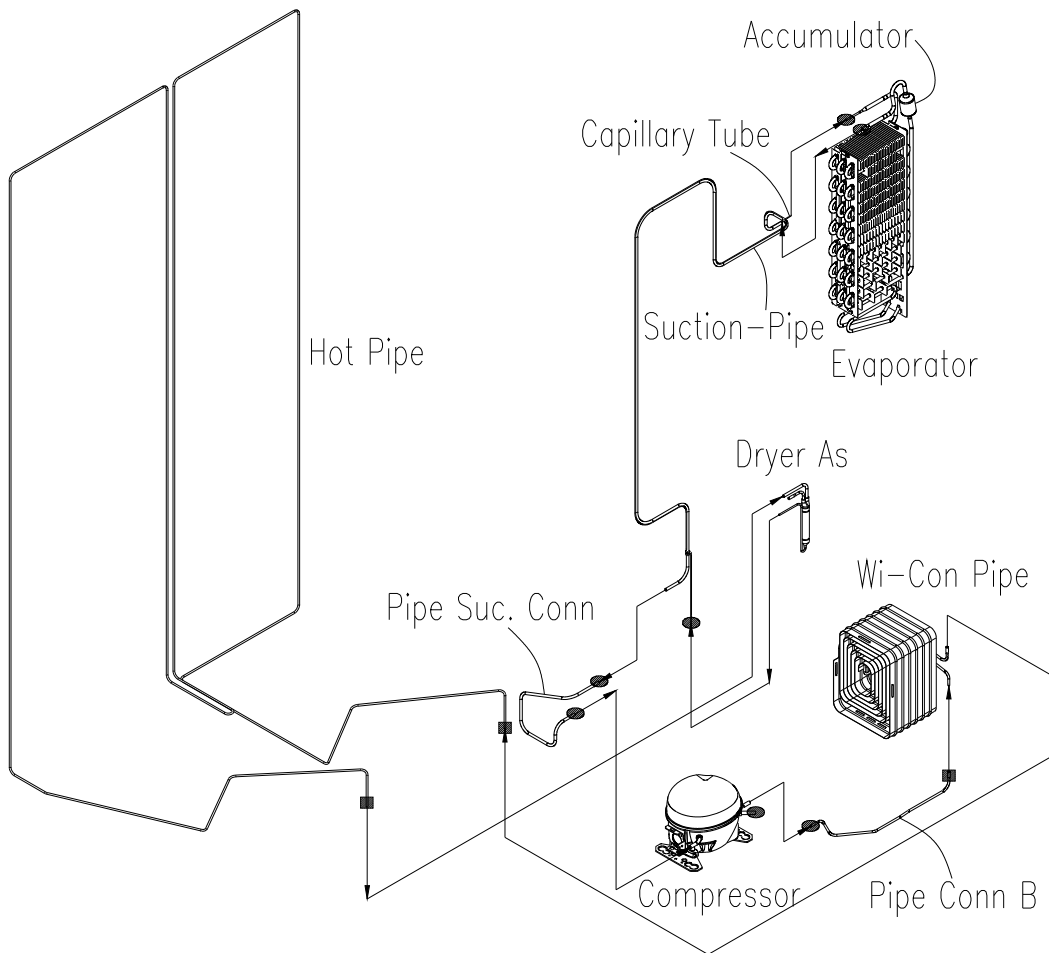

► Welding Specification

●	Copper Soldering (Ag 3%)	7 Points
■	Silver Soldering (Ag 30%)	3 Points

► Refrigerent Flow

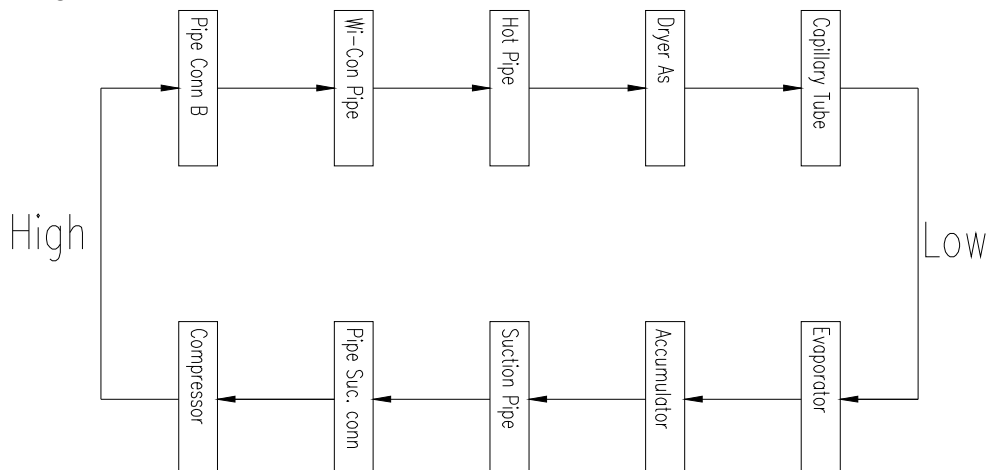

6. Functions & Usage of the Refrigerator

6-1. Display (None crusher model)

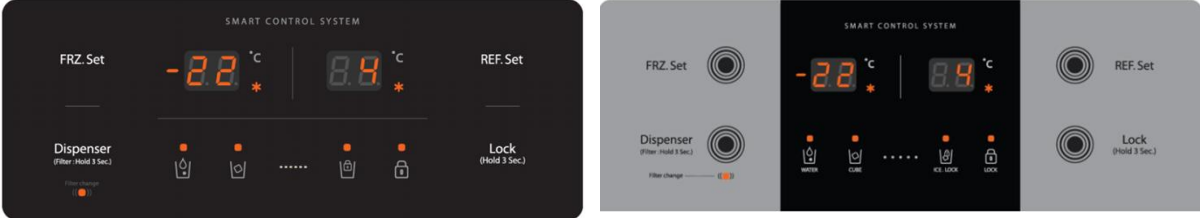
Input Parts	Control Object																		
1. F-PCB Button 2. Freezing Adjustment, Fridge Adjustment 3. lock Button	1. Display																		
Contents																			
																			
<p>1. “Freezing Adjustment” Button</p> <p>1) Press “Freezing Adjustment” Button to have it run in staged temperature adjustment (7 stages) and quick freezing (max. limit 24 hours). In quick freezing running, “ * “ is on; otherwise, it is off.</p> <p>2) Initial default setup at the power connection is “medium” stage, with the setup temperature -19°C displayed. Order of display: Medium(-19°C)→Medium-to-strong1(-20°C)→Medium-to-strong2(-21°C)→Strong(-22°C) →Quick(-22°C)→Weak(-16°C)→Weak-to-medium1(-17°C)→Weak-to-medium2(-18°C)</p> <p>3) When Quick freezing is chosen, “Quick Icon” flickers 6 times before it is lighted, with the setup temperature displayed the same as in dial “Strong”.</p> <p>4) Freezing Adjustment stages & displays</p> <table border="1" data-bbox="248 1406 1337 1518"> <thead> <tr> <th>Adjustment Stages</th> <th>W</th> <th>WM1</th> <th>WM2</th> <th>M</th> <th>MS1</th> <th>MS2</th> <th>S</th> <th>Q</th> </tr> </thead> <tbody> <tr> <td>Setup Temperature($^{\circ}\text{C}$)</td> <td>-16</td> <td>-17</td> <td>-18</td> <td>-19</td> <td>-20</td> <td>-21</td> <td>-22</td> <td>-22</td> </tr> </tbody> </table> <p>5) When Quick freezing is finished, Dial will automatically turn to “Medium(-19°C)”.</p> <p>2. “Fridge Adjustment” Button</p> <p>1) Press “Fridge Adjustment” Button to have it run in staged temperature adjustment (7 stages) and quick fridge(max. limit 40 minutes). In quick freezing running, “ * “ is on; otherwise, it is off.</p> <p>2) Initial default setup at the power connection is “medium” stage, with the setup temperature 2°C displayed. Order of display: Medium(4°C)→Medium-to-strong(3°C)→Strong(2°C)→Quick(2°C)→Weak(8°C)→Weak-to-medium1(7°C) →Weak-to-medium2(6°C)→Weak-to-medium3(5°C)</p> <p>3) When Quick operation is chosen, “Quick Icon” flickers 6 times before it is lighted, with the setup temperature displayed the same as in dial “Strong”.</p>		Adjustment Stages	W	WM1	WM2	M	MS1	MS2	S	Q	Setup Temperature($^{\circ}\text{C}$)	-16	-17	-18	-19	-20	-21	-22	-22
Adjustment Stages	W	WM1	WM2	M	MS1	MS2	S	Q											
Setup Temperature($^{\circ}\text{C}$)	-16	-17	-18	-19	-20	-21	-22	-22											

Contents

2. "Fridge Adjustment" Button

4) Fridge Adjustment stages & displays

Adjustment Stages	W	WM1	WM2	WM3	M	MS	S	Q
Setup Temperature(°C)	8	7	6	5	4	3	2	2

5) When Quick fridge is finished, Dial will automatically turn to "Medium(4°C)".

3. "lock" Function Button

1) lock Setup

- Press "lock" button for 0.5 seconds to have the "lock Icon" On
- When "lock" is set up, no key input (including the dispense switch) is possible nor the buzzer will ring.

2) Cancel: Press the "lock" function button for 3 seconds to cancel the lock state.

4. Power Save Function

All LED will be turned off one minute after a final key input or a door closing (with Lock LED and Water/Ice LED not included).

5. Dispenser select

Led above the icon will light up to indicate your selection.

- 1) 1st 'Dispenser' button, water is available.
- 2) 2nd 'Dispenser' button, cubed ice is available.
- 3) 3rd 'Dispenser' button, dispenser lock.



6-1. Display (Crusher model)

Input Parts	Control Object																		
1. F-PCB Button 2. Freezing Adjustment, Fridge Adjustment 3. lock Button	1. Display																		
Contents																			
																			
<p>1. “Freezing Adjustment” Button</p> <p>1) Press “Freezing Adjustment” Button to have it run in staged temperature adjustment (7 stages) and quick freezing (max. limit 24 hours). In quick freezing running, “ * “ is on; otherwise, it is off.</p> <p>2) Initial default setup at the power connection is “medium” stage, with the setup temperature -19°C displayed. Order of display: Medium(-19°C)→Medium-to-strong1(-20°C)→Medium-to-strong2(-21°C)→Strong(-22°C) →Quick(-22°C)→Weak(-16°C)→Weak-to-medium1(-17°C)→Weak-to-medium2(-18°C)</p> <p>3) When Quick freezing is chosen, “Quick Icon” flickers 6 times before it is lighted, with the setup temperature displayed the same as in dial “Strong”.</p> <p>4) Freezing Adjustment stages & displays</p> <table border="1" data-bbox="247 1406 1337 1518"> <thead> <tr> <th>Adjustment Stages</th> <th>W</th> <th>WM1</th> <th>WM2</th> <th>M</th> <th>MS1</th> <th>MS2</th> <th>S</th> <th>Q</th> </tr> </thead> <tbody> <tr> <td>Setup Temperature($^{\circ}\text{C}$)</td> <td>-16</td> <td>-17</td> <td>-18</td> <td>-19</td> <td>-20</td> <td>-21</td> <td>-22</td> <td>-22</td> </tr> </tbody> </table> <p>5) When Quick freezing is finished, Dial will automatically turn to “Medium(-19°C)”.</p> <p>2. “Fridge Adjustment” Button</p> <p>1) Press “Fridge Adjustment” Button to have it run in staged temperature adjustment (7 stages) and quick fridge(max. limit 40 minutes). In quick freezing running, “ * “ is on; otherwise, it is off.</p> <p>2) Initial default setup at the power connection is “medium” stage, with the setup temperature 2°C displayed. Order of display: Medium(4°C)→Medium-to-strong(3°C)→Strong(2°C)→Quick(2°C)→Weak(8°C)→Weak-to-medium1(7°C) →Weak-to-medium2(6°C)→Weak-to-medium3(5°C)</p> <p>3) When Quick operation is chosen, “Quick Icon” flickers 6 times before it is lighted, with the setup temperature displayed the same as in dial “Strong”.</p>		Adjustment Stages	W	WM1	WM2	M	MS1	MS2	S	Q	Setup Temperature($^{\circ}\text{C}$)	-16	-17	-18	-19	-20	-21	-22	-22
Adjustment Stages	W	WM1	WM2	M	MS1	MS2	S	Q											
Setup Temperature($^{\circ}\text{C}$)	-16	-17	-18	-19	-20	-21	-22	-22											

Contents

2. "Fridge Adjustment" Button

4) Fridge Adjustment stages & displays

Adjustment Stages	W	WM1	WM2	WM3	M	MS	S	Q
Setup Temperature(°C)	8	7	6	5	4	3	2	2

5) When Quick fridge is finished, Dial will automatically turn to "Medium(4°C)".

3. "lock" Function Button

1) lock Setup

- Press "lock" button for 0.5 seconds to have the "lock Icon" On
- When "lock" is set up, no key input (including the dispense switch) is possible nor the buzzer will ring.

2) Cancel: Press the "lock" function button for 3 seconds to cancel the lock state.

4. Power Save Function

All LED will be turned off one minute after a final key input or a door closing (with Lock LED and Water/Ice LED not included).

5. Dispenser select

Led above the icon will light up to indicate your selection.

- 1) 1st 'Dispenser' button, water is available.
- 2) 2nd 'Dispenser' button, cubed ice is available.
- 3) 3rd 'Dispenser' button, crushed ice is available.
- 4) 4th 'Dispenser' button, dispenser lock.



6-2. Freezer Temperature Adjustment

Input Parts	Control Object																								
1. Freezer Temperature Adjustment Button 2. F-Sensor	1. Comp 2. F-Fan																								
Contents																									
<p>1. Press the Freezer button to adjust the Freezer temperature. Medium(-19℃)→Medium-to-strong1(-20℃)→Medium-to-strong2(-21℃)→Strong(-22℃) →Quick(-22℃)→Weak(-16℃)→Weak-to-medium1(-17℃)→Weak-to-medium2(-18℃)</p> <p>2. Comp and F-fan are controlled by Dial On / Off.</p> <p>3. On / Off Diff of the Freezer: 4.0℃ Medium Off point of the Freezer : -20.8℃</p> <p>4. Freezer Diff for each step</p> <ol style="list-style-type: none"> 1) Weak → Weak-to-medium1 : 3.0 deg. 2) Weak-to-medium1 → Weak-to-medium2 → Medium : 1.0 deg. 3) Medium → Medium-to-strong1 : 0.6 deg. 4) Medium-to-strong1 → Medium-to-strong2 : 1.4 deg. 5) Medium-to-strong2 → Strong : 3.0 deg. <p>5. Control Point for each Dial (F-Sensor Detection Temperature)</p>																									
<table border="1" style="margin: auto;"> <caption>Freezer Temperature Control Points</caption> <thead> <tr> <th>MODE</th> <th>ON Point (℃)</th> <th>OFF Point (℃)</th> </tr> </thead> <tbody> <tr> <td>Weak</td> <td>-8.8</td> <td>-13.3</td> </tr> <tr> <td>(Weak to medium1,2)</td> <td>-12.0</td> <td>-16.3</td> </tr> <tr> <td>Medium</td> <td>-13.1</td> <td>-17.2</td> </tr> <tr> <td>(Medium to strong1,2)</td> <td>-14.1</td> <td>-18.2</td> </tr> <tr> <td>Strong</td> <td>-15.1</td> <td>-19.1</td> </tr> <tr> <td>Strong</td> <td>-17.0</td> <td>-20.9</td> </tr> <tr> <td>Strong</td> <td>-18.9</td> <td>-22.8</td> </tr> </tbody> </table>		MODE	ON Point (℃)	OFF Point (℃)	Weak	-8.8	-13.3	(Weak to medium1,2)	-12.0	-16.3	Medium	-13.1	-17.2	(Medium to strong1,2)	-14.1	-18.2	Strong	-15.1	-19.1	Strong	-17.0	-20.9	Strong	-18.9	-22.8
MODE	ON Point (℃)	OFF Point (℃)																							
Weak	-8.8	-13.3																							
(Weak to medium1,2)	-12.0	-16.3																							
Medium	-13.1	-17.2																							
(Medium to strong1,2)	-14.1	-18.2																							
Strong	-15.1	-19.1																							
Strong	-17.0	-20.9																							
Strong	-18.9	-22.8																							
<p>6. Quick Freezing</p> <ol style="list-style-type: none"> 1) In Quick Freezing, it is run by 'Strong' dial of F-Dial for the limited time(24 hours). 2) When Quick Freezing is closed by the time limit or the F-Sensor is Off point, it is run with the 'Medium' dial value of the F-Dial. 3) During a Quick Freezing operation, defrosting cannot be started. If Quick Freezing is set up in defrosting, Quick Freezing will be run after the defrosting. 																									

6-3. Fridge Temperature Adjustment

Input Parts	Control Object
1. Fridge Temperature Adjustment Button 2. R-Sensor	1. Comp 2. F-Fan 3. Damper

Contents

1. Press the Freezer button to adjust the setup temperature of the Freezer.
 Medium(4°C)→Medium-to-strong(3°C)→Strong(2°C)→Quick(2°C)→Weak(8°C)→Weak-to-medium1(7°C)→Weak-to-medium2(6°C)→Weak-to-medium3(5°C)
2. Comp and F-fan are controlled by the On / Off points of each Dial.
3. On / Off Diff of the Fridge: 0.5°C
 Fridge "Medium" Off point: 5.5°C
4. Fridge Step Diff
 - 1) Each Step Diff: 1 deg.
 (At low room temperature (RT-S of 19°C or less), Dial 'Medium, Medium-to-strong, Strong' will lower the On/Off points by 1°C, while at high room temperature (RT-S of 41°C or more), Dial 'Medium, Medium-to-strong, Strong' will lower the On/Off points by 0.3°C.)
5. Prevention of Weak Cooling
 - 1) When Weak Cooling is detected, Comp is turned on, regardless of F-Sensor.
 - 2) When R-sensor reaches R-Damper Close point, Comp is controlled by the F-sensor and R-Damper is Close.
 - 3) Weak Cooling detection point: R-Damper Close of each Mode + 7°C
 - 4) Weak Cooling cancellation point: the same as the R-Damper Close point of each Mode
6. Control Point for each Dial (R-Sensor detection temperature)

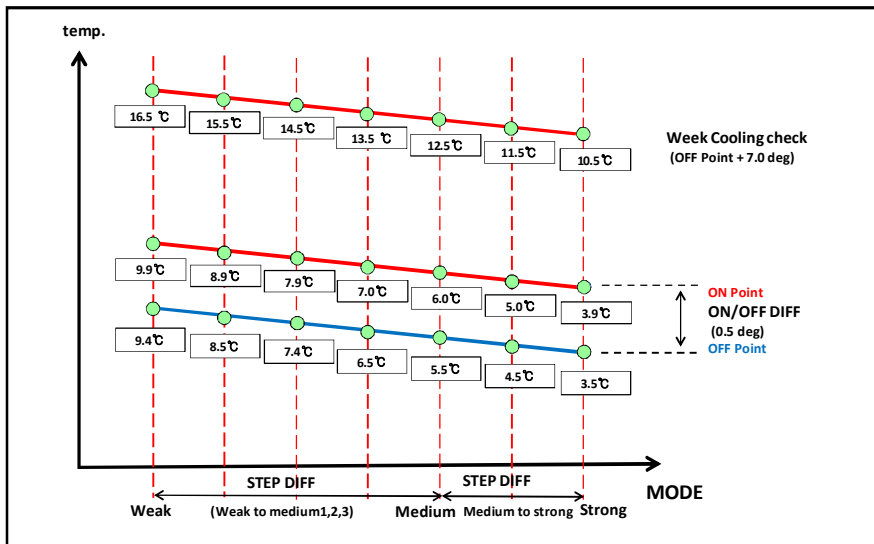

7. Quick Fridge
 - 1) In Quick Fridge, it is run in 'Strong' dial of the R-Dial for the limited time (40 minutes).
 - 2) Until the R-sensor reaches the Overcooling Off point(-7deg.), R-Damper is open and F-Fan / Comp are On.
 - 3) After the Overheating Off point is reached, it is run by Dial "strong" On/Off points until 40 minutes of Quick Fridge is finished.
 - 4) When the Quick Fridge is finished, it will turn to normal operation.

6-4. Fan Control at each Mode

Input Parts		Control Object			
1. R-Sensor 2. F-Sensor		1. F-Fan 2. C-Fan			
Contents					
1. Fan RPM for each control Mode					
1) F-Fan Motor voltage					
Control Mode	Normal	Quick Freezing	Load Response1	Load Response2	RT-S 39°C or more
F-FAN voltage	10V	12V	12V	13V	13V
<ul style="list-style-type: none"> ● Normal Control ☞ Low operation mode with soft noise ● Load Response ☞ Operation mode when the temperature in the compartments is deemed escalating by usage condition. 					
2. Load Response Mode					
1) Purpose: To recover the temperature of the compartment escalated by overload or an opening of the door.					
2) Display Method: There is no separate display.					
3) Conditions for Load Response1 startup and cancellation, and its control method					
	Freezer Load Response		Fridge Load Response		
Startup Condition	1. F/R-Door opening of 30 seconds or more				
	2. F/S On Point + 5deg. or more detected		2. R/S On Point + 5deg. or more detected		
Cancel. Condition	F-Sensor value < Off point		R-Sensor value < Off point		
Control Method	Comp RPM is controlled to change to the next higher stage of RPM				
4) Conditions for Load Response2 startup and cancellation, and its control method					
	Freezer Load Response		Fridge Load Response		
Startup Condition	1. Load Response1 at RT-S 29 °C or less				
	2. When COMP has continuously operated for 6 hours				
Cancel. Condition	Cancelled if the defrosting is started				
Control Method	Operation with Comp RPM being 3990				

6-5. Defrosting

Input Parts	Control Object																									
1. Accumulated Comp Operation Time 2. Time Lapse since a Comp On/Off	1. Comp 2. F-Fan 3. Defrosting Heater 4. Damper																									
Contents																										
<p>1. Defrosting Startup Condition</p> <p>1) Accumulated Comp Operation Time: If it passes 8,10,12,~ 40 hours and, at the same time, various errors take place or the accumulated F-Door Opening is 2 minutes or more, the defrosting will be started.</p> <p>2) If the accumulated F/R-Door Opening time is 2 minutes or more and the operation rate in 2 hours is 85% or more, the defrosting will be started.</p> <p>3) Total (Comp On Time + Comp Off Time) time : If it is 50 hours, the defrosting will be started.</p> <p>4) If accumulate Comp operation time is 24 hours, the defrosting will be started.</p> <p>* Various Errors : R1, F1, D1, F3, RT/S, C1, Door error.</p> <p>2. General Defrosting Procedure</p> <div style="display: flex; align-items: flex-start;"> <div style="flex: 1;"> <pre> graph TD A[Precool] --> B[Heater Defrosting] B --> C[Pause] C --> D[Fan Delay] </pre> </div> <div style="flex: 2;"> <p>1) Time limit is 50 minutes (Comp, F-fan operation)</p> <p>2) When the lime limit of 50 minutes passes, F-Sensor < -27°C, or there is Error F3, Precool will end.</p> <p>* There is no Precool in a general Defrosting (but only in a power consuming mode).</p> <p>1) When D-Sensor $\geq 13^{\circ}\text{C}$, Defrosting Heater will be Off.</p> <p>2) When the Defrosting heater turns off by the time limit (60 minutes), there will be an F3-Error.</p> <p>3) If there is a D-Sensor Error, the Defrosting Heater will be on, with the time limit of 30 min.</p> <p>4) Process Time Limit</p> <p style="margin-left: 20px;">① 30min.: At a D-Error, each heater is on for 30/10 min.</p> <p style="margin-left: 20px;">② 60min.: When defrosting starts at a normal control state, the time limit will be 60min.</p> <p>1) Pause Time = 10min.</p> <p>2) In the pause time, Defrosting Heater, Comp and F-Fan is off.</p> <p>3) During the pause time, Comp is off regardless of the R-Sensor temperature.</p> <p>1) Fan Delay Time = 5min.</p> <p>2) Immediately after the pause, only the Comp is on, with the Heater off.</p> </div> </div> <p>3. Power consuming mode starting (Average operation rate before a Defrosting is 80% or less)</p> <p>1) If D-Sensor $\geq 9^{\circ}\text{C}$, the Defrosting Heater will be off.</p> <p>2) Pause time is 10min.</p> <p>3) After a Precool mode is proceeded, Heater-on mode will start.</p> <p>4. Electronic Unit Control State & Time Limit for Each Mode</p> <table border="1" style="width: 100%; border-collapse: collapse; text-align: center;"> <thead> <tr> <th></th> <th>Precool</th> <th>D-HTR Defrosting</th> <th>Pause</th> <th>Fan Delay</th> </tr> </thead> <tbody> <tr> <td>Comp</td> <td>On</td> <td>Off</td> <td>Off</td> <td>On/Off</td> </tr> <tr> <td>F-Fan</td> <td>On</td> <td>Off</td> <td>Off</td> <td>Off</td> </tr> <tr> <td>D-HTR</td> <td>Off</td> <td>On</td> <td>Off</td> <td>Off</td> </tr> <tr> <td>Time Limit</td> <td>50min.</td> <td>60min.</td> <td>10min.</td> <td>5min.</td> </tr> </tbody> </table>			Precool	D-HTR Defrosting	Pause	Fan Delay	Comp	On	Off	Off	On/Off	F-Fan	On	Off	Off	Off	D-HTR	Off	On	Off	Off	Time Limit	50min.	60min.	10min.	5min.
	Precool	D-HTR Defrosting	Pause	Fan Delay																						
Comp	On	Off	Off	On/Off																						
F-Fan	On	Off	Off	Off																						
D-HTR	Off	On	Off	Off																						
Time Limit	50min.	60min.	10min.	5min.																						

5. Defrosting Flow Decision

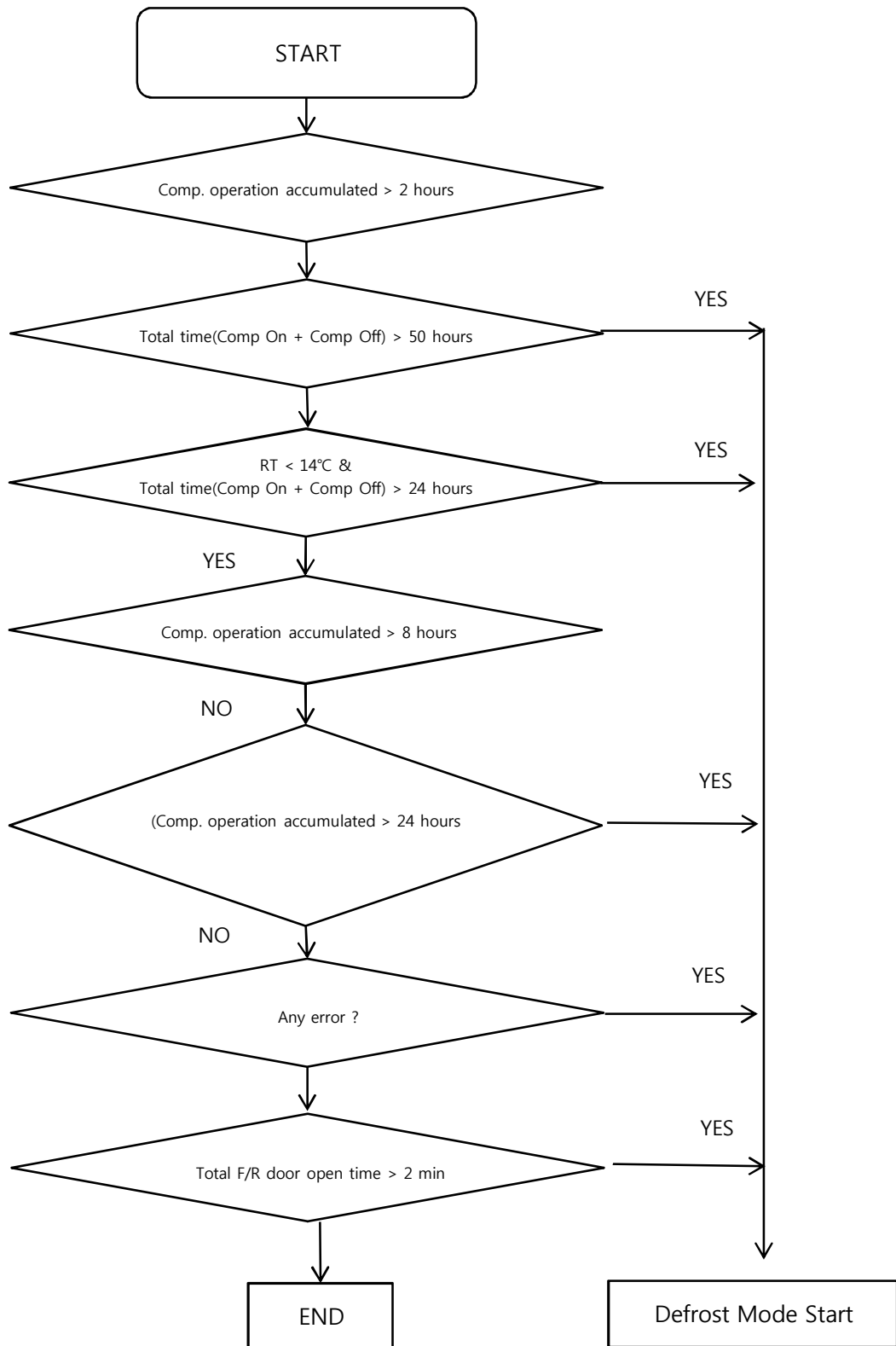

6-6 Initial Defrosting

Input Parts	Control Object
1. D-Sensor 2. Initial Power Supply	1. Defrosting Mode
Contents	
1. If D-Sensor $\leq 3.5^{\circ}\text{C}$ when the initial power supply begins, Defrosting mode will start. 2. Defrosting is made per D-Sensor. 3. When in initial Defrosting, Comp is delayed by 6min.	

6-7 Short Circuit Operation

Input Parts	Control Object
1. Front PCB	1. Electronic Units
Contents	
1. Starting: Press "Fridge Adjustment" + "Freezing Adjustment" 10 times in the "Locked" state. 2. Control Method: Comp & F/C-Fan continuous operation. R Damper Open 3. Operation Display: "Co" displayed at Error Display Mode (Refer to Error Display) 4. Cancellation: Automatically canceled 10 hr after starting	

6-8. Comp RPM Control (Inverter compressor model only)

Input Parts	Control Object			
N/A	1. Comp			
Contents				
1. Comp RPM is changed per RT-Sensor & Set operation state				
Temperature Condition	~29℃	29℃ ~ 35℃	35℃ ~ 41℃	41℃ ~
Normal Operation	1800 RPM	2550 RPM	3600 RPM	3990 RPM
Load Response1	2550 RPM	3600 RPM	3990 RPM	3990 RPM
Load Response2	3990 RPM	3990 RPM	3990 RPM	3990 RPM
Quick Operation	3600 RPM	3600 RPM	3600 RPM	3990 RPM
Short Circuit Operation	3990 RPM	3990 RPM	3990 RPM	3990 RPM
2. For 5 min. after an initial power supply, 1800RPM (lowest speed) operation				

6-9. Prevention of Comp Re-start

Input Parts	Control Object
N/A	1.Comp
Contents	
<p>1. For 6 min. after Comp is off, it will not re-start even though there is a Comp On condition occurring.</p>	

6-10. Time Shortening Function

Input Parts	Control Object
1. Main PCB	1. Electronic Units
Contents	
<p>1. 1 min. Shortening: Click "Fast Key" of Main PCB.</p> <p>2. 30 min. Shortening: Press "Fast Key" continuously and it will be shortened by 30 min. every 2.5 seconds with a short buzzer beeping.</p> <p>3. Usage Example: May be used to shorten unnecessary time. (6 min. Pause function, Fan Delay function)</p>	

6-11. Buzzer Function

Input Parts	Control Object
<p>1. Front PCB Button</p> <p>2. Door Switch</p> <p>3. Initial Power Supply</p>	1. Buzzer
Contents	
<p>1. Buzzer beeps as Front PCB is manipulated.</p> <p>2. Buzzer beeps 3 sec. after an initial power supply.</p> <p>3. Buzzer beeps at a power consuming mode forced Defrosting, short-circuit operation, A/S forced Defrosting.</p> <p>4. Buzzer beeps when you press a button as you are fine-tuning the Freezer / Fridge.</p> <p>5. Buzzer beeps every minute when a Door is open (for 5 min.).</p>	

6-12. Electronic Unit Delay Time

Input Parts	Control Object
1.Comp On / Off	1.Comp 2.F/C-Fan
Contents	
<p>1. Comp / C-Fan / F-Fan</p> <p>1) F-Fan Time Delay function at Comp On/Off (F-FAN on/off 1 min. after Comp on/off).</p> <div data-bbox="244 600 1137 952" data-label="Diagram"> </div> <p>2) C-Fan : On 0.5 sec. after an On condition occurring</p> <p>3) F-Fan : On 1.0 sec. after an On condition occurring</p> <div data-bbox="244 1151 1011 1655" data-label="Diagram"> </div>	

6-13. Internal Light Control Function

Input Parts	Control Object
1. F Door 2. R Door 3. Home bar Door (option)	1. F/R Compartment Lights
Contents	
<p>1. R Compartment Light Control</p> <ol style="list-style-type: none"> 1) R Compartment Light is on/off immediately after a R Door Switch Open / Close signal detection. 2) But if opened state continues for 10 min. after a R Door Switch detects Opening, R Compartment light will turn off even though there is no Close signal detected. 3) When opening is detected continuously for 1 hr. or more, “dr” Error is displayed and the functions related to the Door Switch detection will be ignored. <p>2. F Compartment Light Control</p> <ol style="list-style-type: none"> 1) F Compartment Light is on/off immediately after a F Door Switch Open / Close signal detection. 2) But if opened state continues for 10 min. after a F Door Switch detects Opening, F Compartment light will turn off even though there is no Close signal detected. 3) When opening is detected continuously for 1 hr. or more, “dF” Error is displayed and the functions related to the Door Switch detection will be ignored. <p>3. R Compartment Light Control by Home Bar</p> <ol style="list-style-type: none"> 1) R Compartment Light will be on/off immediately after a Home bar Door Switch Open/Close signal detection. 2) But if opened state continues for 10 min. after a Home bar Door Switch detects Opening, R Compartment light will turn off even though there is no Close signal detected. 3) When opening is detected continuously for 1 hr. or more, “dH” Error is displayed and the functions related to the Door Switch detection will be ignored. 	

6-14. DEMO Function

Input Parts	Control Object
1. Fridge Button 2. Freezer Button	1. Comp 2. F-Fan 3. Heater
Contents	
<p>1. Starting Press "fridge adjustment" button at the "Locked State" and press "Choose Freezing" 5 times.</p> <p>2. Control Method</p> <p>1) Electronic units will all be off.</p> <p>2) But if the Freezer and Fridge doors are open, the pertinent Fan will be on. Door Open → Fan On , Door Close → Fan Off</p> <p>3) Display Freezing and Fridge temperature Display for each stage → Quick Icon On → Water Icon On → Cube Icon On → Ice Maker Lock Icon</p> <p>3. Cancellation</p> <p>1) Press Fridge Adjustment + Choose Freezing 5 times.</p> <p>2) Reset Power Supply.</p>	

6-15. Weak Cooling Option

Input Parts	Control Object
1. J1, J2 on the Main PCB	1. R-Sensor "Medium" Off Point Standard Resistance
Contents	
<p>1. R-Sensor Off Point Adjustment (Maximum 3°C down)</p> <p>2. When weak cooling occurs, adjustment is made as following so as to make A/S easy.</p> <p>1) Resistance(R36) : R-Sensor Standard Resistance at normal operation (31.4K)</p> <p>2) Resistance(R37) : Standard Resistance 2K up by J1 cutting at weak cooling (1.5°C down)</p> <p>3) Resistance(R38) : Standard Resistance 4K up by J1 & J2 cutting at weak cooling (3.0°C down)</p> <div style="display: flex; align-items: flex-start;"> <div style="flex: 1;"> <p>The diagram shows an R-SENSOR connected to a node. From this node, a resistor R36 is connected to ground. Another branch from the node goes through resistor R37 to ground, controlled by J1. A third branch goes through resistor R37 and then resistor R38 to ground, controlled by J1 and J2.</p> </div> <div style="flex: 1; margin-left: 20px;"> <p>R36 = Medium OFF Point R36 + R37 = Medium OFF Point - 1.5 deg. R36 + R37 + R38 = Medium OFF Point - 3.0 deg.</p> </div> </div>	

6-16. Automatic Ice Machine

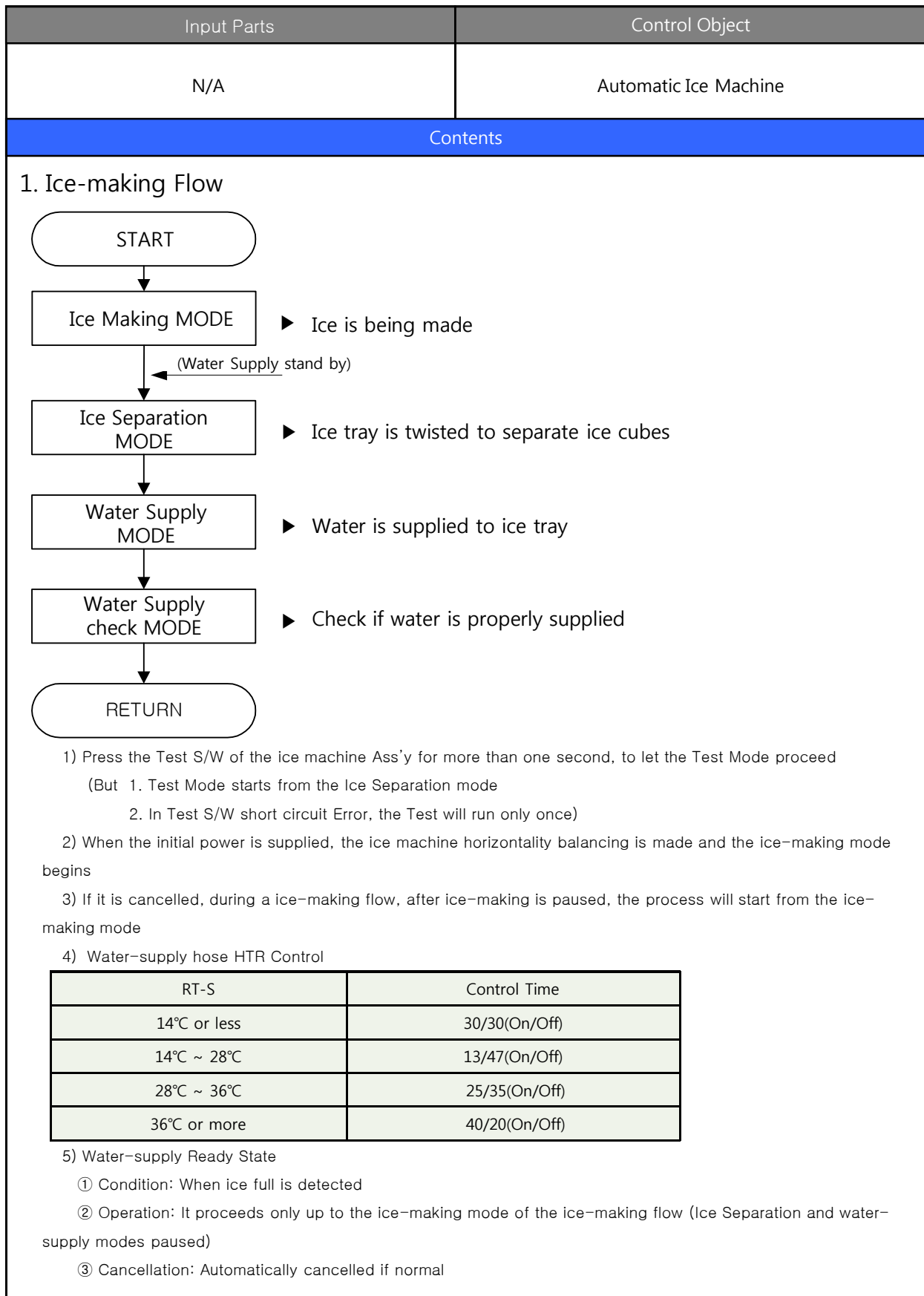

2. Ice-making Mode

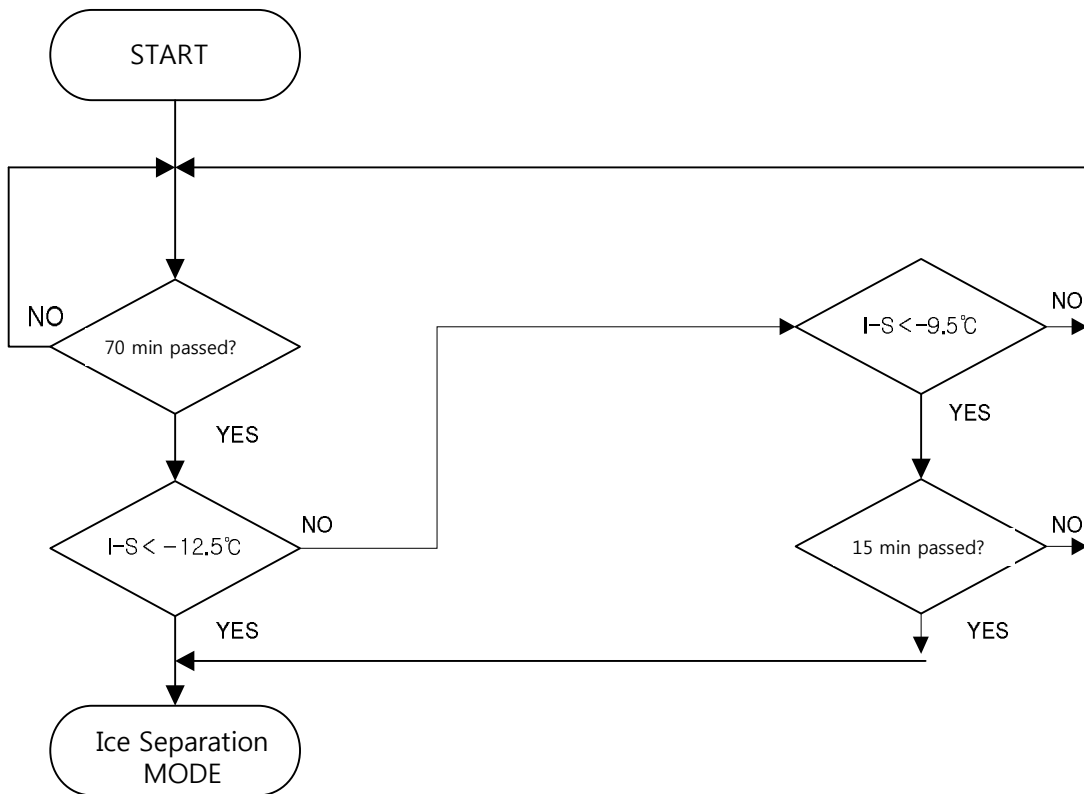

- 1) If I-S is -12.5°C or lower after 70 min. lapsing, ice making is finished
- 2) If I-S is higher than -12.5°C after 70 min. lapsing but it continuously maintains -9.5°C or lower for 15 min, ice making is finished
- 3) If there is an I-Sensor Error, ice making is finished after 4.8hr lapsing

3. Ice Separation Mode

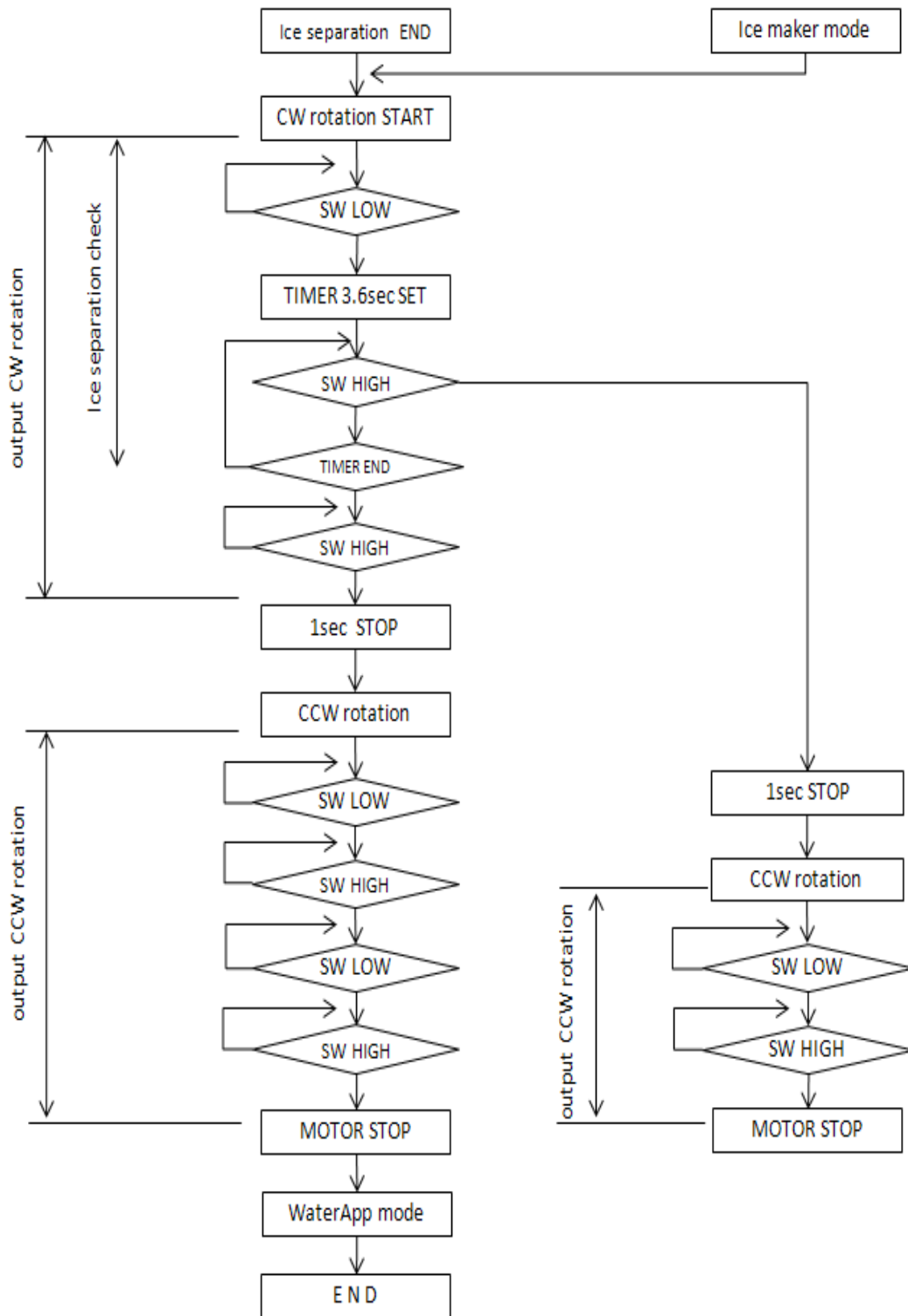

4. Water-supply Mode

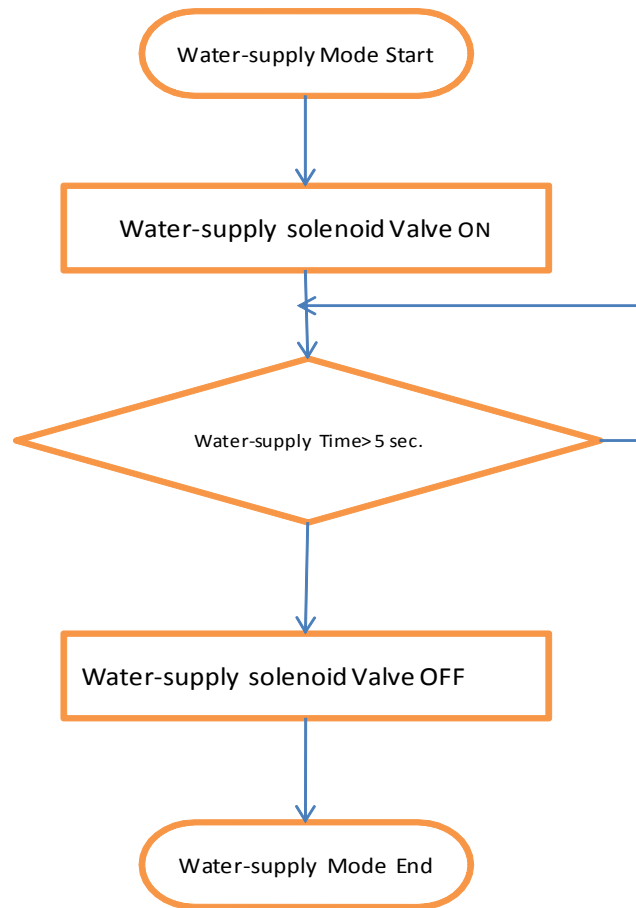

- 1) If Water-supply mode starts after an Ice Separation, the solenoid valve will be on.
- 2) Water-supply is made by time: Normal supplying time 5 sec.
- 3) How to adjust the Water-supply time
 - (a) Starting of the Adjustment 1:
 - (LOCKED State) Press Dispenser Button for 10 sec. to see P0 05 displayed
 - (b) Starting of the Adjustment 2:
 - Press Freezer Button + Dispenser Button 5 times: Error Display Mode started
 - Press Freezer Button 5 times: Initially setup Water-supply time P0 05 is displayed at 88 segment (Meaning 5 sec.)
 - (c) If you press Dispenser once, P0 05 is displayed (Meaning 5 sec.)
 - (d) Water-supply time may be up to 22 sec. -> Next to P0 22, P0 03 is set (Minimum supplying time is 3 sec.)
 - (Water-supply time 3~10sec. -> Time increases by one sec. for each Dispenser pressing
 - Water-supply time 10~22sec. -> Time increases by two sec. for each Dispenser pressing)

5. Water-supply Check Mode

-Water-supply is checked by the I-S temperature detected in accordance with the RT-S temperature mode after Water-supply

RT	7℃↓	~13℃	~19℃	~29℃	~39℃	39℃↑
RT-S	8℃↓	14℃	~20℃	~30℃	~42℃	42℃↑
I-S	-11.5℃	-10.5℃	-9.5℃	-8.5℃	-7.5℃	-6.5℃

6. Water-supply Error Operation Mode

1) Water-supply Error Operation Mode starts when Water-supply error continually takes place 3 times

① At an I-S temperature escalation error after a Water-supply

* For each Water-supply error, Water-supply hose HTR runs for 60 min.

* When Water-supply error is detected once, it is displayed on the Error Display

2) Water-supply error mode (ice-making pause and full-ice state included) operation

① Ice Separation & Water-supply are paused

3) Control method of the Water-supply heater (Cases of Water-supply error, Ice-making pause and full ice included)

Humidity 60% ↓	Full-ice Lever Down(Normal)	RT Condition at Water-supply
	Full-ice Lever Down(Water-supply error state)	Water-supply HTR Linked to Defrosting after 3 times of error checking
	Full-ice Lever UP	Water-supply HTR Linked to Defrosting
	ICE LOCK	Water-supply HTR Linked to Defrosting
Humidity 60% ↑	Full-ice Lever Down(Normal)	RT Condition at Water-supply
	Full-ice Lever Down(Water-supply error state)	RT Condition at Water-supply after 3 times of error checking
	Full-ice Lever UP	RT Condition at Water-supply
	ICE LOCK	RT Condition at Water-supply

- In case water is supplied, as a full ice is cancelled

→ Water-supply starts after 10 min. of Water-supply HTR operation, after ice machine Ice Separation operation is finished, before the Water-supply is started

- In case water is supplied once first, after ICE LOCK is cancelled

→ Water-supply starts after 10 min. of Water-supply HTR operation, after ice machine Ice Separation operation is finished, before the Water-supply is started

4) Cancellation: Manipulate the Dispenser switch once

(At the mode cancellation, Water-supply hose HTR runs for 60 min. and then ice removal and Water-supply start)

7. Dispenser Function

1) Water/Ice Choice Button

- ① Normal Default Mode is Water.
- ② When Water/Ice Button is pressed, the pertinent Icon will be On and the other ones will be off.
- ③ When the dispense switch is pressed, the pertinent water / ice cube will be discharged in accordance with the chosen mode.

2) Ice-making Pause Button

- ① If you choose the Ice-making Pause mode after pressing the dispenser choice, Ice-making Pause function and LED will be On/Off.

3) Display

- ① Normal Default Mode is water LED On.
- ② When Water / Ice Cube is chosen, the pertinent LED will be lighted.
(But if Disp S/W Error takes place at pertinent Water / Ice Cube operation, the pertinent LED will be flickered.)

4) Control Flow & Timing Chart

① When Ice Cube is chosen

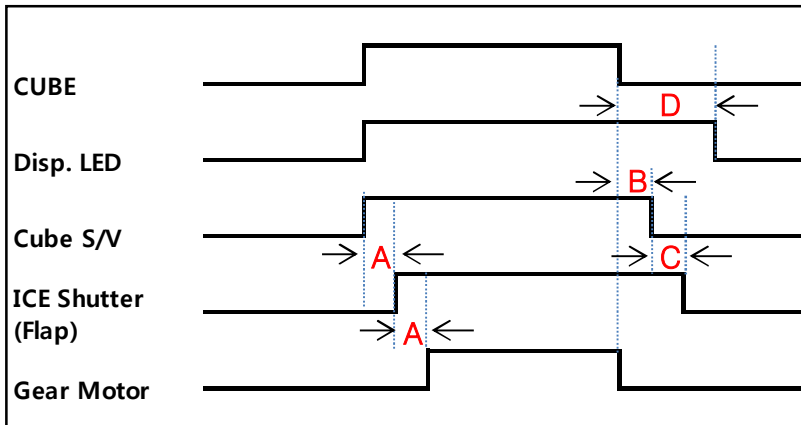

② When Water is Chosen

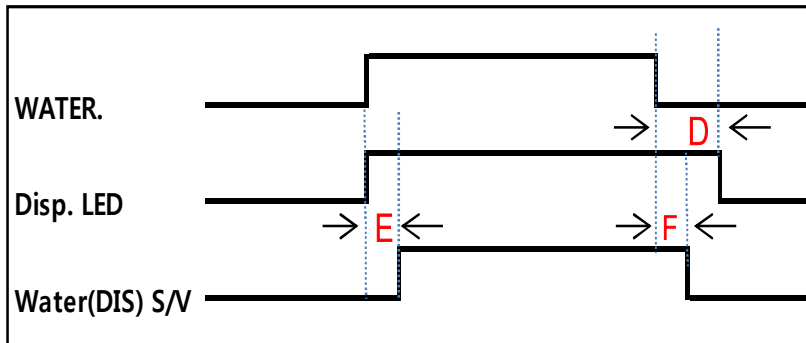

DELAY TIME : A = 0.5s, B = 0.5s, C = 2.0s, D = 5.0s, E = 0.5s, F = 0.5s

6-17. Error Display & Control Method

Input Parts	Control Object	
1. Freezer Button 2. lock Setup Button	1.FCP LED	
Contents		
<p>1. Starting: At a "Locked" state, press "Lock Setup" 5 times while "Freezer" Button is pressed.</p> <p>2. Display: The Code for the Error is Displayed using 88 Segment.</p> <p>3. Cancellation: Press "Lock Function" once.</p> <p>4. Automatic cancellation: In 4 min. after the starting, it is automatically cancelled.</p> <p>5. All Error Codes will reset, when it turns to normal state.</p> <p>6. Error Code Display</p>		
Error Code	내 용	
F1	F-Sensor Disconnection, Short Circuit	At Temperature Display, a Disconnection is shown as "Lo", Short Circuit "Hi"
r1	R-Sensor Disconnection, Short Circuit	
rt	RT-Sensor Disconnection, Short Circuit	
d1	D-Sensor Disconnection, Short Circuit	
HS	Humidity Sensor Disconnection, Short Circuit	
dr	When R-Door Open is detected for one hr. or longer	
dF	When F-Door Open is detected for one hr. or longer	
dH	When home-bar Door Open is detected for one hr. or longer	
C1	When Comp has run 3 hr. or longer as D Sensor detects -5℃ or higher	
EP	At a EEPROM Read/Write Error	
D2	At A/S forced Mode (≡ ≡ d2 displayed)	
CE	For the Front, no Data from RX for 30 sec.	
CE	For the Main, no Data from RX for 30 sec.	
d3	At Power consuming forced defrosting	
F3	When returning from defrosting by the time limit of 50 min. due to D-Sensor	
Ei	At I-Sensor Disconnection / Short Circuit	
Eg	When I-Sensor Temperature does not go up to a certain point after a water supply	

Contents

7. Control Method (At an Error Occurring)

1) "F1" Error

- ① Occurring Condition: F-Sensor Disconnection / Short Circuit
- ② Control Method: F-Fan & Comp run as following in accordance with RT-S.
(But if RT-S error occurs at the same time, On/Off 25min./25min. Operation will occur.)
- ③ Cancellation: Automatically cancelled if F-Sensor is normal.

RT-S Standard	~ 8℃	~14℃	~20℃	~30℃	~42℃	42℃~
On/Off (min)	14/50	16/41	27/45	26/22	35/20	35/20

2) "r1" Error

- ① Occurring Condition: R-Sensor Disconnection / Short Circuit
- ② Control Method: F-Fan & Comp run as following in accordance with RT-S.
(But only when Comp is On by F-S, On/Off occurs by the time per the following RT condition.
If RT-S error occurs at the same time, On/Off 3min/7min operation occurs only at Comp

On state)

- ③ Cancellation: Automatically cancelled if R-Sensor is normal.

RT-S Standard	~ 8℃	~14℃	~20℃	~30℃	~42℃	42℃~
On/Off (min)	Off	3/50	2/10	3/7	4/6	6/4

3) "rt" Error

- ① Occurring Condition: RT-Sensor Disconnection / Short Circuit
- ② Control Method: Normal operation will occur, while ignoring controls by the RT-Sensor.
- ③ Cancellation: Automatically cancelled if RT-Sensor is normal.
- ④ Front PCB detects RT-Sensor. As communication is made with Main PCB, RT-Sensor is detected every 10 min.

4) "d1" Error

- ① Occurring Condition: D-Sensor Disconnection / Short Circuit
- ② Control Method: D-HTR On for 30 min.
- ③ Cancellation: Automatically cancelled if D-Sensor is normal.

5) "dF", "dr", "dH" Error (Detection of F/R/home-bar Door Switch Error, respectively)

- ① Occurring Condition: Door Open is detected for longer than one hr.
- ② Control Method: Functions related to a Door Switch detection is ignored.
- ③ Cancellation: Automatically cancelled if Door Switch Open/Close is detected.

6) "C1" Error

- ① Occurring Condition: With 3 hr of Comp operation, D-Sensor is -5℃ or higher.
- ② Control Method: Normal operation will occur.
- ③ Cancellation: When, at Comp Off, D-Sensor < -5℃

7) "F3" Error

- ① Occurring Condition: Returning by the Defrosting time limit of 60 min.
- ② Control Method: Normal operation will occur.
- ③ Cancellation: Automatically cancelled, if Defrosting is returned by the D-Sensor.

Contents

8) "Co" Mode : Short Circuit Operation

- ① Occurring Condition: Pressing "Fridge Adjustment" + "Freezing Adjustment" 10 times at the "Locked" state
- ② Control Method: Comp & F/C-Fan continuous operation
- ③ Cancellation: Automatically cancelled after a continual operation for 30 hr (Power re-supplied).

9) "d2" Mode (A/S Forced Defrosting Mode)

- ① Occurring Condition: Pressing "Fridge Adjustment" + "Freezing Adjustment" 5 times at the "Locked" state
- ② Control Method: A/S Forced Defrosting Control
- ③ Cancellation: Automatically cancelled, if D-Sensor is 13°C or higher.

10) "d3" Mode : Consuming Power Forced Defrosting Mode

- ① Occurring Condition: Pressing "Freezing Adjustment" + "Ice Choice" + "Lock Choice" 5 times.
- ② Control Method: At normal Defrosting mode, it starts process from Precool.
- ③ Cancellation: When Power is re-supplied.

11) "E1" Error

- ① Starting Condition: I-Sensor Disconnection & Short Circuit (But Ice Separation is paused if full ice is detected.)
- ② Control Method: Ice Separation occurs every 4.8 hr after a Water-supply.
- ③ Cancellation: Automatically cancelled, if I-Sensor is normal.

12) "Eg" Error

- ① Starting Condition: When I-Sensor Temperature Check is checked (5 min. after Water-supply), or if the Temperature does not go up to a certain point.
- ② Control Method: Normal Control occurs. (If there is an error 3 times, it will be paused.)
- ③ Cancellation: Automatically cancelled, if it is normal.

13) Ice Separation Motor Disorder (There is no pertinent Display)

- ① Starting Condition: When the Ice Separation motor is in disorder (it does not work). Press Ice Separation Test S/W to check.
- ② Control Method: The Ice Separation motor is replaced.

14) "H5" Error

- ① Starting Condition: Humidity-Sensor Disconnection & Short Circuit
- ② Control Method: At a home-bar Heater On/Off or Defrosting start condition, the starting condition by the Humidity Sensor is ignored.
- ③ Cancellation: Automatically cancelled, if Humidity-Sensor is normal.

* All Error Codes will be reset if it returns to a normal state.

6-18. Function Buttons Summary

Contents		
1. Mode Starting Method for each Function (Except for Filter Reset, all Option functions starts at "Locked" state.)		
NO	Mode	Mode Operation Method
1	JIG Mode Starting	Freezing Adjustment + Ice Choice 5 times
2	A/S Forced Defrosting	Freezing Adjustment + Fridge Adjustment 5 times
3	Demo Function	Fridge Adjustment + Ice Choice 5 times
4	Short Circuit Function	Fridge Adjustment + Freezing Adjustment 10 times
5	Freezer Fine Tuning	Freezing Adjustment pressed for 10 sec.
6	Fridge Fine Tuning	Fridge Adjustment pressed for 10 sec.
7	EEPROM Clear	Ice Choice + Fridge Choice 10 times
8	Filter Reset Function	Lock Cancel, Ice Choice pressed 3 times
9	Ice Machine Test Function	Ice Machine Test SW pressed for one sec.

6-19. How to Read Sensor Temperature



Start: Press “Freezer” Button at “Locked” state and touch “Lock Setup” Button 5 times.

(The same as Error Display Mode start)

Cancellation: Touch “Lock Function” Button once

Or automatically cancelled 4 min. after starting.

► As Error Display Mode starts, the refrigerator operation time is displayed. Following are displayed in that order for every “Freezer” Key pressing.

1. Refrigerator Operation Time Display
2. F-Sensor Temperature Display
3. D-Sensor Temperature Display
4. R-Sensor Temperature Display
5. RT(Surrounding Temperature)-Sensor Temperature Display
6. Water-supplying Time at the Water-supply mode
7. Humidity Sensor Temperature Display

※ Note: Only when there is an Error, following #8 ~ 19 Error Codes are displayed, in that order.

※ If an Error does not take place, it is Skipped.

8. F1 (F-Sensor Disconnection/Short Circuit)

9. r1 (R-Sensor Disconnection/Short Circuit)

10. rt (RT-Sensor Disconnection/Short Circuit)

11. d1 (D-Sensor Disconnection/Short Circuit)

12. dr (R-Door Switch Bad)

13. dF (F-Door Switch Bad)

14. dH (Home bar Door Switch Bad)

15. C1 (Condenser Cycle Abnormal)

16. EP (EEPROM Abnormal)

17. d2 (≡ ≡ d2 Display, A/S Forced Defrosting Mode Display)

18. Co (Short Circuit Mode Display)

19. H5 (Humidity Sensor Disconnection/Short Circuit)

R/F/D-Sensor Temperature Display Value

(R Standard:31.4K, F Standard:25.5K)

R / D -Sensor				F-Sensor			
Temperature	Standard(kΩ)	Temperature	Standard(kΩ)	Temperature	Standard(kΩ)	Temperature	Standard(kΩ)
-30.0	129.30	0.5	29.34	-30.0	39.652	0.5	7.692
-29.5	125.90	1.0	28.71	-29.5	38.495	1.0	7.508
-29.0	122.50	1.5	28.08	-29.0	37.375	1.5	7.328
-28.5	119.30	2.0	27.47	-28.5	36.291	2.0	7.153
-28.0	116.20	2.5	26.88	-28.0	35.242	2.5	6.983
-27.5	113.20	3.0	26.30	-27.5	34.227	3.0	6.818
-27.0	110.20	3.5	25.74	-27.0	33.240	3.5	6.656
-26.5	107.40	4.0	25.19	-26.5	31.372	4.0	6.500
-26.0	101.60	4.5	24.65	-26.0	30.926	4.5	6.347
-25.5	101.90	5.0	24.13	-25.5	30.480	5.0	6.198
-25.0	99.30	5.5	23.62	-25.0	29.616	5.5	6.054
-24.5	96.70	6.0	23.12	-24.5	28.780	6.0	5.913
-24.0	94.30	6.5	22.63	-24.0	27.970	6.5	5.776
-23.5	91.90	7.0	22.15	-23.5	27.185	7.0	5.642
-23.0	89.60	7.5	21.69	-23.0	26.425	7.5	5.512
-22.5	87.30	8.0	21.24	-22.5	25.686	8.0	5.386
-22.0	85.10	8.5	20.80	-22.0	24.974	8.5	5.262
-21.5	83.00	9.0	20.36	-21.5	24.283	9.0	5.142
-21.0	80.90	9.5	19.94	-21.0	23.612	9.5	5.025
-20.5	78.90	10.0	19.53	-20.5	22.963	10.0	4.911
-20.0	76.90	10.5	19.13	-20.0	22.333	10.5	4.800
-19.5	75.00	11.0	18.74	-19.5	21.722	11.0	4.691
-19.0	78.20	11.5	18.35	-19.0	21.130	11.5	4.586
-18.5	71.40	12.0	17.98	-18.5	20.557	12.0	4.483
-18.0	69.60	12.5	17.61	-18.0	20.000	12.5	4.383
-17.5	67.90	13.0	17.26	-17.5	19.460	13.0	4.285
-17.0	66.30	13.5	16.91	-17.0	18.937	13.5	4.190
-16.5	64.70	14.0	16.37	-16.5	18.429	14.0	4.097
-16.0	63.10	14.5	16.26	-16.0	17.937	14.5	4.007
-15.5	61.60	15.0	15.91	-15.5	17.459	15.0	3.918
-15.0	60.10	15.5	15.59	-15.0	16.995	15.5	3.832
-14.5	58.60	16.0	15.28	-14.5	16.545	16.0	3.749
-14.0	57.20	16.5	14.98	-14.0	16.109	16.5	3.668
-13.5	55.90	17.0	14.66	-13.5	15.635	17.0	3.587
-13.0	54.60	17.5	14.39	-13.0	15.274	17.5	3.509
-12.5	53.30	18.0	14.10	-12.5	14.875	18.0	3.433
-12.0	52.00	18.5	13.83	-12.0	14.487	18.5	3.350
-11.5	50.80	19.0	13.56	-11.5	14.111	19.0	3.287
-11.0	49.60	19.5	13.29	-11.0	13.746	19.5	3.217
-10.5	48.70	20.0	13.03	-10.5	13.391	20.0	3.148
-10.0	47.30	20.5	12.78	-10.0	13.047	20.5	3.081
-9.5	46.20	21.0	12.53	-9.5	14.712	21.0	3.015

R / D-Sensor				F-Sensor			
Temperature	Standard(k Ω)	Temperature	Standard(k Ω)	Temperature	Standard(k Ω)	Temperature	Standard(k Ω)
-9.0	45.10	21.5	12.29	-9.0	12.387	21.5	2.927
-8.5	44.10	22.0	12.05	-8.5	12.072	22.0	2.839
-8.0	43.10	22.5	11.82	-8.0	11.765	22.5	2.829
-7.5	42.10	23.0	11.60	-7.5	11.467	23.0	2.769
-7.0	41.10	23.5	11.37	-7.0	11.176	23.5	2.711
-6.5	40.30	24.0	11.16	-6.5	10.897	24.0	2.655
-6.0	39.30	24.5	10.95	-6.0	10.624	24.5	2.600
-5.5	37.90	25.0	10.74	-5.5	10.358	25.0	2.546
-5.0	37.50	25.5	10.54	-5.0	10.109	25.5	2.493
-4.5	36.70	26.0	10.34	-4.5	9.849	26.0	2.442
-4.0	35.80	26.5	10.14	-4.0	9.605	26.5	2.392
-3.5	35.00	27.0	9.945	-3.5	9.368	27.0	2.343
-3.0	34.30	27.5	9.768	-3.0	9.138	27.5	2.295
-2.5	33.50	28.0	9.586	-2.5	8.913	28.0	2.246
-2.0	32.70	28.5	9.408	-2.0	8.696	28.5	2.202
-1.5	32.00	29.0	9.234	-1.5	8.484	29.0	2.158
-1.0	31.30	29.5	9.063	-1.0	8.277	29.5	2.114
-0.5	30.60	30.0	8.896	-0.5	8.077	30.0	2.072
0.0	30.00			0.0	7.882		

7. Disorder Diagnosis & Repair

- Contents -

7-1. When Power is not Supplied

(Freezing / Fridges Light Disconnection & F-PCB Power Dead)

7-2. Freezing / Fridge Weak

7-2-1. No / Weak Freezing (Food melting / Slow freezing)

7-2-2. No / Weak Refrigeration (Food not cooled / Slow cooling)

7-3. Freezer Louver Freezing

7-4. Freezing / Fridges Light Disconnection (LED LAMP)

7-5. Defrosting Poor

7-6. Dewing Inside Fridge

7-7. Noise

7-7-1. Discerning of Noise Source

7-7-2. Comp Noise

7-7-3. Refrigerant Flowing Noise

7-7-4. Fan Noise

7-7-5. Pipe Vibration / Interference Noise

7-8. Door Part (When Door is closed, alert beeping sounds continually every minute for 5 minutes)

7-9. Adjustment of Difference between the top-points of the Freezer & the Fridge Compartment Doors

7-10. Refrigerator Cycle Repair

7-10-1. Diagnosis Method (No Freezing /Refrigeration)

7-10-2. Actions & Precautions per Symptom

7-10-3. CYCLE(R-600a) Repair Tool Set Guide

7-10-4. CYCLE(R-600a) Repair Preparation Materials

7-10-5. Order of CYCLE(R-600a) Repair Work (COMP Replacement)

7-10-6. Notes on CYCLE(R-600a) Repair

7-1. When Power is not Supplied
(Freezing / Fridges Light Disconnection & F-PCB Power Dead)

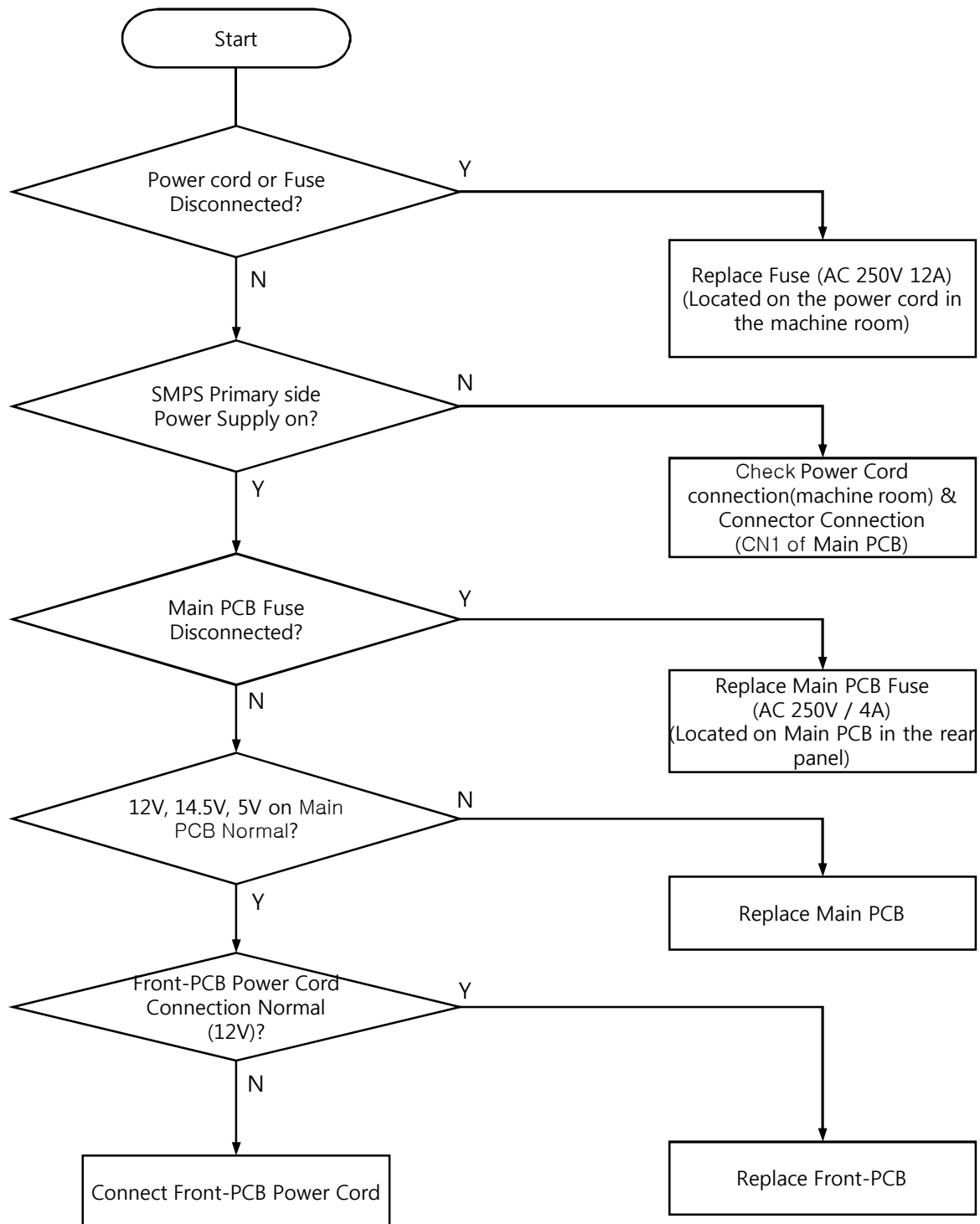

7-2. Freezing / Fridge Weak

7-2-1. No / Weak Freezing (Food melting / Slow freezing)
- Normal compressor

※ Error Mode Check Method
Press "Water" Button 5 times with
"Freezing Adjustment" Button pressed

※ Error Code
F1 : F-Sensor Disconnection/Short Circuit (F-Sensor Check)
C1 : Abnormal Cycle (Comp, Refrigerant Leak)
r1 : R-Sensor Disconnection/Short Circuit (F-Sensor Check)
F3 : Abnormal Return from Defrosting (Check Temperature Fuse & Defrosting Heater)

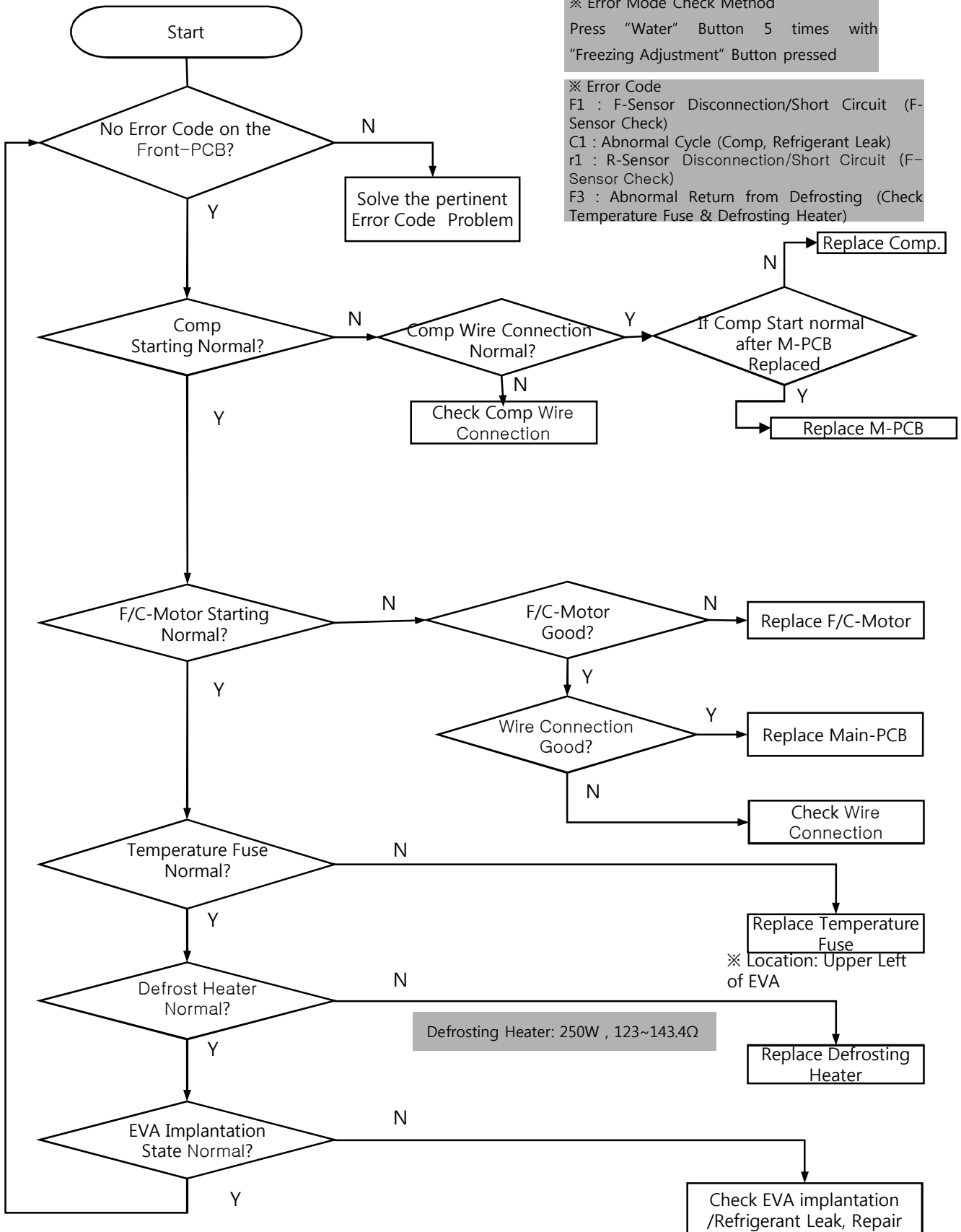

- Inverter compressor

※ Error Mode Check Method

Press "Lock" Button 5 times with "Freezing Adjustment" Button pressed".

※ Error Code

F1 : F-Sensor Disconnection/Short Circuit(Check F-Sensor)
 F3 : Abnormal Return from Defrosting(Check Temperature Fuse,, F Defrosting Heater)
 r1 : R-Sensor Disconnection/Short Circuit(Check R-Sensor)
 C1 : Abnormal Cycle (Comp, Refrigerant Leak)

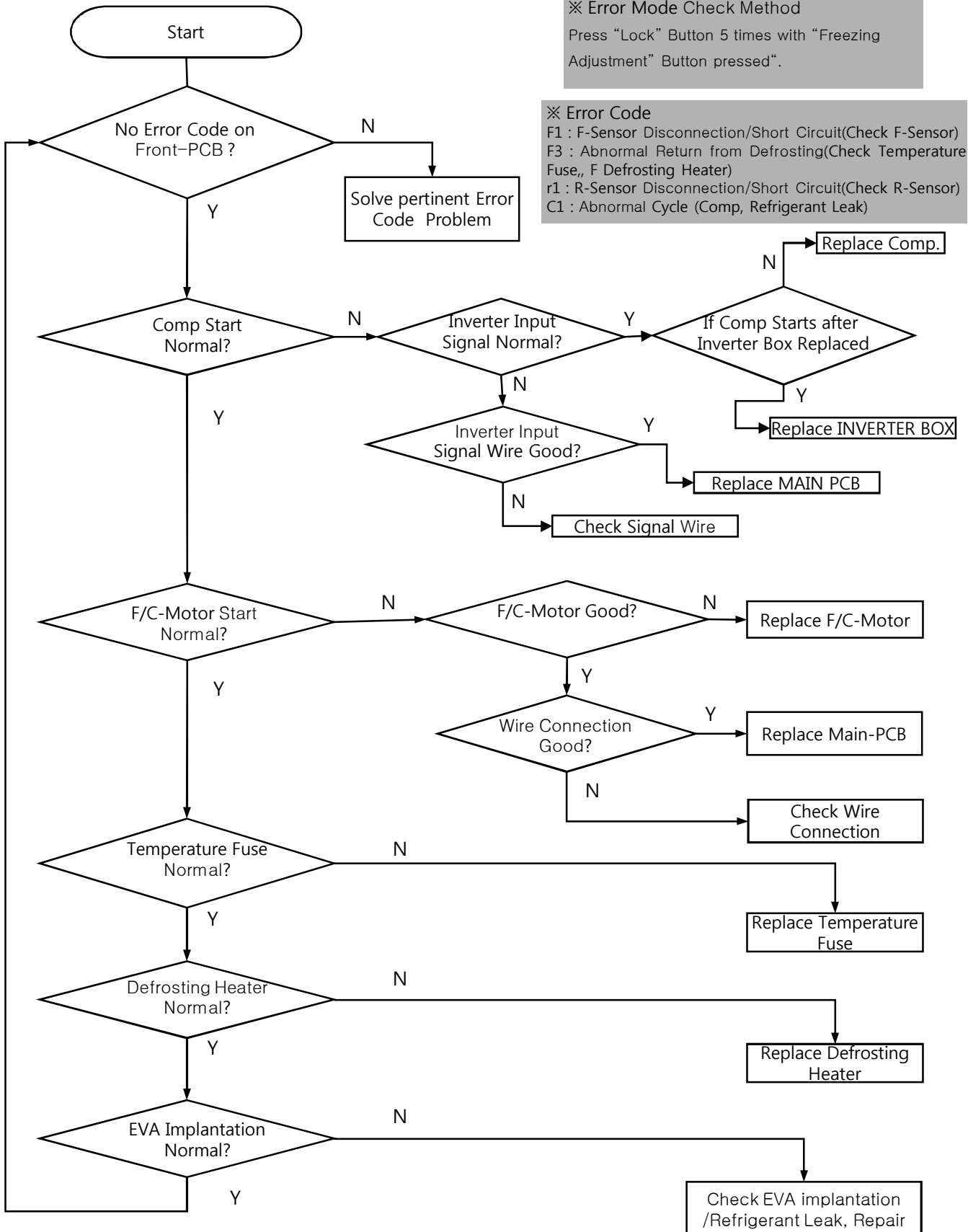

7-2-2. No / Weak Refrigeration (Food not cooled / Slow cooling)

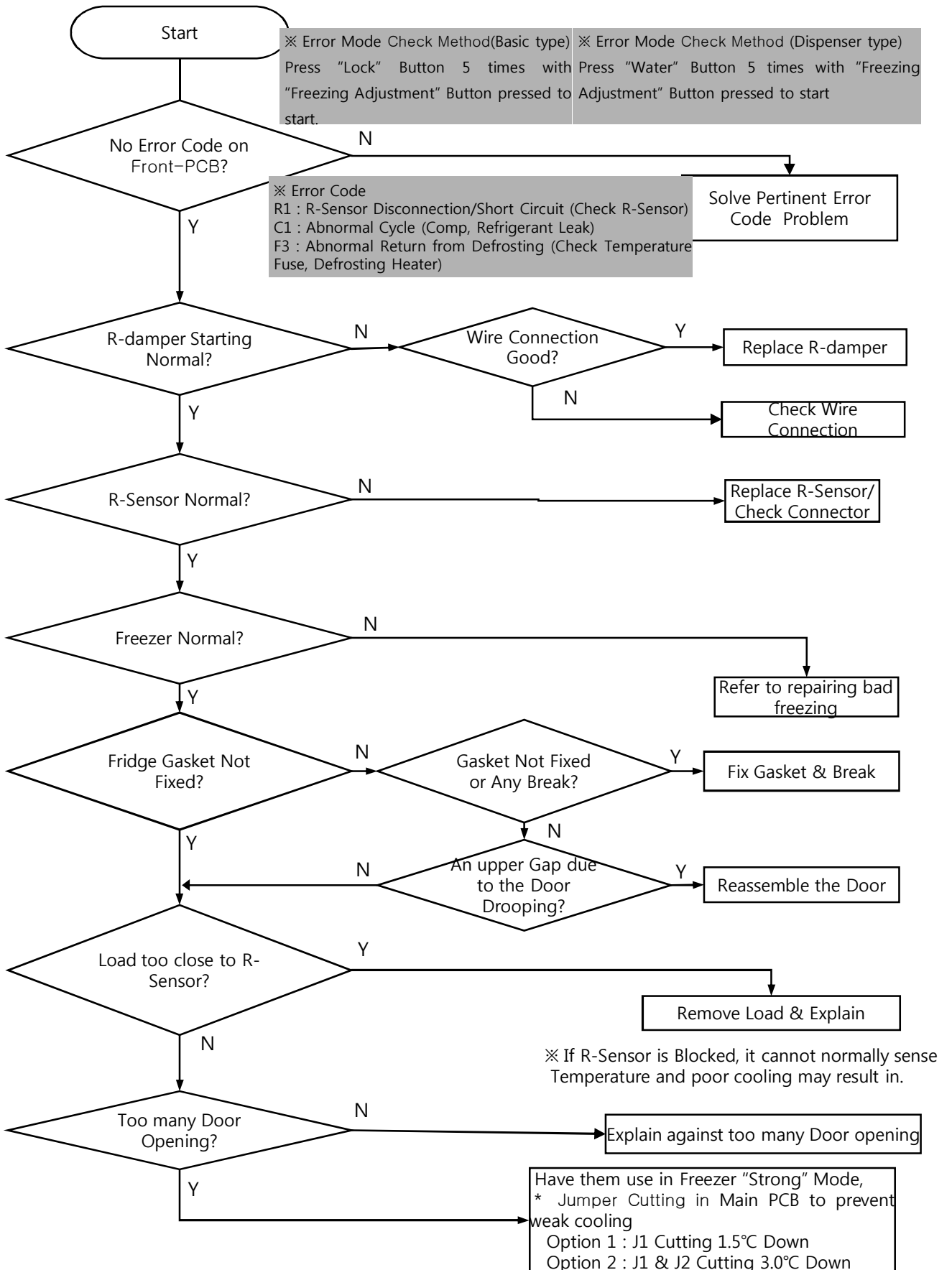

7-3. Freezer Louver Freezing

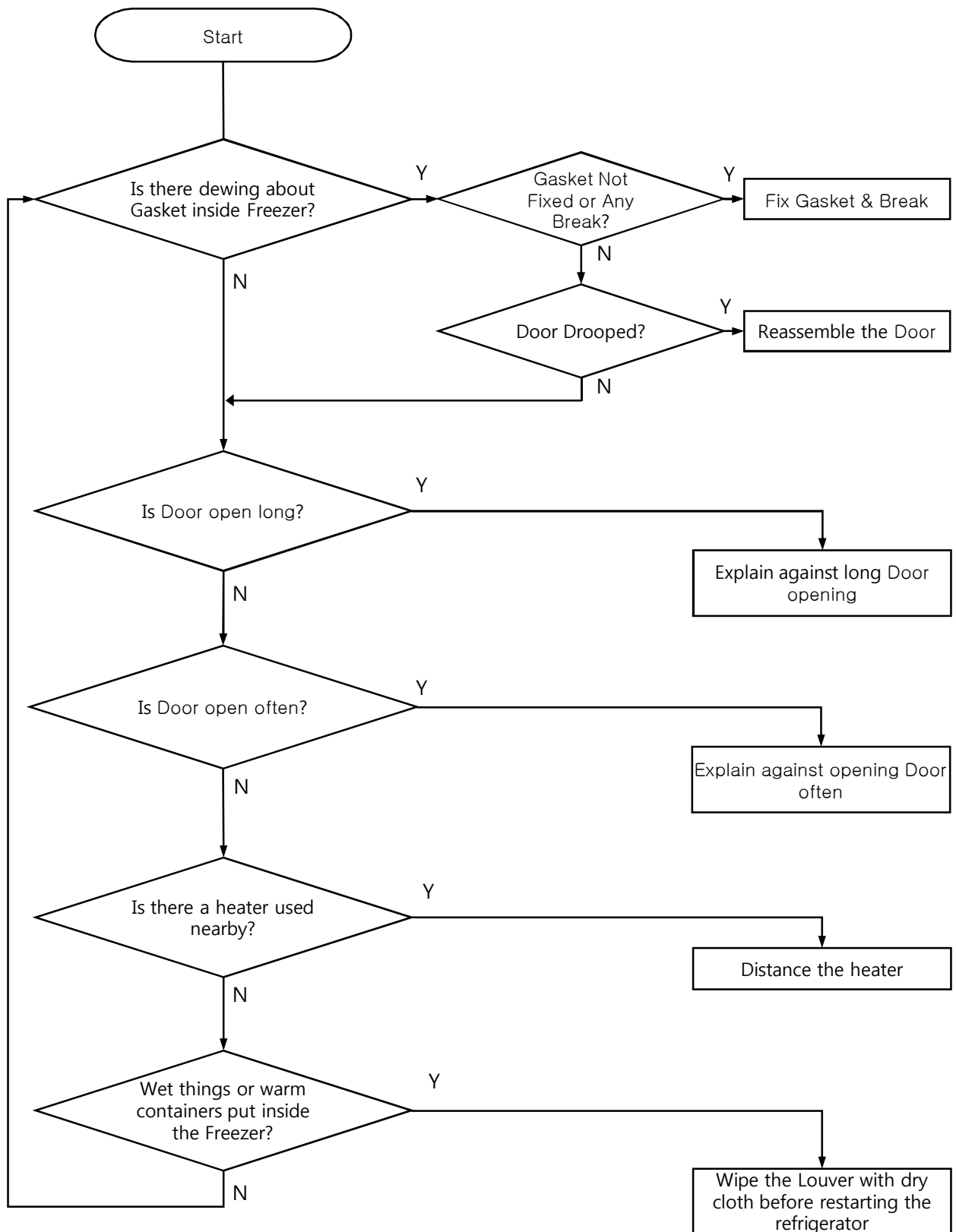

7-4. Freezing / Fridges Light Disconnection (LED LAMP)

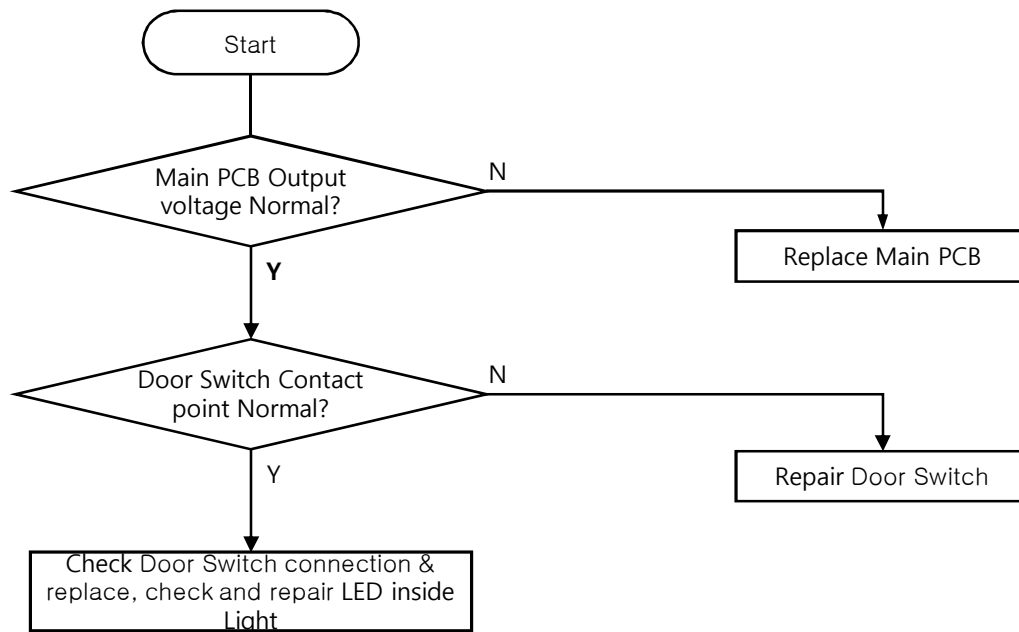

Note

- | |
|---|
| <ul style="list-style-type: none">● Refer to the Disassembling method of the Inside Lights and the Door Switch. |
|---|

7-5. Defrosting Poor

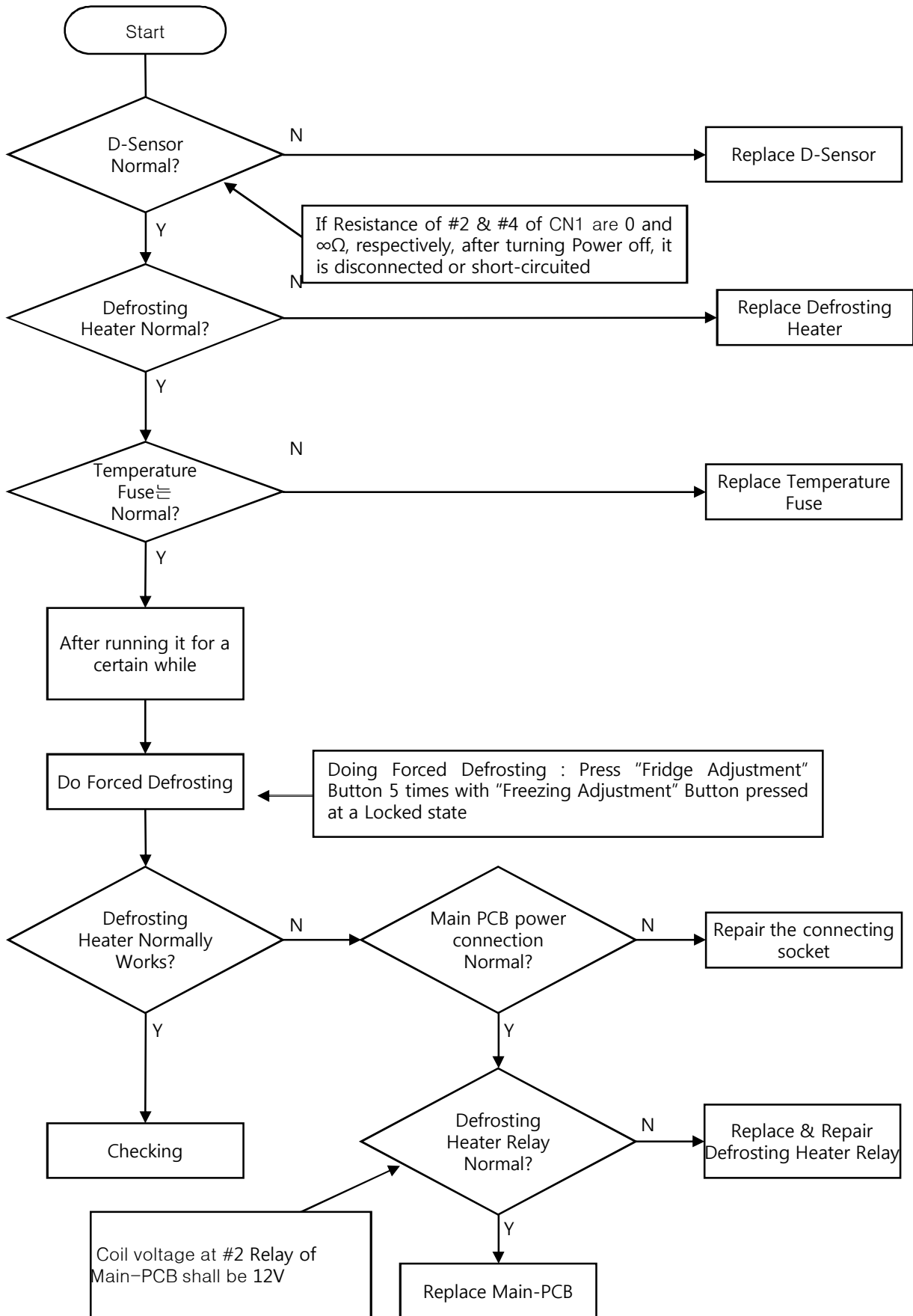

7-6. Dewing Inside Fridge

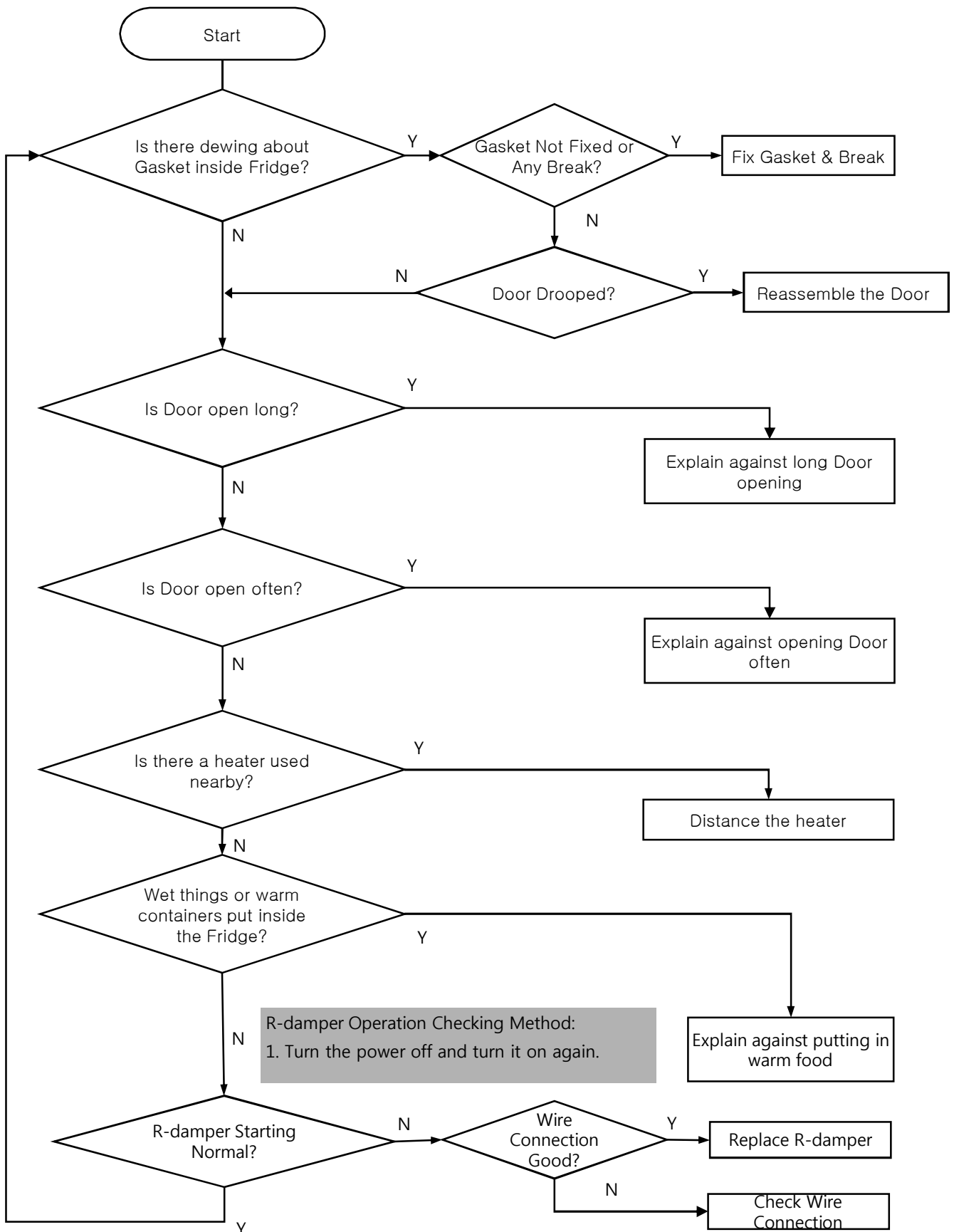

7-7. Noise

7-7-1. Discerning of Noise Source

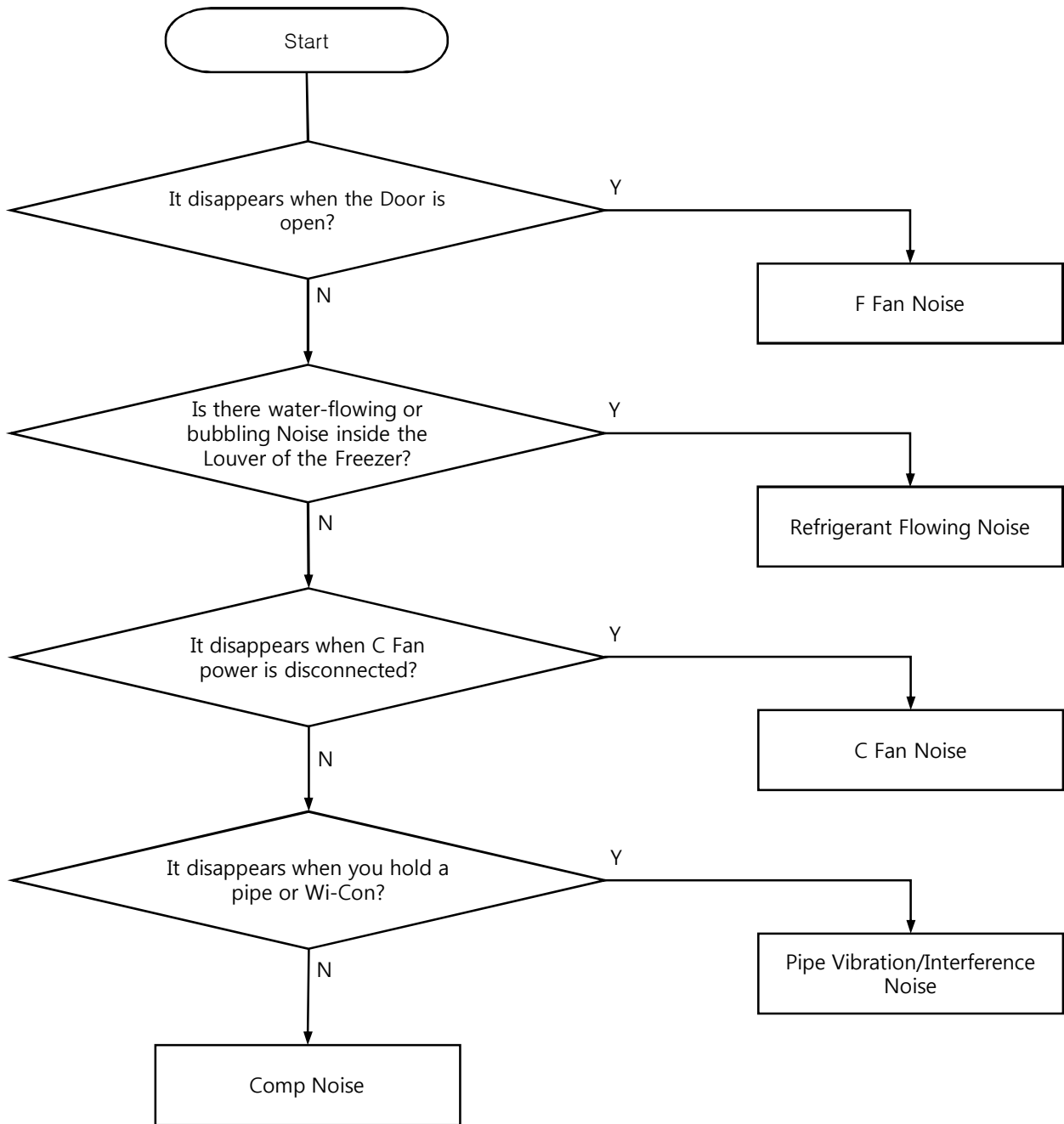

Notes

- Above is the way to discern Noise while the Refrigerator is running. (For Noise when it is stopped, refer to the 'Refrigerant Flowing Noise'.)
- For an exact discerning, check of the response of the customer is necessary.

7-7-2. Comp Noise

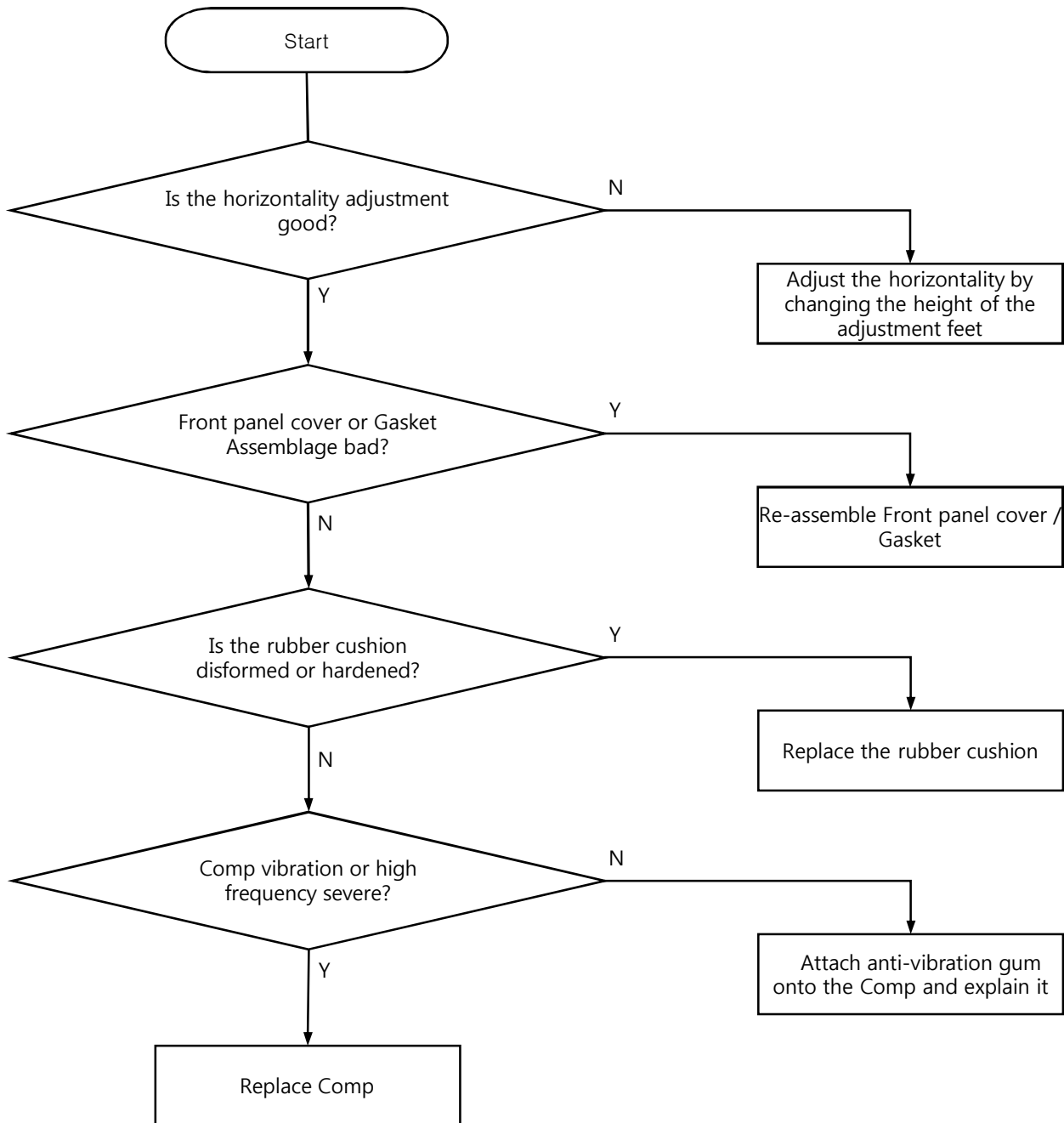

Notes

- Comp Noise is inevitable during operation, because the Comp rotates fast to make the Refrigerant flow.
- Clattering Noise may occur due to the vibration of the motor or the piston when the Comp starts or ends operation.

7-7-3. Refrigerant Flowing Noise

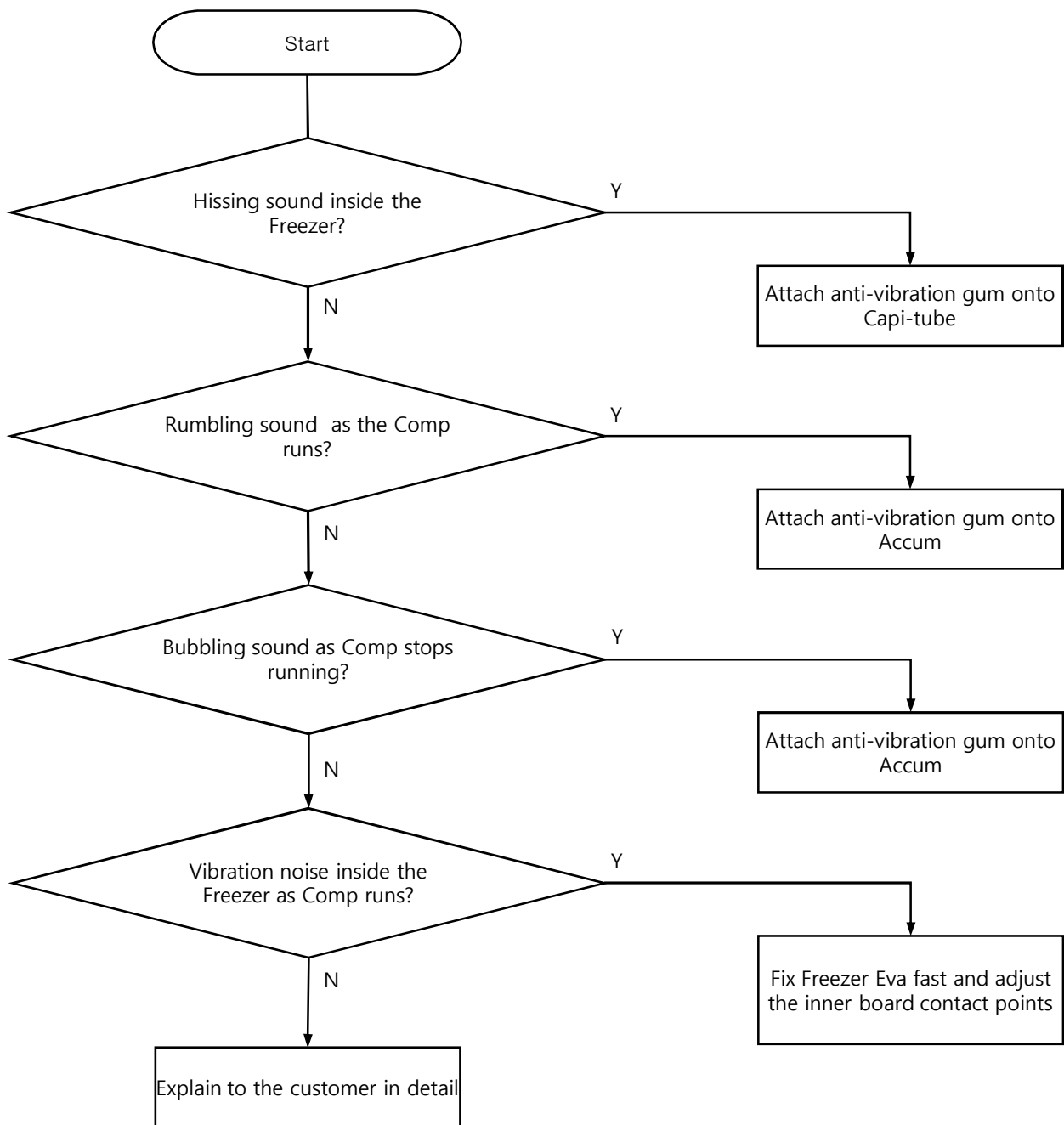

Notes

- The refrigerant flowing noise in Comp running or bubbling noise at Comp stoppage is normal as they are due to the process of the inner refrigerant transforming to liquid or gas.

Actions to take for the Noise from Eva

1. Hissing Noise at Capi-tube

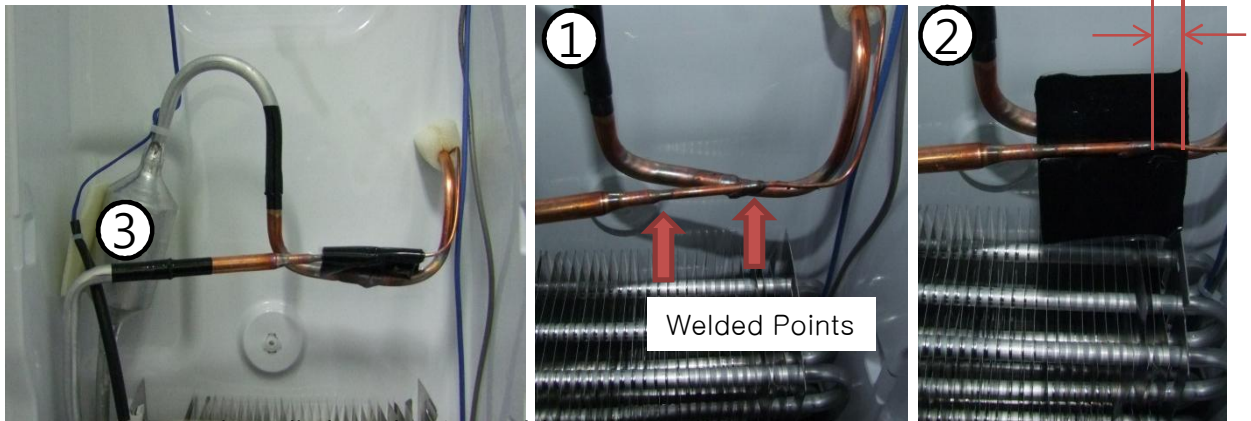

1) Connecting tube called 'I-tube' is used between Capi-tube and Eva, and anti-vibration gum is attached onto the I-tube. Check if there is any bending, etc. on the tube, after removing the anti-vibration gum.

2) The arrows in Picture ① give the welded points of the 'I-tube'. The anti-vibration gum shall be attached as in Picture ② so that all the welded points may be wrapped in. (The point on the Capi-tube shall be wrapped, with the margin of at least 10mm beyond the point covered.)

2. Rumbling or bubbling noise from Accum

1) Anti-vibration gum should be attached onto the ③ area of the picture above. (Existing Seal should be removed.)

2) Separate the Accum from the inner board after the anti-vibration gum is attached.

3) Take care not to have the tubing bended, when separating them, and the Seal shall be attached onto the previous location to maintain the distance with the inner board.

3. Eva Vibration Noise

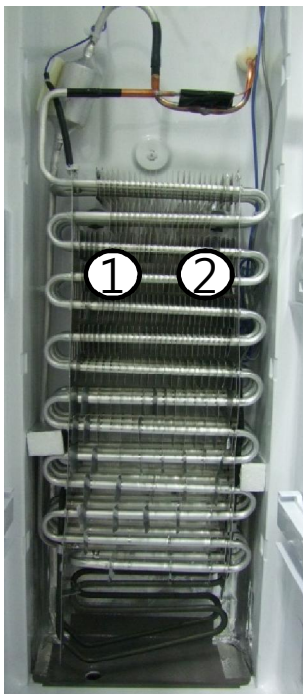

1) The Fixture ①, ② are to fix the Eva onto the inner board. Assemble it so that they are closely attached.

2) Insert EPS (Styrofoam) between left and right sides of Eva and the inner board so that it may not be movable.

7-7-4. Fan Noise

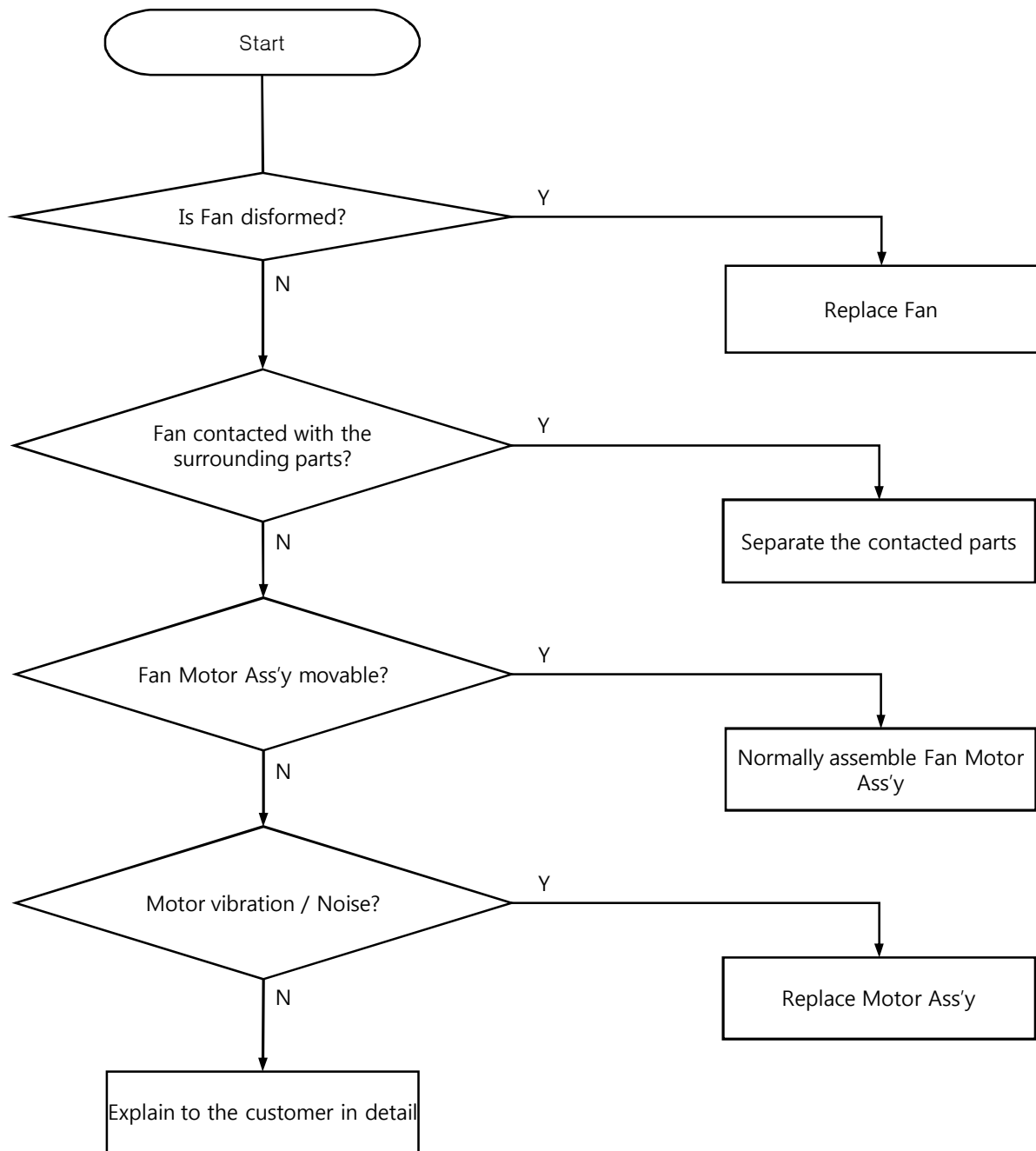

Notes

- The fan runs to circulate the cool air inside the refrigerator, so the noise from the wind hitting Louver or the inner board is normal.

7-7-5. Pipe Vibration / Interference Noise

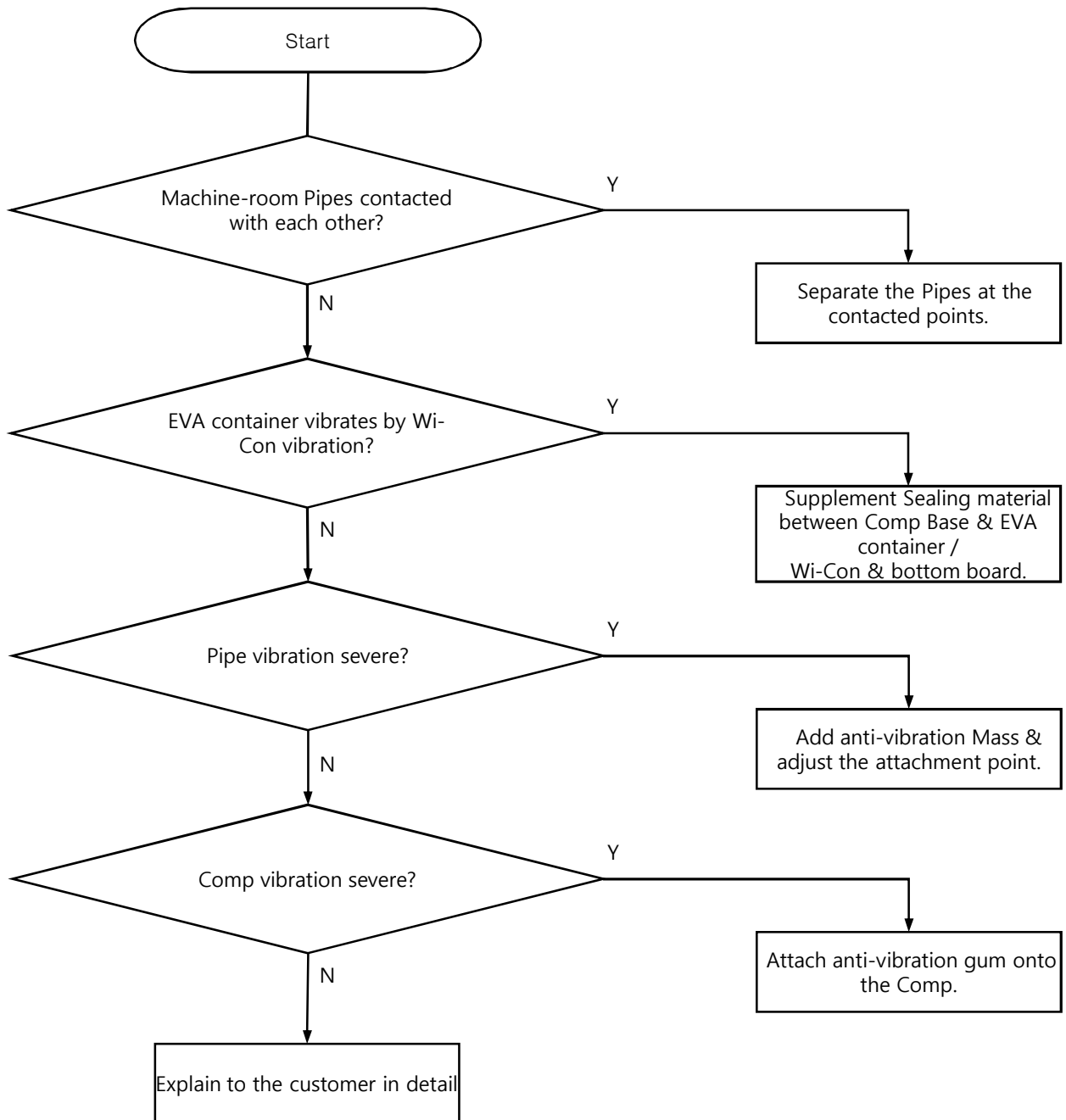

Notes

- There may be pipe vibration because Comp circulates the refrigerant with high pressure.
- When Comp vibration is transmitted to Pipe, tightly attach anti-vibration mass on the welding point or the sharply bended point on the pipe between the pipe and Comp.

7-8. Door Part (When Door is closed, alert beeping sounds continually every minute for 5 minutes)

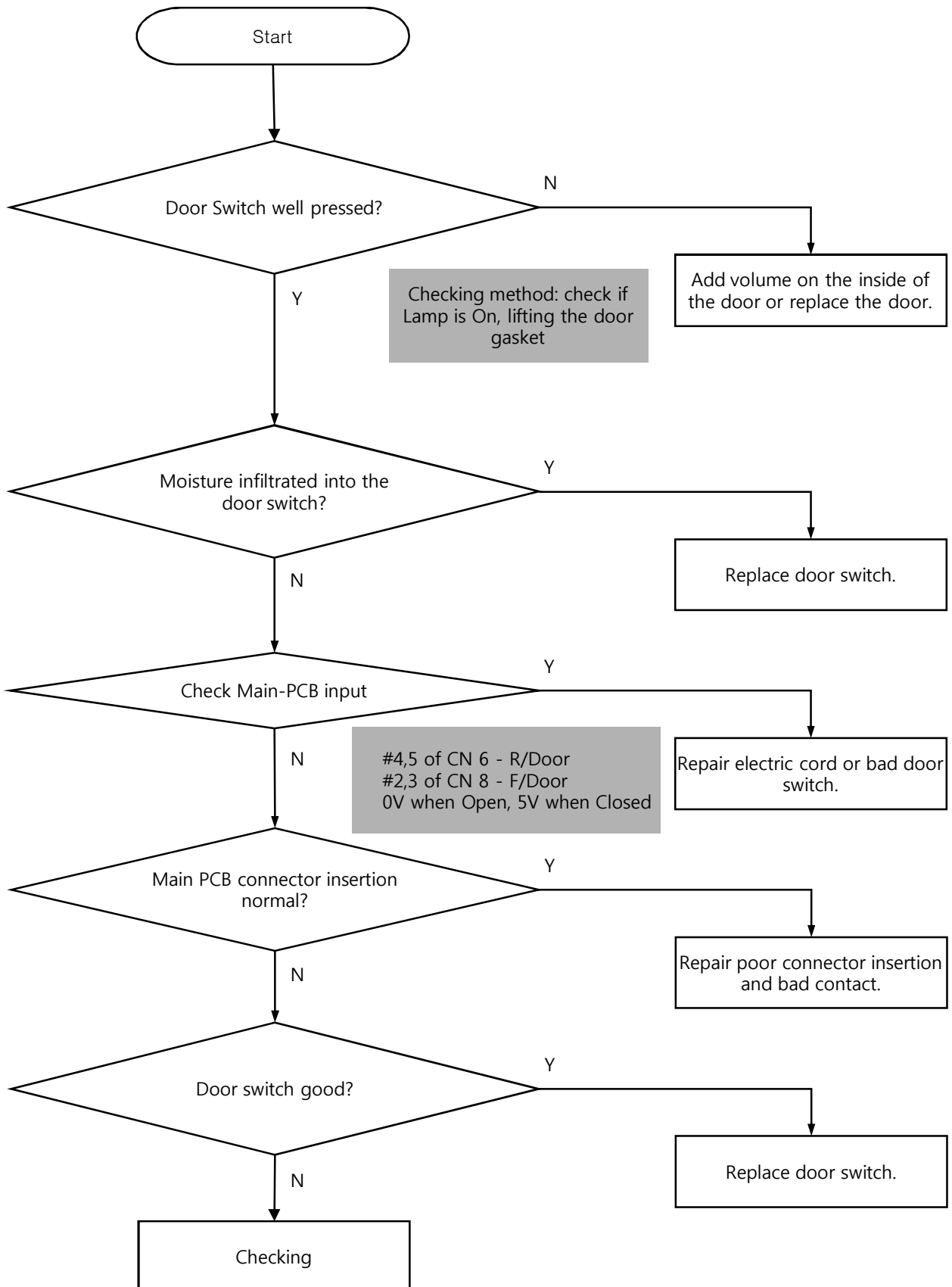

7-9. Adjustment of Difference between the top-points of the Freezer & the Fridge Compartment Doors

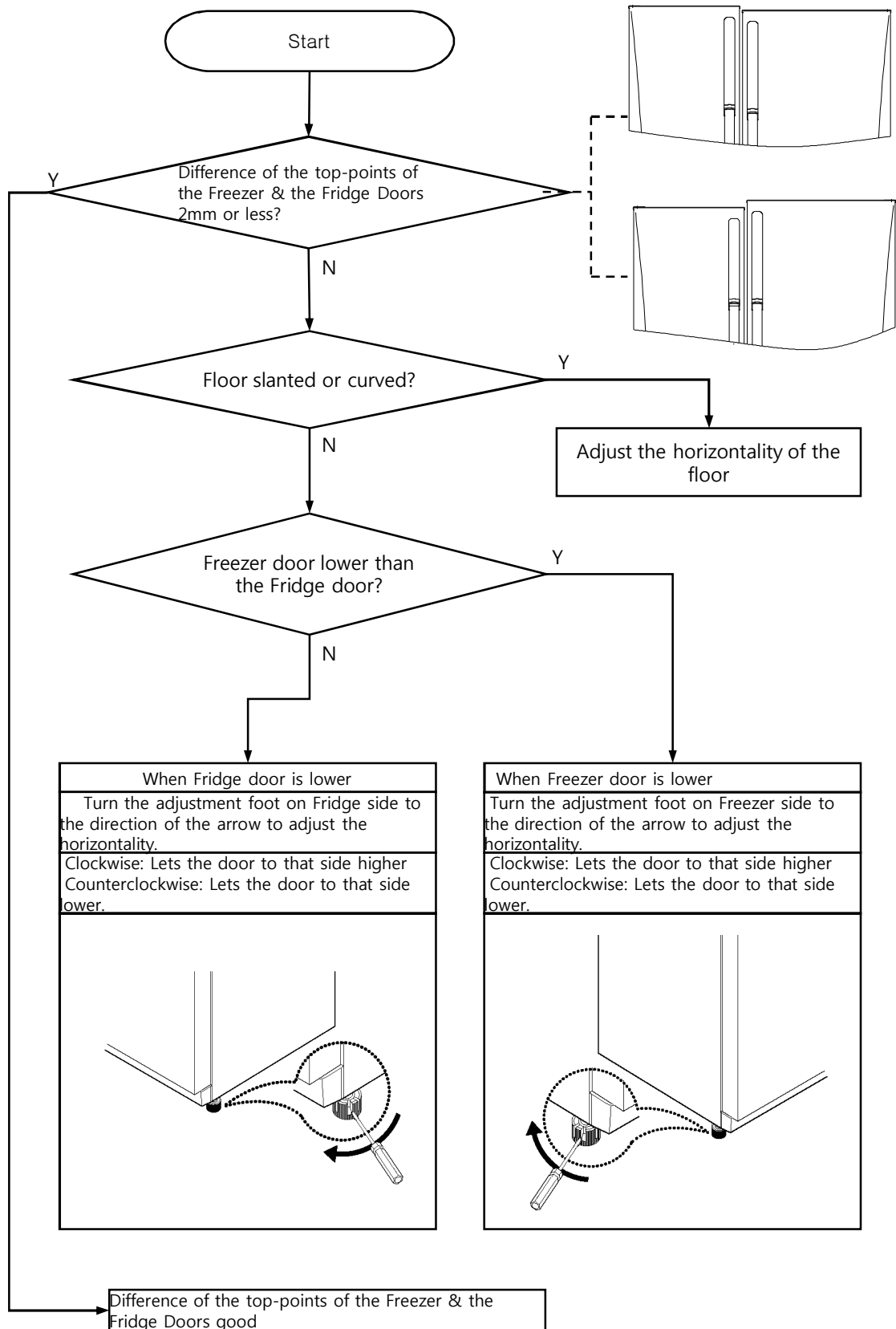

7-10. Refrigerator Cycle Repair

7-10-1. Diagnosis Method (No Freezing/Refrigeration)

1) Check the heat discharge at the COMP outlet while COMP is on. It depends on circumstances, but the temperature should be higher than the surrounding. If you have the COMP on after making it off for 10 min. or so, then you can easily detect the heat.

If there is no heat discharge detected, then it is not only due to bad GAS but one of the following:

- a) GAS leakage
- b) bad CYCLE blockage
- c) bad COMP (bad discharge).

2) For a more precise diagnosis, check the temperature at the inlet/outlet of the condenser.

- Condenser inlet temperature should be $-25^{\circ}\text{C} \downarrow$, while condenser outlet temperature should be $-20^{\circ}\text{C} \downarrow$ or so.
(It may depend on circumstances.)

If the temperature at the inlet drops while that at the outlet does not, it may be due to lack of the refrigerant by the GAS leakage.

One thing to remember is that you should have maintain both the Freezer and fridge Compartment in the "Strong" state long enough before checking the temperature drops.

3) If it is thought to be bad as a result of the above checking, follow the process in that order for repair.

- a) Have COMP stopped after having it run for 2~3min.
- b) Cut the capillary tube at the dryer outlet.
If the refrigerant GAS is not ejected now, it is due to a CYCLE blockage or a GAS leakage.
If the refrigerant GAS is ejected, it is due to a lack of GAS or bad COMP (bad discharge).

c) Bad blockage may be judged through nitrogen blowing.

(Blowing pressure should be 6 kgf/cm² or higher.)

Blowing direction should be toward the low pressure side of the COMP and you should check the discharge to the capillary tube and HOT-PIPE outlet.

d) To check the bad COMP (bad discharge) you should check the discharge pressure while the COMP is running.

It should be 20 kgf/cm² (it depending on circumstances) or more.

If you have no pressure gauge, the pressure should be one you cannot block by your hand.

e) To see if it is due to a GAS leakage: If the refrigerant gas is not ejected when you cut the capillary tube at the dryer outlet, check the possibility of a blockage. If it is not a blockage, then it is due to a leakage. To find the leakage point, use a leakage detector, basically before the destruction of the CYCLE (in the refrigerant-sealed state), or try to visually find out the oil leakage mark left on each pipe or welding point.

After a CYCLE destruction, use pressure gauge (0.001kgf/cm² or so) and soap water testing, after high pressure nitrogen gas is injected into the Cycle.

7-10-2. Actions & Precautions per Symptom

- 1) If although there is no problem with the temperature control part, the Freezer and the Fridge are not cooled, it is likely due to gas leakage or bad Comp compression.
→ When COMP runs continuously for 2 hr. or more or freezing/fridge state is bad, check if there is gas leak at various pipes. If there is no leak, replace the Comp, thinking it is due to a bad Comp compression.

But if at the initial start of COMP, the high-pressure pipe gets too hot within 3 min. to touch, it means Comp is good.
→ If this is the case (not bad compression), find the leakage point (weld point)of the gas and weld it, evacuate it and re-inject gas.

2) Bad COMPRESSOR start-up

- COMP starts up but stops within 3min. (refrigeration cycle blockage)
→ Trace the blocked points with weld material, thoroughly perform overhaul, evacuate it and re-inject gas.
- Check power supply part (electronic PCB connection part), re-insert it and solidly fix it.
- Check contact point states of the electronic units (PCB-side COMP relay, condenser).
- Check the resistance of the Comp terminal, if you want to see the COMP motor state.

3) How to check bad COMPRESSOR

3-1) COMPRESSOR Connection

- General Compressor(CMA121NAEM)

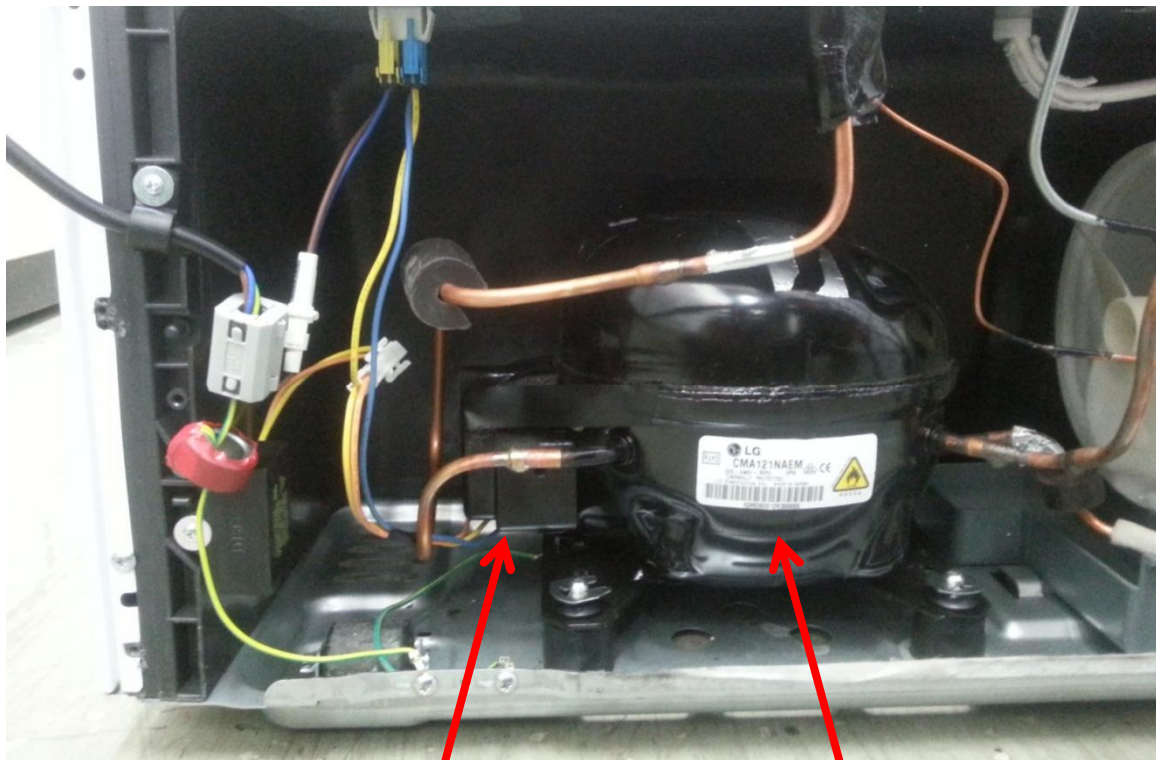

Compressor Relay Cover

COMPRESSOR

- INVERTER Compressor(VESD11C)

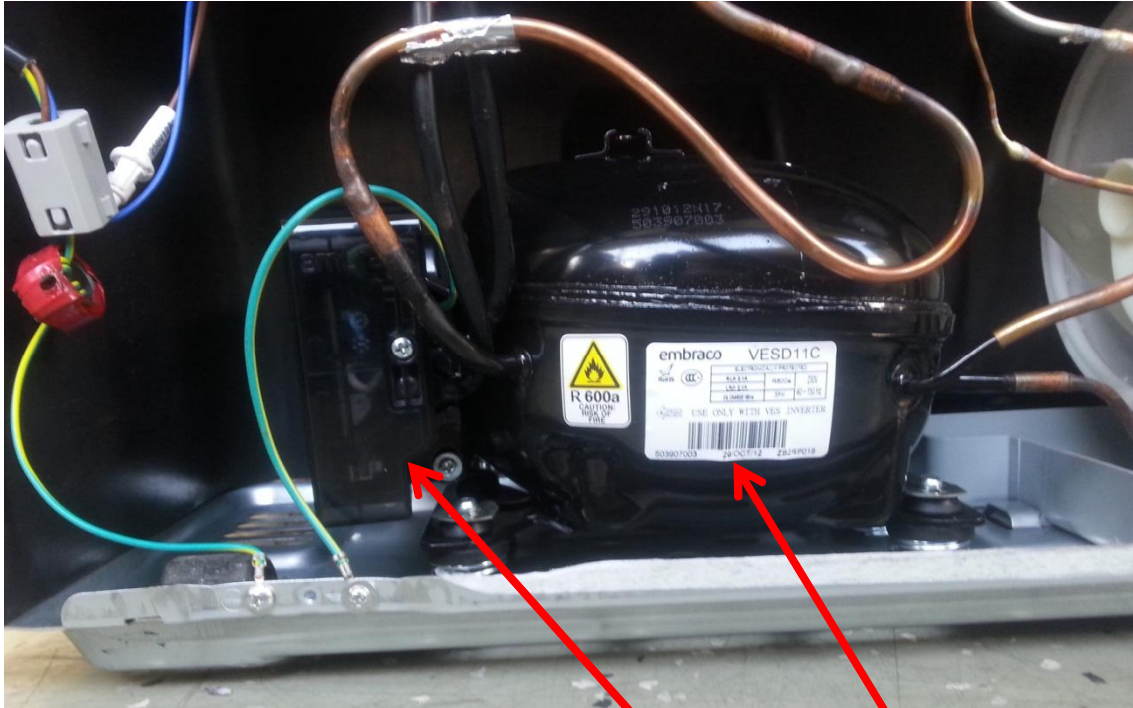

- INVERTER Compressor(ENV4A5G-L2B)

INVERTER BOX

COMPRESSOR



● General Compressor Wiring

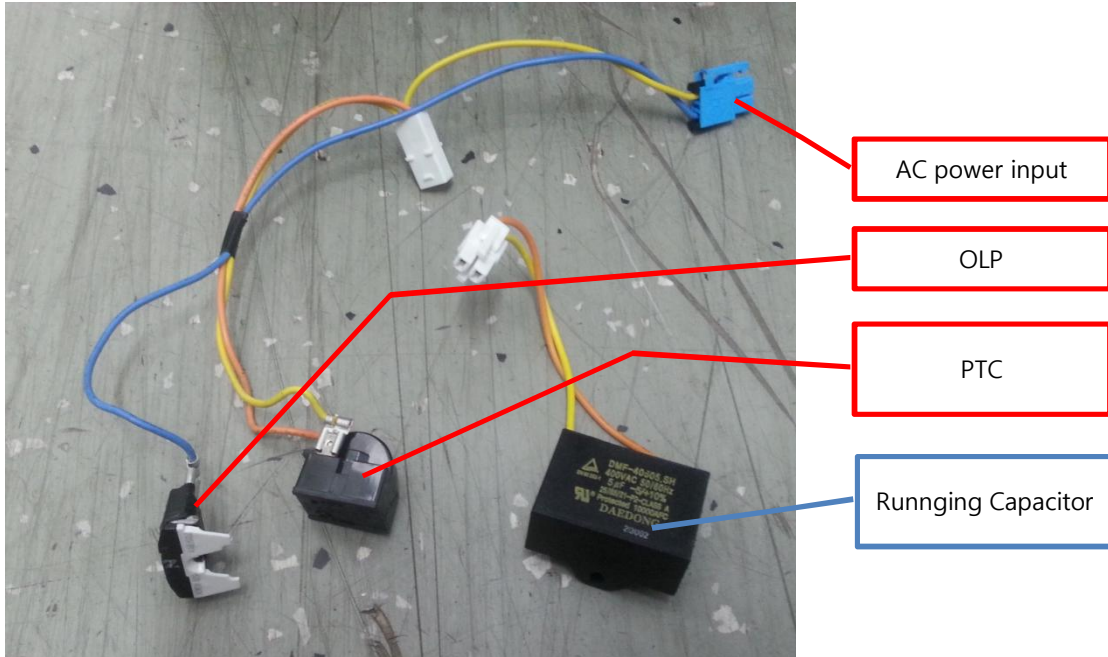

3-2) How to check the bad COMP terminal of a general COMPRESSOR

● COMP or Resistance value CHECKING

-> SUB resistance value = between COMMON & SUB terminal
 -> MAIN resistance value = between COMMON & MAIN terminal

=> Normal: SUB & MAIN resistance value checking is possible, and Comp works good when power is supplied.
 => Abnormal: If SUB & MAIN resistance checking is not possible, and power is not supplied, then it is bad

Average Resistance Value (at Room Temperature)	
SUB (Ω)	MAIN (Ω)
18.95 at 35°C	13.25 at 35°C

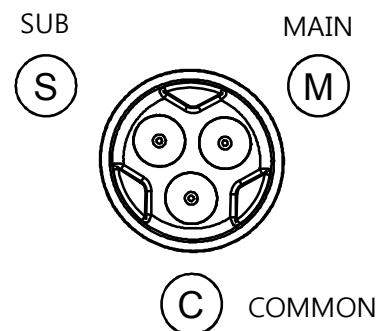
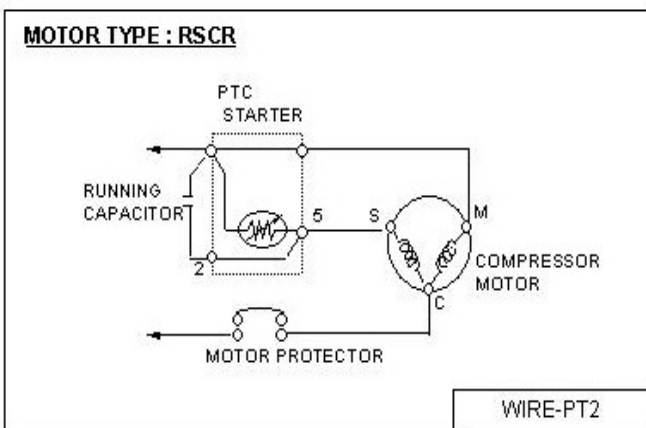

● Note
 The higher the temperature of the coil of the motor is, the larger the resistance will be.

● INVERTER BOX Wiring

- INVERTER BOX for VESD11C

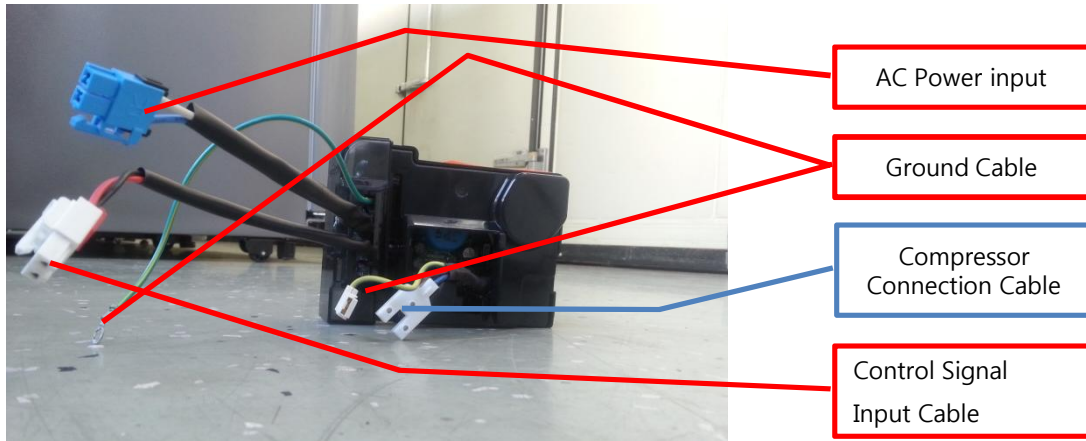

- INVERTER BOX for ENV4A5G-L2B

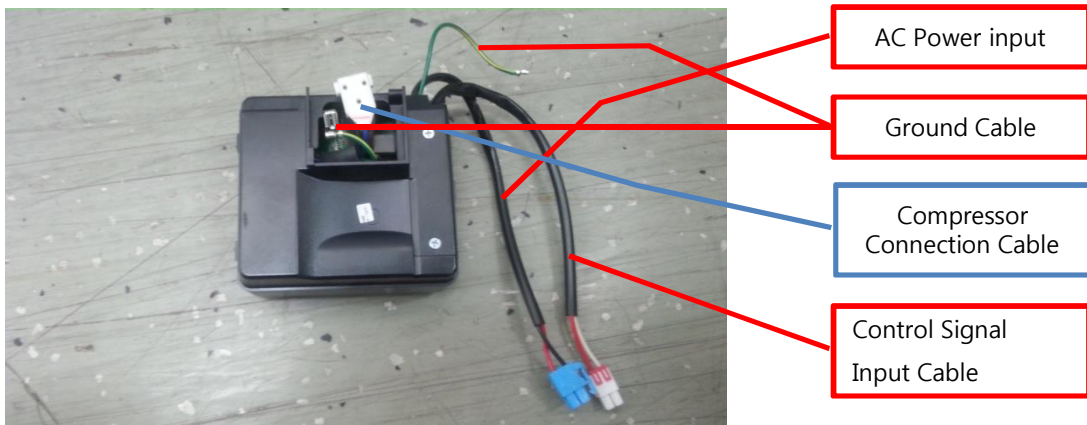

● Connection of INVERTER BOX & COMPRESSOR

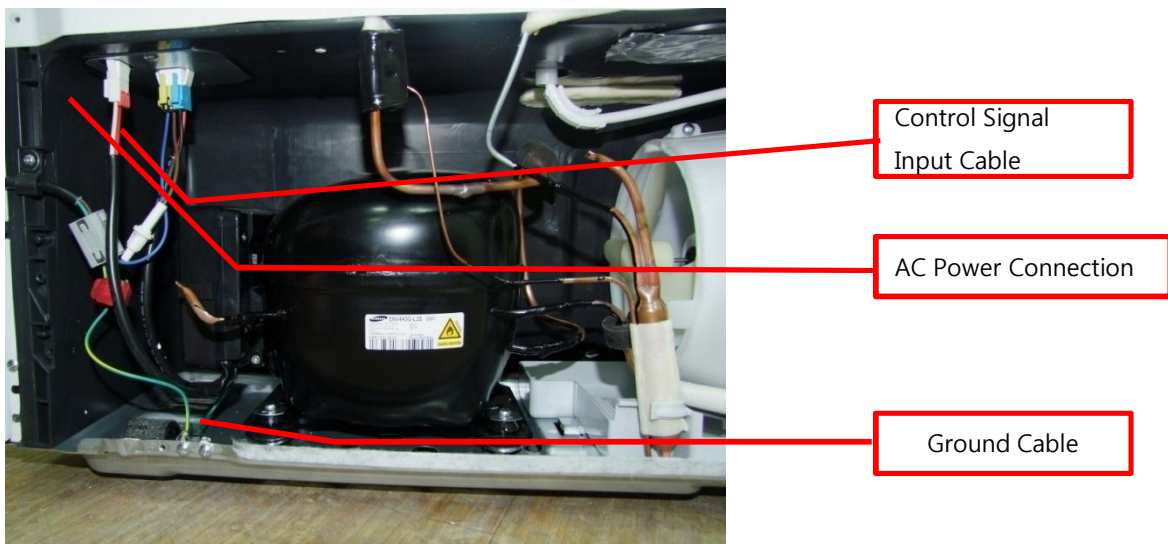

3-3) How to check bad COMP terminal of INVERTER COMPRESSOR

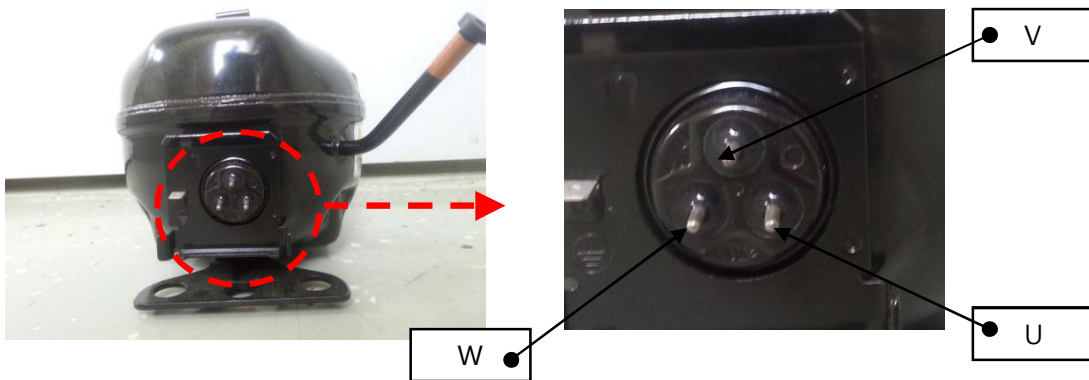

● COMP or Resistance value CHECKING

- > Resistance value on V = on W + on U
- > Resistance value on W = on V + on U
- > Resistance value on U = on W + on V

=> Normal: Resistance values on W, V, U agree with each other.

=> Abnormal: Resistance values on W, V, U do not agree with each other.

Average Resistance Value (at Room Temperature)			
COMPRESSOR	On V (Ω)	On W (Ω)	On U (Ω)
VESD11C	9.4	9.4	9.4
ENV4A5G-L2B	9.5	9.5	9.5

● Note

The higher the temperature of the coil of the motor is, the larger the resistance will be.
(If power is normally supplied, it means COMP state is good.)

3-4) How to Check Inverter Input Signal

● Inverter Input Signal Waveform section CHECKING







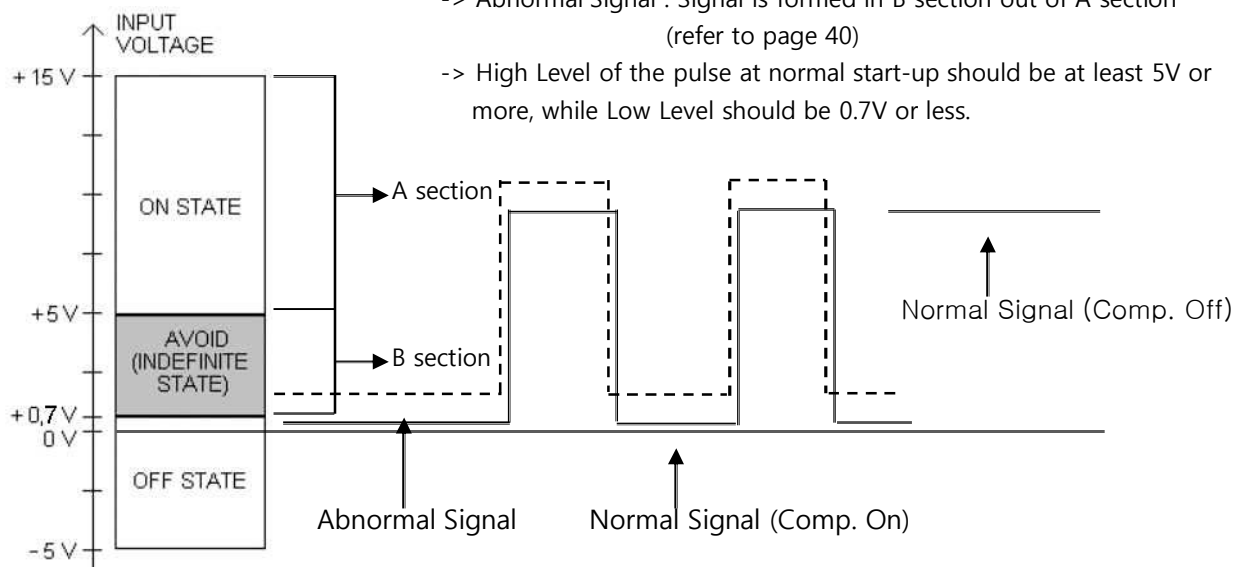



-> Normal Signal : Signal is formed at A section

-> Abnormal Signal : Signal is formed in B section out of A section
(refer to page 40)

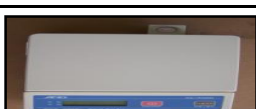

-> High Level of the pulse at normal start-up should be at least 5V or more, while Low Level should be 0.7V or less.



7-10-3. CYCLE(R-600a) Repair Tool Set Guide

No.	Tool Name	Image	No.	Tool Name	Image
1	Tap Plier		6	Can Adaptor	
2	Pinch Plier		7	Vacuum Pump	
3	Electronic Scale		8	Refrigerant Discharge Hose	
4	Gas Leakage Detector		9	Charging Ripple (For Gas Injection)	
5	R-600a Refrigerant Can		10	Welding Machine	



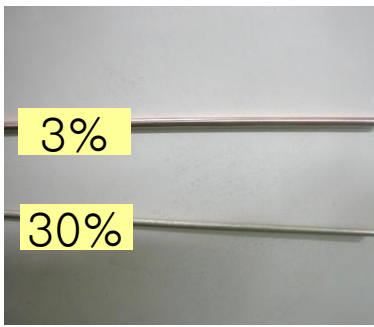

7-10-4. CYCLE(R-600a) Repair Preparation Materials

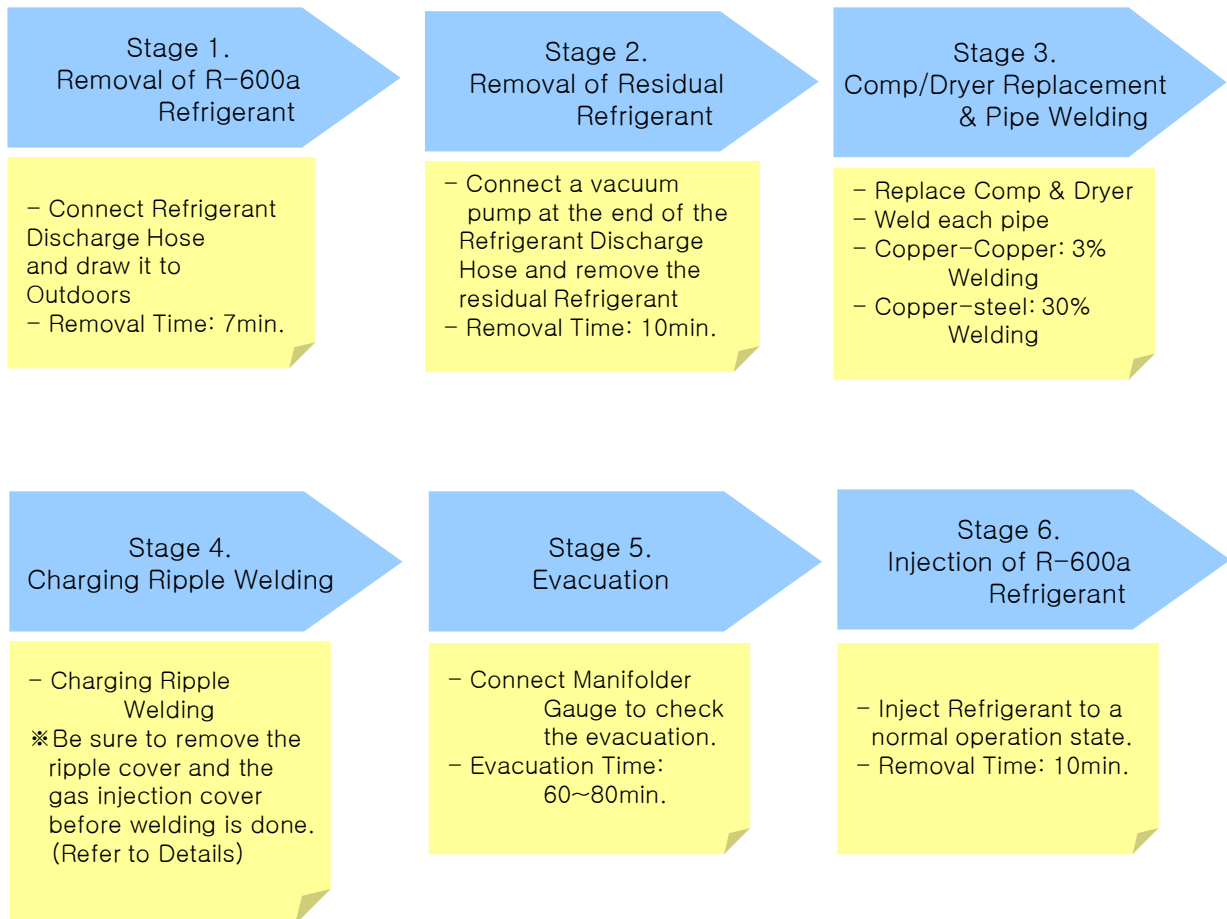

1. COMPRESSOR	2. DRYER	3. Welding Rod
		

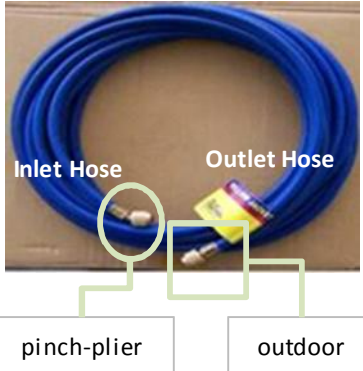

7-10-5. Order of CYCLE(R-600a) Repair Work (COMP Replacement)





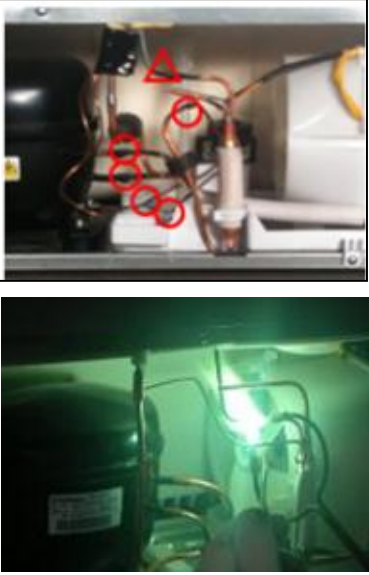

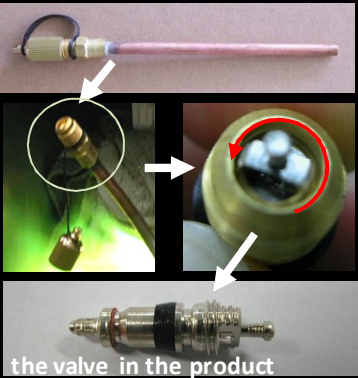

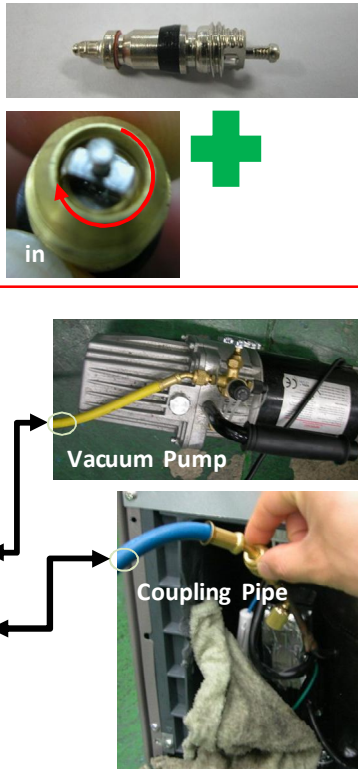

CYCLE(R-600a) Detailed Repair Stage

NO	SVC process	Image	Details
1	<p align="center">Connect the Pinch-plier & Discharging Hose</p>		<ul style="list-style-type: none"> - Connect the inlet of discharging hose to the pinch-plier. - The outlet of discharging hose should be placed to the outdoor
2	<p align="center">Fix the Pinch-plier & Charging Pipe</p>		<ul style="list-style-type: none"> - Fix the pinch-plier to the compressor charging pipe(=Process Pipe). - Pinch-plier should not be moving freely. ▪ If that is moving freely, it would cause fire, explosion as leakage gas in the room.
3	<p align="center">Remove Refrigerant R600a 87%</p>		<ul style="list-style-type: none"> - Discharge Refrigerant R600a (flammable gas) to outside of a room, before connecting the vacuum pump. ▪ It should have enough time more than 7 minutes to discharge.
4	<p align="center">Remove Refrigerant R600a 100%</p>		<ul style="list-style-type: none"> - Connect the vacuum pump to the outlet of discharging hose. ▪ Vacuum pump should be placed at the outdoor which has good ventilation. ▪ It should have enough time more than 10 minutes to form a vacuum.

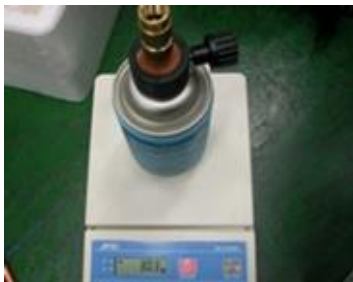
NO	SVC process	Image	Details
5	<p align="center">Separate Pinch-piler & Pipes</p>		<ul style="list-style-type: none"> - Separate parts of the refrigerating circuit (del-pipe, suc-pipe conn, capillary pipe, dryer & hot pipe, etc.) ▪ Caution: Be careful no parts are damaged by welding flame.
6	<p align="center">Change the Compressor & Dryer</p>		<ul style="list-style-type: none"> - Change the compressor and dryer. ▪ Check the compressor specification and use same one.
7	<p align="center">Weld</p>		<ul style="list-style-type: none"> - Weld pipes. ▪ Copper Welding: Ag 3% [○] (copper and copper) ▪ Silver Welding: Ag 30% [△] (copper and steel, steel and steel)

NO	SVC process	Image	Details
8	<p style="text-align: center;">Avoid Damage of Coupling Pipe by Welding Heat</p>	 <p style="text-align: center;">the valve in the product</p>	<ul style="list-style-type: none"> - Unscrew the cap on the coupling pipe. - Unscrew the valve in the product counter clockwise like the direction of arrow in the left picture. ▪ To prevent the packing rubber of the valve in the product from welding heat.
9	<p style="text-align: center;">Weld Coupling Pipe</p>		<ul style="list-style-type: none"> - Weld after inserting the coupling pipe to the compressor. ▪ Please wrap the parts inside of machine room with wet clothes for no damage.
10	<p style="text-align: center;">Reassemble Valve of the Coupling Pipe & Connect Gauge</p>	 <p style="text-align: center;">Gas Manifold Gauge</p> <p style="text-align: center;">Vacuum Pump</p> <p style="text-align: center;">Coupling Pipe</p>	<ul style="list-style-type: none"> - Assemble the valve in coupling pipe to clockwise. - Connect hoses of the gas manifold gauge to the coupling pipe and vacuum pump. - Open the gauge lever and operate the vacuum pump.

NO	SVC process	Image	Details
11	Vacuum		<ul style="list-style-type: none"> - Form a vacuum with pump. ▪ Surely perform the pump for 60~80 min. ▪ If the vacuum time is less than 60min, coefficient of performance of the refrigerator and air cooling would be weak.
12	Check the Pressure	 	<ul style="list-style-type: none"> - Check the gauge scale: -76cmHg (at the standard atmospheric pressure) ▪ If not, it could be leakage problem. <p>The pressure could change according to altitude and air temperature.</p>
13	Adjust the amounts of refrigerant	  	<ul style="list-style-type: none"> - Measure weight of R600a can with scales and discharge the surplus refrigerant. ▪ For your safety, work in the fresh air. ▪ Tip of adjusting: - Check the amount of refrigerant used for refrigerator. (ex: 64g) - Check the volume of the can label. (ex: 85g) - Calculate the amounts of discharging. (ex: 85g-64g=21g) - Weigh can attached adapter on the scales. (ex: 160g+145g=305g) ∴ Discharge the refrigerant until the scales at 284 grams. (305g-21g=284g)

NO	SVC process	Image	Details
14	<p align="center">Connect Coupling Pipe & Can Adapta</p>		<ul style="list-style-type: none"> - Connect can adapter to the coupling pipe. - Open adapter lever slowly and charge the refrigerant R600a. ▪ Refrigerant must not leak in the room.
15	<p align="center">Charge Refrigerant</p>		<ul style="list-style-type: none"> - Operate the compressor of the refrigerator and then start to charge the refrigerant more than 10 min. ▪ How to know end of charging: Dew around can goes away.
16	<p align="center">Leakage Test (Welding area)</p>		<ul style="list-style-type: none"> - Check the leakage with gas leakage inspector. ▪ When the leakage is detected, you must rework from the first step.
17	<p align="center">Finish work</p>		<ul style="list-style-type: none"> - Clean and clear around the rear of the refrigerator after finishing all steps. - Assemble the machinery room cover. - Try to keep our customers satisfied. - You did a great job.

7-10-6. Notes on CYCLE(R-600a) Repair

Item	Notes
Refrigerant R-600a Characteristics	1) R-600a Refrigerant is a nonpolar natural gas Refrigerant (C ₄ H ₁₀). 2) R-600a Refrigerant is the same series as Butane with a risk of explosion when it is discharged to a certain concentration. 3) It requires great care in CYCLE mid-repair.
Place and Environment of CYCLE Repair	1) Check if the air circulation and ventilation of the place are good. 2) Be sure to use a Refrigerant recollection bag indoors. 3) If there is a flame or a heat source around the place, remove them. 4) Be sure to avoid discharging Refrigerant as it is very flammable. 5) Be sure to follow the mid-repair SVC procedure in the work.
Tool Use	1) The Refrigerator use R-600a for its Refrigerant, so use exclusive parts and tools for it
Residual Refrigerant Removal	1) When removing Residual Refrigerant, be sure to wait 5min. or longer after the refrigerator power is off before the removal. 2) In the removal, cut the high-pressure side first and the low-pressure side next 3) In case of a dry blockage, cut the capillary pipe to remove the Refrigerant.
Dryer replace	1) When repairing pipes or injecting refrigerant, be sure to replace dryer with one for R-600a.
Nitrogen-BLOWING Welding	1) While welding, blow nitrogen with a constant pressure in the pipe to prevent oxidation scale occurring (Nitrogen pressure: 0.1~0.2 kgf/cm ²)
Others	1) Use nitrogen gas in cleaning the inside of the cycle piping. 2) Conduct a leakage test using an electronic leakage detector. 3) When cutting the pipe, be sure to use a pipe cutter. 4) Be careful not to allow any moisture inside the cycle. 5) When the Refrigerant is leaked, never use welding machine nor a flame source. 6) Personnel other than those who took indoctrination shall never be allowed to perform R-600a mid-repair. 8) Conduct leakage test thoroughly after a repair. 9) Never do a welding nor allow a fire source in after Refrigerant is sealed in.

8. Response to Complaints to Emotional Quality

8-1. Temperature

Contents of Complaints	Explanation & Actions
Bad fridge function	Generally the refrigerator is shipped in a 'Medium' setup, while the customer may change the temperature inside the compartments in accordance with the usage environment or condition. Some customers complain about the change of the dial, but we cannot meet the needs of all the customers. Explain that we just selected typical groups of temperatures to set them as typical values while the dial may be moved to meet individual needs.
Fish melt which are kept in the meat container.	Meat container is where you can keep fish or meat for 1~2 days and where the temperature is maintained so that meat or fish cannot be kept long. Explain that you should keep the food in the Freezer in that case.
The refrigerator is weaker than the previous ones and less cool than others'.	If previous ones are small ones or of a mechanical type, it is a feeling coming from the enlargement of the product. If the storage period of food is not specifically shortened, it is more likely a mere feeling. Lead them to set the dial to 'strong'.
Water kept in the refrigerator is not cool.	Water is generally kept in the door pocket, but if the passage of the cool air in the compartment is blocked, coolness may not be transmitted smoothly. Lead them to move the food away from the outlet of coolness.
Ice cream melts.	The freezing temperatures of high-grade ice creams get lowered, so they will usually melt at -13°C or lower. Therefore, frequent opening of the door and others may make the ice cream melt. Lead them to move the ice cream deeper into the compartment or change the dial to 'strong'.
Kimchi melts.	Kimchi contains much moisture, so it is likely to freeze at a low temperature. When keeping Kimchi, put it away from the outlet of coolness. Particularly, if large boxes of food block the outlet, the temperature in the pocket may get higher.
Vegetable melts.	As vegetable contains much moisture, it is likely to freeze with a little coolness passing by. So unless you keep it in the exclusive vegetable room, it may easily freeze.
Too strong fridge function	If the water or food kept in the Fridge freezes, lead the customer to set the dial to 'weak'. If only the food in front of the outlet of the coolness freezes, lead them to change the location of the food.

8-2. Noise

Contents of Complaints	Explanation & Actions
Buzzing noise	<p>A refrigerator has driving sources that can cause noise, such as the Comp, the Freezer fan and the machine room fan. The states of these driving sources will vary in accordance with the surroundings and the customer's usage condition, by which the operational noise may be felt strong.</p> <p>(Ex: When initial power is supplied, the Freezer fan and the Comp will rotate in a high speed.)</p> <ul style="list-style-type: none"> - Freezer fan <p>It is in the Freezer and circulates coolness in the compartment. When the fan runs, the coolness may pass through narrow passages, producing blowing noise or vibration.</p> <ul style="list-style-type: none"> - Machine room fan <p>It is in the machine room in the rear of the refrigerator and it cools the machine room. If you place the refrigerator too close to the wall, there may arise a resistance in the circulation of the air, amplifying the buzzing noise.</p> <ul style="list-style-type: none"> - Comp <p>It is the one of the noisiest source of noise in the refrigerator and rotates in a high speed to circulate the refrigerant.</p>
Rattling noise from the refrigerator	Such noise is from the contraction and extension of various parts of the Eva and pipes in the compartments by the change of temperature inside as the refrigerator runs.
Noise of streaming from the refrigerator	Such noise is from the high-pressure refrigerant of the Condenser flown down into the Eva when the refrigerator stops running.
Rumbling noise from the refrigerator	When the refrigerator stops running, liquid refrigerant is collected in the Eva Accum and the evaporated refrigerant from the OIL-collecting HOLE will pass through it. The sound occurs in this process.
Rattling and thumping noise from the refrigerator	Such noise is from the vibration of the motor or the piston of the Comp as it starts or stops running.
Booming noise from the refrigerator	<p>Such noise is from the pipes touching each other. Separate the touched points of the pipes or insert anti-vibration mass to remove the vibration.</p> <p>If it is from the evaporation container not fixed or partly touching the base of the Comp, use seal material to prevent the vibration.</p>
Others	If the refrigerator is installed with a bad horizontality, small noise may be amplified. So adjust the horizontality adjustment bolt so that the refrigerator may not be movable. If it is installed on a wooden floor or against a wooden wall, the noise may be amplified.

8-3. Odor & Frost

Contents of Complaints	Explanation & Actions
Much smell in the Fridge	Foods have various smell. Fermented foods especially popular in this country have their unique smells that are not easily gotten rid of. When there is strong smell, set the temperature in the compartment to 'strong' first and then wipe the inside surface of the compartment using cleaning products, such as Pongpong. Particularly, salted fish or various Kimchi with their container open or spilt on the shelf, etc. can cause much smell. And help the customers understand the need of regularly cleaning the inside of the refrigerator.
Frost in the Freezer	In one of the following cases, frost will suddenly occur: <ul style="list-style-type: none"> - The door is open - There is a gap in the gasket with air let in through it - You open the door of the Freezer too much - You put warm water in the Freezer without cooling it. Especially in summer, warm, wet air can flow into the Freezer and settle on the food, whenever you open it. These things happen temporarily, and will disappear if you reduce the accessing of the Freezer.
Frost occurs on the front part of the ice machine.	If you put the ice machine filled with water in the Freezer, there will occur much evaporation on the surface of the water. And when cool air is blown from the coolness outlet on the rear side, much frost will take place momentarily.

8-4. Others

Contents of Complaints	Explanation & Actions
The side of the refrigerator is hot.	On the front side and around, heat-releasing pipes are installed so as to prevent the dewing in the Freezer and the Fridge. Particularly in hot summer, or when the refrigerator is installed too close to a wall, it may get hot due to a poor heat release. Let there be good ventilation, then.
A hole inside the door	A small hole on the inside is a breathing hole to let the insulation spread well over the door during the insulation work. It is not a defect. Don't worry.
It is hard to open the door.	When you open the door, the cool air in the refrigerator meets the warm air from outside, when the air inside gets smaller in volume momentarily, forming a negative pressure. This is the same principle as when a PET bottle filled with warm water and put inside a refrigerator shrinks. It is normal.
The door is lifted, or budges, slightly.	The Freezer and the Fridge are interconnected through an air channel. So when you close a door, the air which has flown in moves to the other compartment through the channel and the air exceeding the volume of the compartment will leak out.

9. Disassembling & Assembling of Each Part

※ Follow the inverse order of the disassembling for an assembling

9-1. How to Replace the Light

Replacement of the Freezer LED

- ◆ Disassemble the Geared-Motor Box.
(Refer to 'Geared-Motor replacement')



Insert a (-)driver into the rear part of the LED cover at the bottom of the Geared-Motor Box and pull it toward the front to separate the LED cover.



After separating the LED cover, unwind the fixing bolts (2ea) on the LED board.



Separate the connection socket of the LED board and replace the LED.

Replacement of the Fridge LED



Insert a (-)driver into the rear part of the LED cover and pull it toward the front to separate the LED cover.

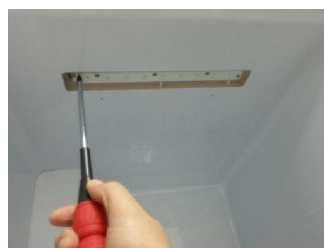

After separating the LED cover, unwind the fixing bolts (2ea) on the LED board.



Separate the connection socket of the LED board and replace the LED.

9-2. How to Replace Ice Machine/Geared-Motor /Water-supply Pipe

Replacement of the Ice Machine



Pull the ice shaver to the front, lifting its bottom a little, to separate it.



Hold the bottom of the ice machine cover and pull it toward the front to separate it from the Freezer.

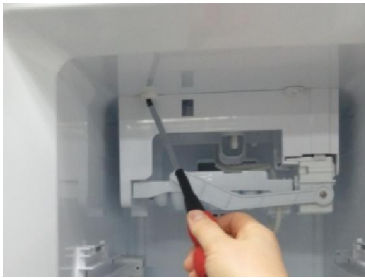

Unwind the bolts (2ea) fixing the ice machine on the ceiling of the Freezer and pull the ice machine to the front to softly lift it off.

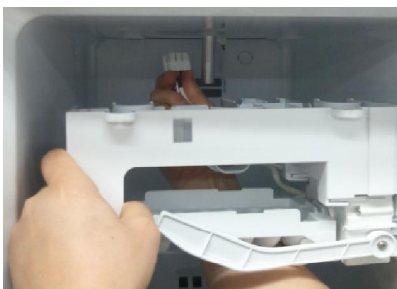
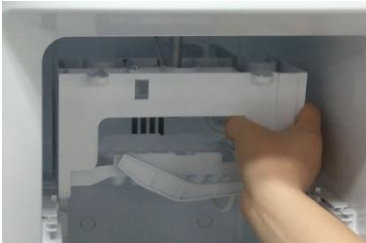

Separate the connection socket connected to the top of the Freezer and separate the ice machine from the Freezer.

Replacement of the Geared-Motor

◆ After separating the ice machine, separate the Geared Motor Box.



Separate the two connection sockets connected to the Geared-Motor Box at the top of the Freezer.



Unwind the fixing bolts (4ea) of the Geared-Motor Box and separate it from the Freezer.

Replacement of the Water-supplying Pipe

- ◆ Separate the ice machine from the Geared-Motor.



Separate the water-supplying Pipe heater connection socket.



Unwind the bolt of water-supplying pipe cover at the top of the refrigerator and separate the cover from the water-supplying outlet (silicon rubber).



Push up the water-supplying pipe out of the top of the Freezer and pull off the water supplying pipe at the top of the refrigerator.

9-3. How to Replace Freezer Condenser & Freezer Fan Motor

Freezer Condenser Replacement

- ◆ Take the food & the shelf out of the Freezer.
- ◆ Separate the ice machine from the Geared-Motor.



Separate the water-supplying pipe heater connection socket.



Unwind the fixing bolts (2ea each) of the geared motor guides fixed to the left and right side of the Freezer and separate them from the Freezer.



Unwind the fixing bolts (2ea each) of the ice shaver guides fixed to the left and right side of the Freezer and separate them from the Freezer.



Remove the Screw Caps (3ea) of the Freezer Louver F A.

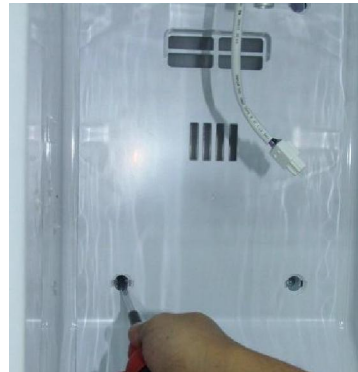

Unwind the fixing bolts (4ea).



Hold the frame around the coolness discharging outlet at the top of the Louver F A and pull it toward the front.

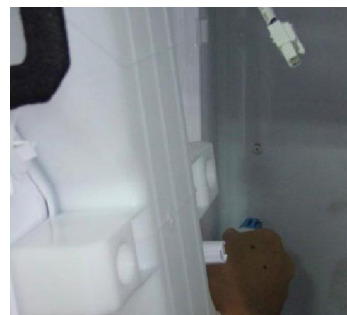

Turn the right part of the Louver F A toward the front direction, and separate the connection socket of the Louver F A connected to the inner board.



Separate the Louver F A from the Freezer.



Unwind the bolt (1ea) fixing the Louver F B to the Freezer.



Unwind the fixing bolt (1ea) of the return cover.



Separate the upper part of the Louver F B from the Freezer holding it and pulling it toward the front.



Lift up the return cover and separate it from Louver F B. Then, pull it out of the Freezer.



The shape of the Freezer condenser



Separate the lower part of the Louver F B from the Louver F B, holding it and pulling it toward the front.

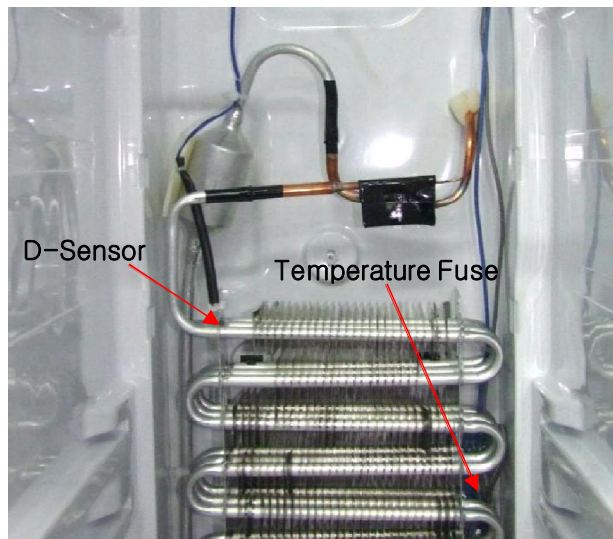
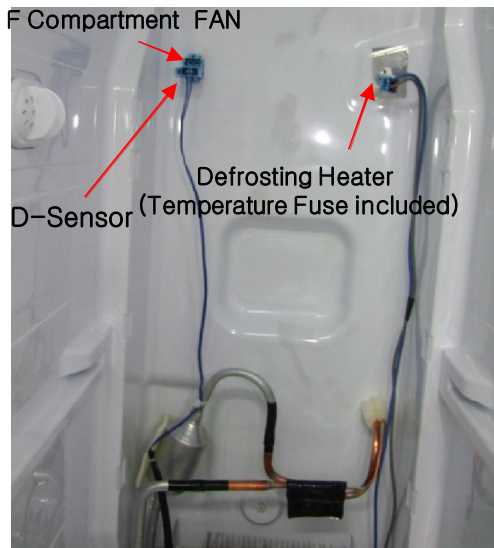

[Location of Connection sockets of Freezing Compartment Electronic Units]

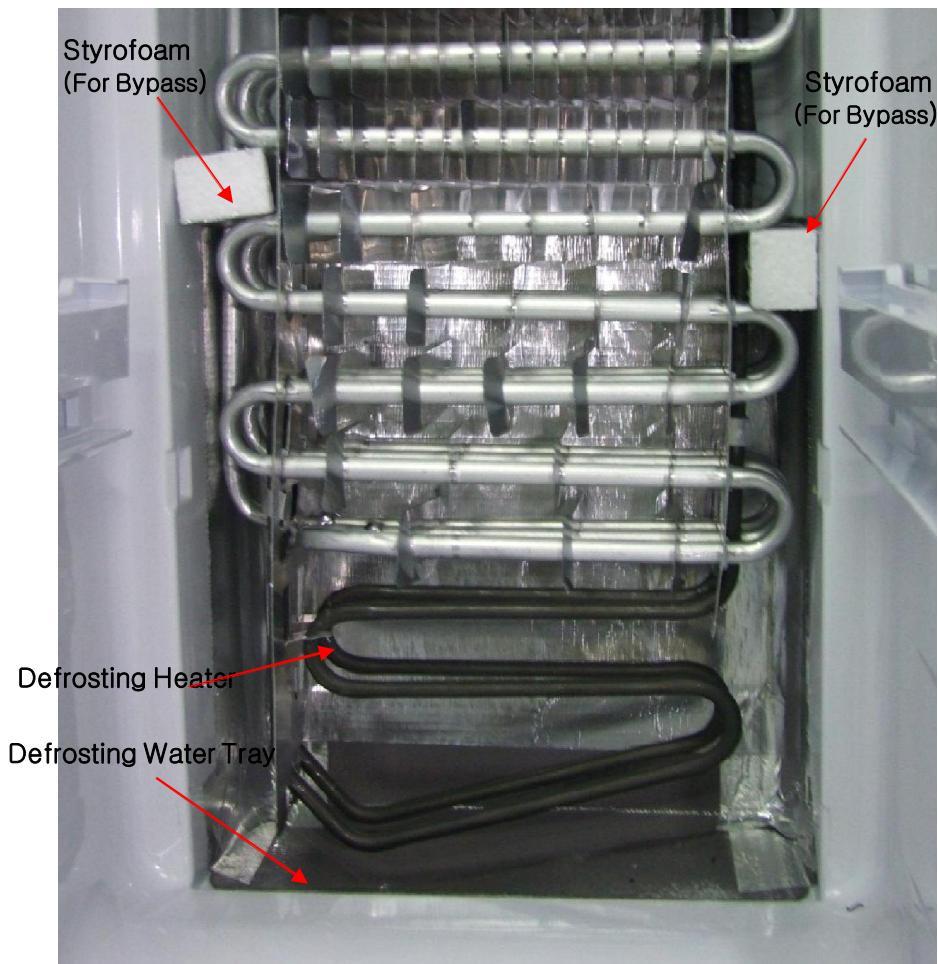

Freezer Fan Motor Replacement

- ◆ Separate the Louver F A.
(Refer to the Freezer Condenser Replacement Method)



Unwind the Louver F C fixing bolts (3ea).



Release the temporary hook of the Louver F A to separate the Louver F C.



Unwind the fixing bolts (4ea) of the Motor fixing holes.

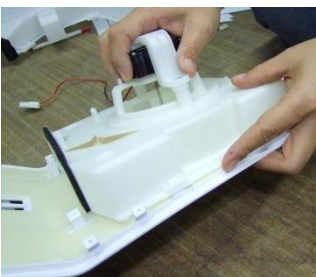

Release the temporary hook of the Louver F A to separate the Motor fixing holes.

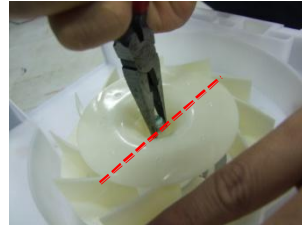

Separate the Spring from the Fan, using the tool.
(Note the direction of the tool)

[Agreement of the directions of the tool & Fan Shaft]



Separate the Fan from the Motor fixing Holes, using the tool.
(Note the direction of the tool)

[Agreement of the directions of the tool & Fan Shaft]

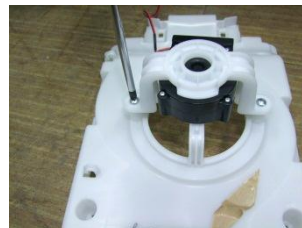

Unwind the fixing bolts (2ea).



Separate the Fan Motor from the Motor fixing hole.

Note on FAN & FAN MOTOR Disassembling/Assembling

- MOTOR shall be fixed so that it is not slanted or loose (for the sake of the noise)
- Fix the FAN with the fan-fixing ring so that it is not movable, and apply Locktight(adhesive).
- After fixing the FAN, check if it does not touch surrounding parts by turning it with your hand.
If it does, re-fix the MOTOR or the FAN.

9-4. How to Replace Freezer Damper Cover & Damper

- ◆ Take the food & the shelf out of the Freezer.

Damper Cover Replacement



Unwind the bolt (1ea) on the side of the Damper.



Draw the Damper cover obliquely (to the direction of the arm) to separate it from the refrigerator.

Damper Replacement

- ◆ Separate Damper Cover first.



[Damper Mounting]



Separate the connection socket of the Damper.



Separate the Damper from the Freezer.

9-5. How to Replace the C-Fan Motor



C-Fan Motor Housing

Bellmouth

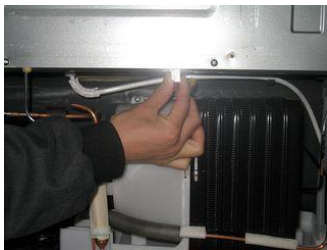

Separate the C-Fan Motor connection socket at the top to the right side of the machine room.



Draw the the Bellmouth toward the front, pressing Lock of the Bellmouth, to separate the Bellmouth Ass'y. (In separating it, take care not to have the fan blades deformed.)

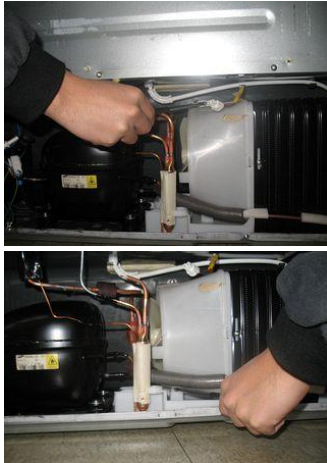

Unwind the bolts at the top and bottom of the Bellmouth.



Separate the Fan blades from the C-Fan Motor Shaft.



Push the Dryer in front of the Belmouth toward the Comp slightly to make room to pull off the Bellmouth.



Unwind the bolts of the Motor Cover, and separate the Cover before pulling out the C-Fan Motor.

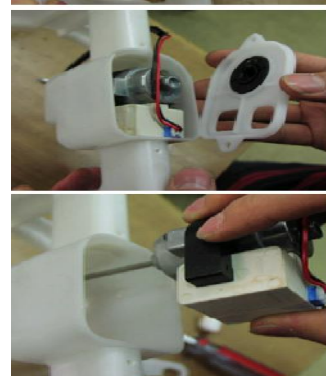

9-6. How to Replace the Front PCB

- ◆ Be sure to disconnect the power supply, before starting the work.

Front PCB Replacement



Unwind the bolts at the bottom of the FCB of the Freezer Dispenser.



Hold the FCB of the Freezer Dispenser with your two hands and pull it to the 7 o'clock direction to separate it.



Separate the socket connected to the FCB.

9-7. How to Replace the Dispenser Part LED

- ◆ Dispenser Part LED is combined into the Front PCB.
- ◆ Dispenser Part LED shall be replaced by the replacement of the Front PCB.

9-8. How to Replace Dispenser Section Flap Lever / Dispenser Lever / Ice Shutter

◆ Be sure to disconnect the power supply before starting the work.

Separation of the ICE SHUTTER BOX

◆ Disassemble the Front PCB.



Pull out the water hose from the fixture of the I/SHUT BOX.



Unwind the fixing bolts (4ea) of the Dispenser Section I/SHUT BOX.



Separate the sockets (2ea) connected to the microswitch attached to the I/SHUT BOX, and pull the harness off the harness holder.



Separate the socket connected to the FLAP Heater fixed to the I/SHUT BOX.



Separate the Socket connected to the Ice Shutter fixed to the I/SHUT BOX.



[Separated I/SHUT BOX]

Flap Heater Replacement

- ◆ Disassemble the ICE SHUTTER BOX.



Separate the silicon rubber of the Flap Lever.



Take out the pad inside the Flap Lever.



Pull the Heater off Flap Lever.

Microswitch Replacement

- ◆ Disassemble the ICE SHUTTER BOX.



Pull off the Microswitch by opening the fixing hook of the I/SHUT BOX.

Ice Shutter Replacement

- ◆ Disassemble the ICE SHUTTER BOX.



Unwind the fixing bolts (3ea) of the Ice Shutter.



Pull out and separate the Ice Shutter inserted in the Rotation Axis of the Flap Lever.

Flap Lever Replacement

- ◆ Disassemble the Ice Shutter.



Separate the Flap Lever Rotation Axis from the Ice Shutter and pull it to the direction of the arrow to separate it from the I/SHUT BOX.



Take the Flap Lever Rotation Axis (Spring interposition) out of the I/SHUT BOX.

Dispenser Lever Replacement

- ◆ Disassemble the Dispenser Guide.



Pull the Dispenser Lever toward the Flap Lever, and take the Display out of the I/SHUT BOX.



Pull the Rotation Axis of the Dispenser Lever toward the direction of the axis, and take it out of the I/SHUT BOX.

9-9. How to Replace the Door of the Home-bar



Open the Home-bar Door and separate the Cover at the bottom, using a (-)Driver.



Insert the (-)Driver to the Shaft Head and pull it, holding the Home-bar Door with one hand.



If you move the shaft by a certain distance, the Door will be separated.



Separate the Home-bar Door from the refrigerator by orderly twisting it from its left side.

◆ Disassemble the Home-bar Door.

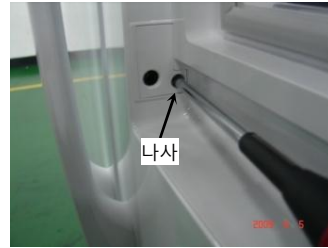

Unwind the fixing bolt of the Cover Damper.



After unwinding the bolt, pull the Cover Damper to the direction of the arrow, using a tool to separate it.



Separate the Damper-fixing bolts.



Separate the Damper Supporter, using a knife blade, as in the picture.



Separate the Damper.

※ Separate the Damper on the right side in the same way.

Home-bar Frame Ledge Replacement



Open the Home-bar Door and unwind the fixing bolts of the Ledge Cover at the top.



Separate the Ledge Cover.



Remove the fixing bolt of the Ledge.



Separate the Ledge from Home-bar frame.

The Home-bar Door Switch Replacement

- ◆ Separate the Ledge Cover.
 - Refer to the Home-bar Frame Ledge Disassembling Method.



Make the Home-bar Door Switch protrude out of the fixing hole.



Hold the Lead Switch Socket with a hand.



Separate the Socket.

9-10. How to Replace the Door Switch / Humidity Sensor

Replacement of the Door Switch



Disassemble the fixing bolts(2ea) of the Hinge Cover.



Open the Door and disassemble the Hinge Cover, lifting it from the back of it.



Separate the Door Switch, pressing the round swelling part of the Door Switch.



Separate the Harness connected to the Door Switch.

Humidity Sensor Replacement

◆ Disassemble the Fridge Hinge Cover.
(Separate the Humidity Sensor connection socket from the Door Switch)



[Separated Fridge Door Switch]



Take out the Humidity Sensor to the direction of the arrow, lifting it up.

※ The Door Switch Disassembling Method is the same with those of the Fridge and the Freezing Compartment.

9-11. How to Replace the Main PCB

- ◆ Be sure to disconnect the power supply before starting the work.

Main PCB Replacement

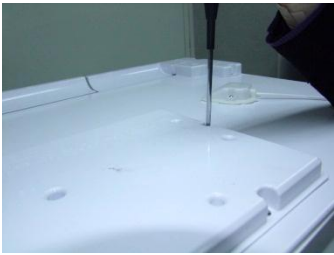

Separate the fixing bolts (4ea).

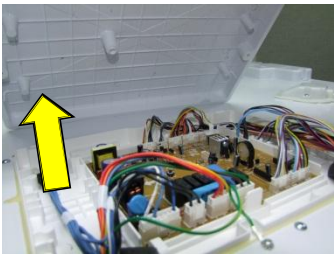

Separate the Main PCB Cover by pushing it to the Door (to the direction of the arrow).



Pull the connection sockets off the Main PCB.

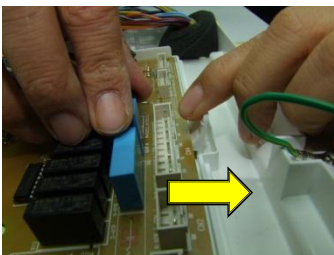

Press the temporary Hook to the rear panel (to the direction of the arrow) and separate the Main PCB board, and pull it to the rear panel (to the direction of the arrow) to take off the Main PCB.

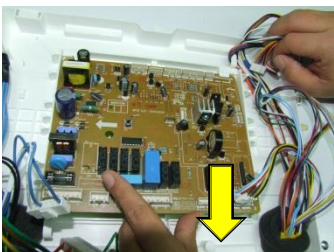

10. How to Install the Refrigerator

10-1. Preparation for the Installation

Check the following things to see if Refrigerator will pass the door

MODEL	Product Size (W X D X H)
Q Series	912mm X 741.3mm X 1771mm (Handle included)

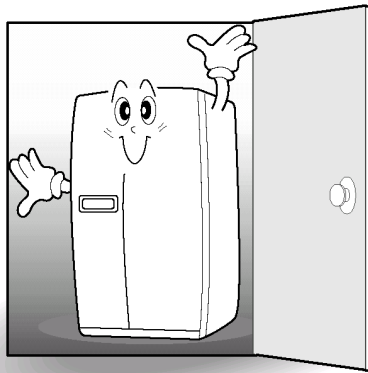

Choice of Place for the Installation

※ Maintain proper distance from the wall for a good ventilation

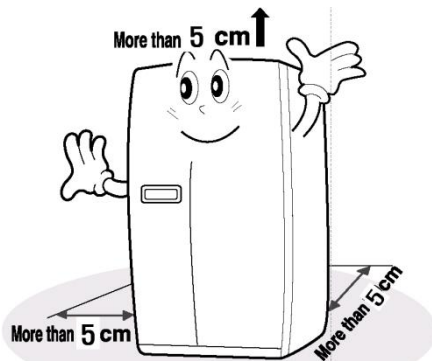

※ Direct sunlight shall be avoided

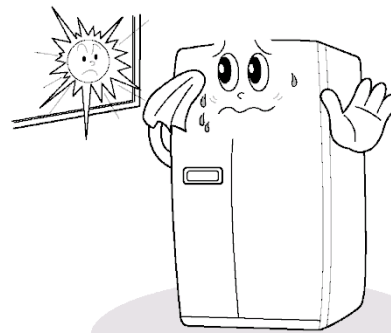

If the proper place for installation is prepared, the installation shall be proceeded in accordance with the procedure of the next page.

If the temperature is too low around the refrigerator (5°C or below), food may freeze, or the refrigerator may not work normally.

10-2. When the Refrigerator does not Enter the Door

Disassembling of the Freezer Door

◆ Remove the Front Panel first.

1 After the front panel is removed,, open the door and unwind the fixing bolts of the water-supplying hose connected to the door.



2 Pull off the fitting for connection between the hoses. Draw the connected hose off, pulling the end of the fitting to the direction of the fitting..



3 Separate the fixture for the bending of the hose fabricated onto the water-supplying hose on the door side.



4 For general models of products, the disassembling shall be proceeded in the same way as #1~4. (Lift the door until the water-supplying hose is pulled off to separate the door.)



5 Unwind the bolts(2ea) fixing the Upper Hinge Cover, using a driver, and push aside the side of the Upper Hinge Cover, before disassembling the Cover.

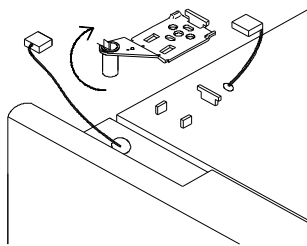

6 Unwind the bolt fixing the Upper Hinge counterclockwise, and pull off the wire connection Housing.

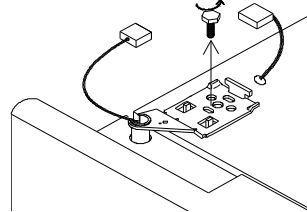

7 Separate the Upper Hinge, lifting it. (Take care lest the door fall down.)

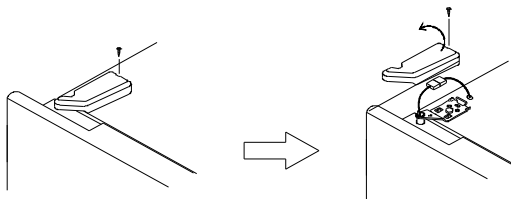

8 Lift the Freezer Door a little to separate the Door from the lower Hinge.

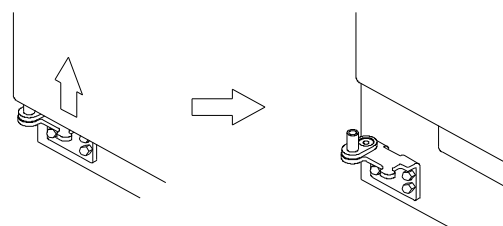

Disassembling of the Fridge Door

- 1** Unwind the bolts(2ea) fixing the Upper Hinge Cover, using a driver, and push aside the side of the Upper Hinge Cover before disassembling the Cover.

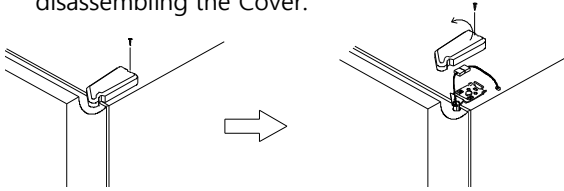

- 2** Unwind the bolt fixing the Upper Hinge Counterclockwise, and pull off the wire connection Housing.

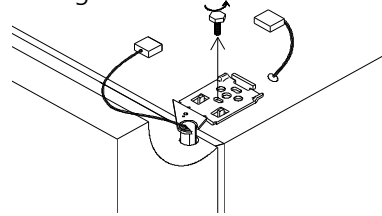

- 3** Separate the Upper Hinge, lifting it. (Take care lest the door fall down.)

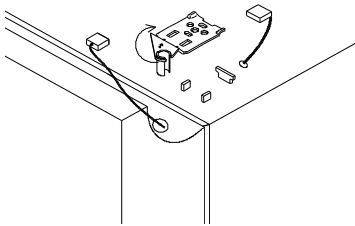

- 4** Lift the Freezer Door a little to separate the Door from the lower Hinge.

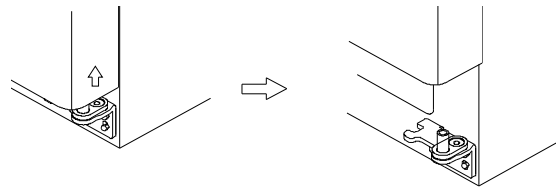

Assembling of the Freezer Door

- 1** Insert the Water-supplying Hose of the Freezer Door into the Lower Hinge and assemble the Door onto the Lower Hinge.



- 2** Insert the Upper Hinge onto the Hinge Hole on the Door and assemble, pushing the Freezer Door close to the direction of the arrow.

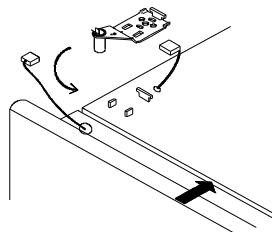

- 3** Turn the fixing bolt of Upper Hinge clockwise to fix the Door, and connect the wire-connection Housing.

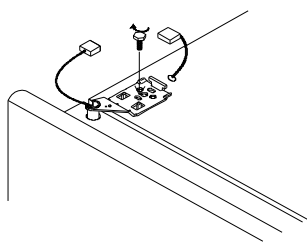

- 4** Assemble the Upper Hinge Cover onto the Upper Hinge so that it will fit into it with a snapping sound, and fix the fixing bolts (2ea).

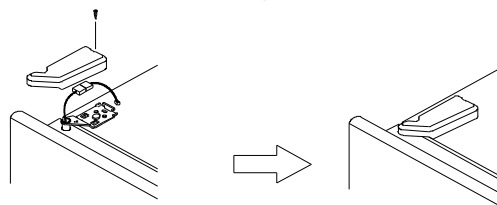

- 5** Assemble the fixture for the bending of the water-supplying hose onto the lower end of the door water-supplying hose and connect the hose with a hose-connection fitting. For connection, push the hose into the fitting, when you should push the hose into the fitting as much as you can.



- 6** Fix the water-supplying hose-connecting piece (the fitting piece) with bolts.



Assembling of the Fridge Door

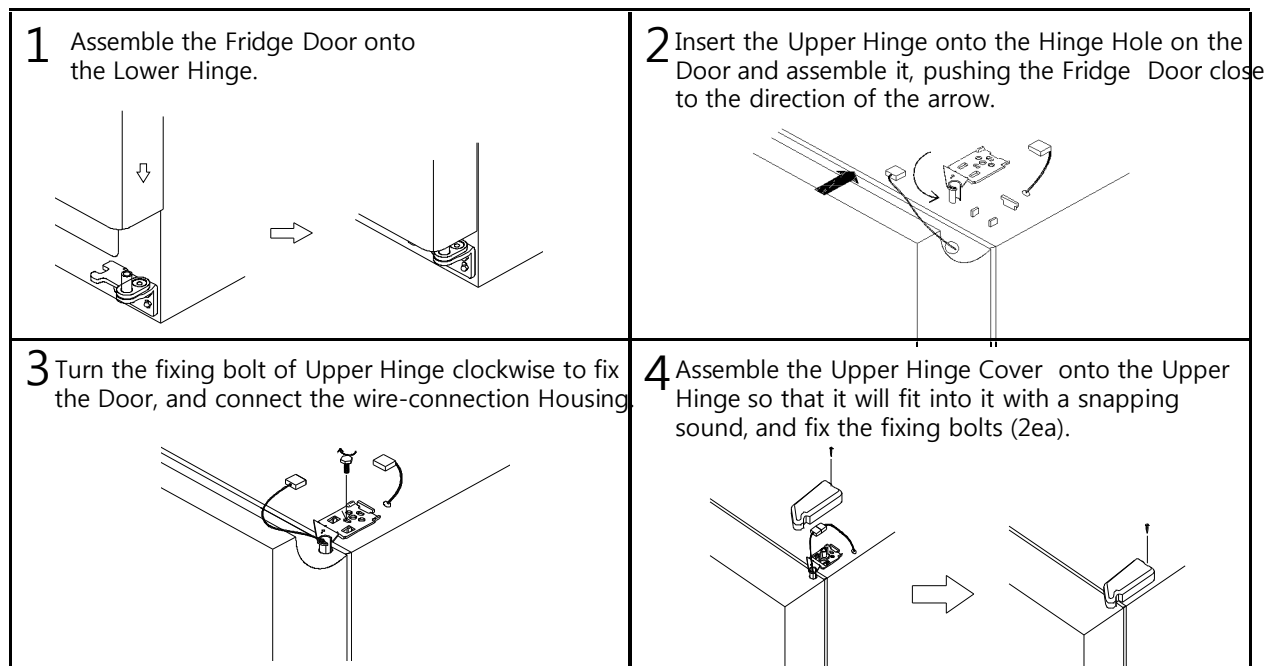

Assembling of the Front Panel Cover

※ Fix the Front Panel Cover with three bolts to the direction as shown in the picture.

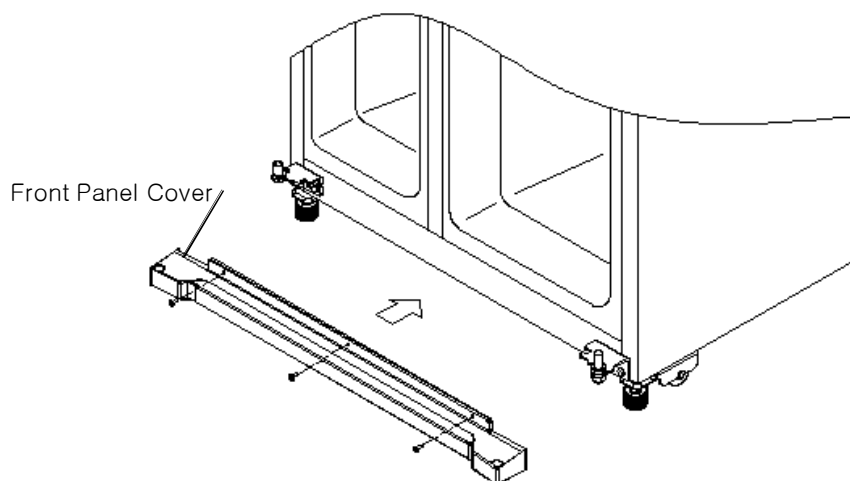

10-3. Refrigerator Height & Horizontality Adjustment

※ For the optimum appearance and performance of the refrigerator, its height should be adjusted well. (If the floor the refrigerator is irregular, the doors of the Freezer and the Fridge will look unbalanced.)

<p>If the door of the Freezer is lower than that of the Fridge.</p>	<p>If the door of the Fridge is lower than that of the Freezer.</p>
<p>Insert a (-)driver into the groove of the adjustment foot on the Freezer and turn it to the direction of the arrow to adjust the Horizontality.(Turn it clockwise to heighten the Freezer door, and turn it Counterclockwise to lower the door.</p>	<p>Insert a (-)driver into the groove of the adjustment foot on the Fridge and turn it to the direction of the arrow to adjust the horizontality. (Turn it clockwise to heighten the fridge compartment door, and turn it counterclockwise to lower the door.</p>



Caution

The front section of the door need be a little higher than the rear part so that the doors can easily be closed. But if the front section gets too higher while you adjust the door balance, it will be hard to open the doors.

Adjustment of the Lower Hinge height: when the height difference between the Freezer Door and the Fridge Door is severe

※ When it is difficult to correct the height difference of the Freezer Door and the Fridge Doors by adjusting the adjustment feet, the adjustment of the lower Hinge height is necessary as following.

- When the Fridge Door is lower than the Freezer Door

1. Insert a (-)driver into the groove on the adjustment foot on the Fridge and turn it to the direction of the arrow to adjust the horizontality.

* When the horizontality cannot be adjusted by turning the adjustment foot, adjust the horizontality as follows:

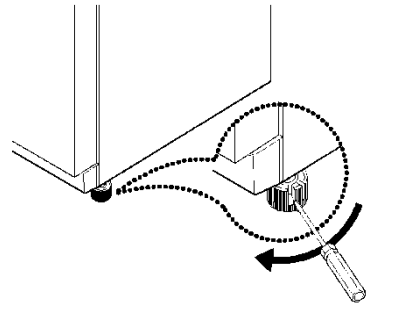

2. Open the refrigerator doors and separate the front panel cover from the refrigerator (when it is moved after having been installed).

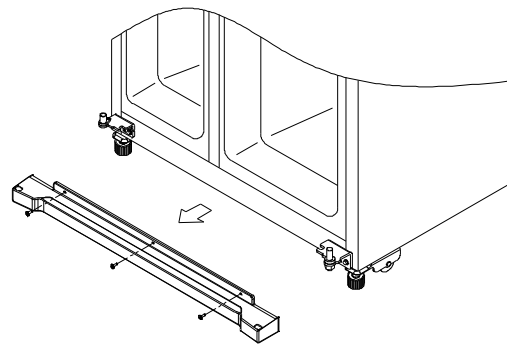

3. Put the 'A' part of the wrench onto the nut(1) of the door hinge on the Fridge and turn it clockwise to unwind the nut.

4. Put the 'B' part of the wrench onto the lower hinge shaft(2) on the Fridge and turn it counterclockwise to heighten the door of the Fridge.

5. Put the 'A' part of the wrench onto the nut(1) of the hinge and turn it counterclockwise to tighten it hard.

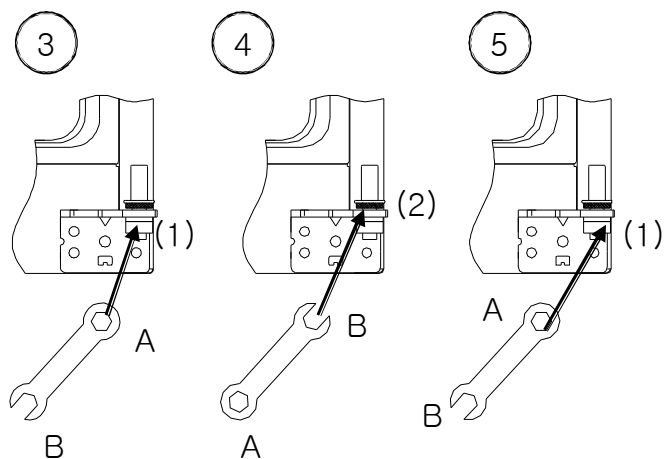

● When the Freezer Door is lower than the Fridge Door

1. Insert a (-)driver into the groove on the adjustment foot on the Freezer and turn it to the direction of the arrow to adjust the horizontality.

* When the horizontality cannot be adjusted by turning the adjustment foot, adjust the horizontality as follows:



2. Open the refrigerator doors and separate the front panel cover from the refrigerator (when it is moved after having been installed).



3. Put the 'A' part of the wrench onto the nut(1) of the door hinge on the Fridge and turn it clockwise to unwind the nut.

4. Put the 'B' part of the wrench onto the lower hinge shaft(2) on the Fridge and turn it clockwise to lower the door of the Fridge.

5. Put the 'A' part of the wrench onto the nut(1) of the hinge and turn it counterclockwise to tighten it hard.

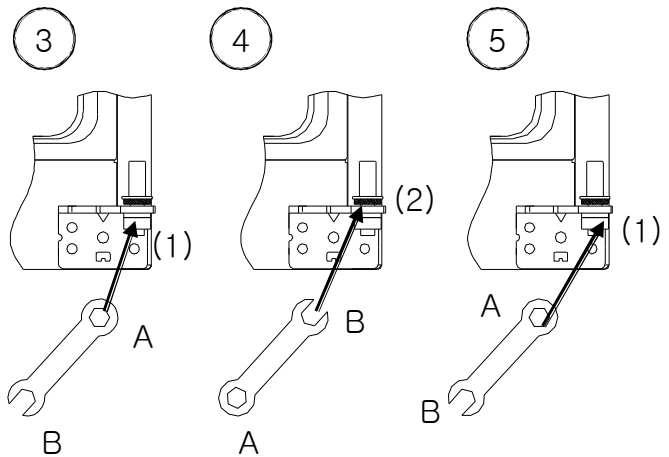
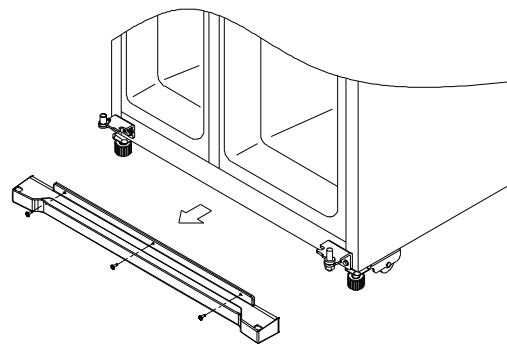
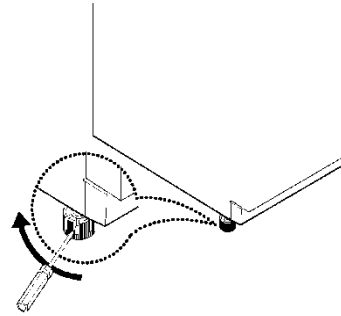

10-4. How to install Water Line (Dispenser Models only)

- The water pressure should be 2.0~12.5 kgf/cm² or more to run the automatic icemaker.
Checkup your tap water pressure ; if a cup of 180cc is full within 10 seconds, the pressure is OK.
- When installing the water tubes, ensure they are not close to any hot surfaces.
- The water filter only filters water ; it does not eliminate any bacteria or microbes.
- If the water pressure is not so high to run the icemaker, call the local plumber to get an additional water pressure pump.
- The filter life depends on the amount of use. We recommend you replace the filter at least once every 6months.
※When attaching the filter, place it for easy access (removing & replacing)
- After installation of refrigerator and water line system, select [WATER] on your control panel and press it for 2~3 minutes to supply water into the water tank and dispense water.
- Use sealing tape to every connection of pipes/tubes to ensure there is no water leak.
- The water tube should be connected to the cold water line.

External Filter Type

WATER SUPPLY KIT

- ※Check the parts below for installing water supply.
Some other necessary parts are available at your local service agents.

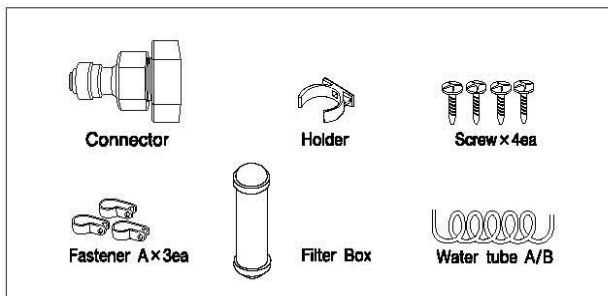

Installation Procedure (Dispenser Models Only)

1. Join Connector to the tap water line

Figure A

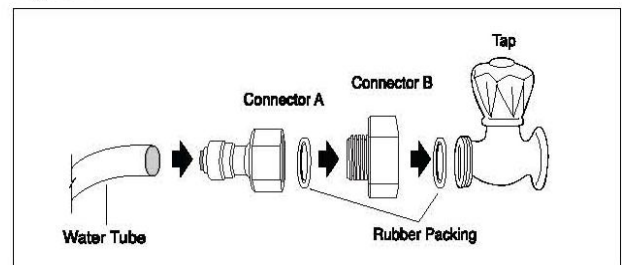
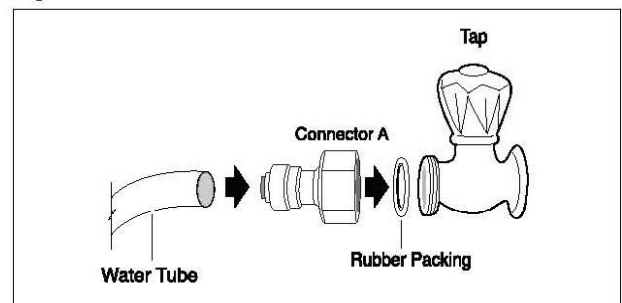

Figure B



- NB** Place the rubber washer inside the tap connector and screw onto the water tap.

2. Get ready to install the Water Filter

- Measure an approximate distance between the filter and the Water Tube and cut the tube off filter vertically.
- Connect the tubes to the filter as the figure shows.

- NB** Leave a sufficient distance when cutting the tubes.

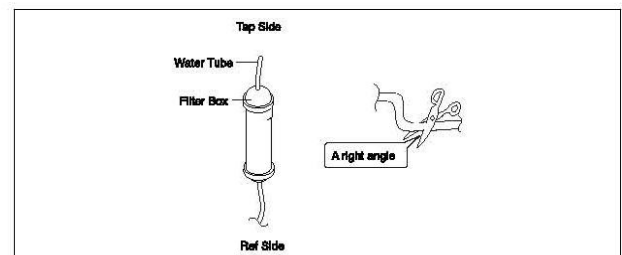

3. Remove any substances in the filter.

- 1) Open the main tap water valve and check if water comes out of the Water Tube.
- 2) Check if the Water Valve is open in case water does not come out.
- 3) Leave the valve open until clean water is coming out.
※Initial water may contain some substances out of filter (manufacturing process).

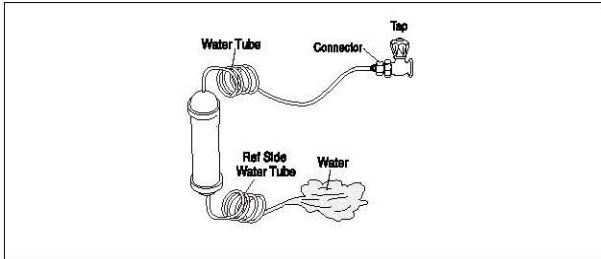

4. Attach the Filter Box

- 1) Screw and fasten the filter holder to the left/right side of the back of refrigerator.
※In case the holder is not fastened well, remove the back paper of the tape on the filter holder and attach it."
- 2) Insert the filter box into the holder.

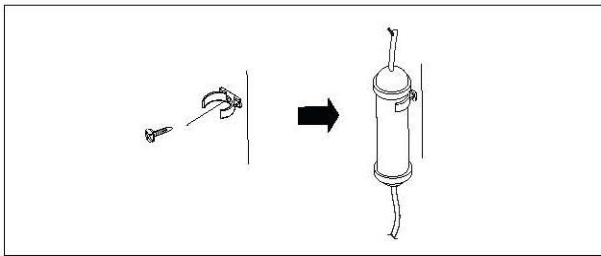

5. Connect the Water Tube to the refrigerator.

- 1) Remove the rear cover at the bottom back of the refrigerator.
- 2) Insert the fastening ring into the Water tube.
(Be careful to follow the direction of the nut.)
- 3) Insert the Water Tube into the top of the Water Valve, turn the nut clockwise to fasten it. (The Water valve is to the right of the motors.)
- 4) Check for any bent tubes or water leaks; if so, re-check installation procedure.
- 5) Replace the rear cover. (The Water Tube should be placed between the groove of the refrigerator back and motor cover.)

NE! Set the tube upright as the figure shows.

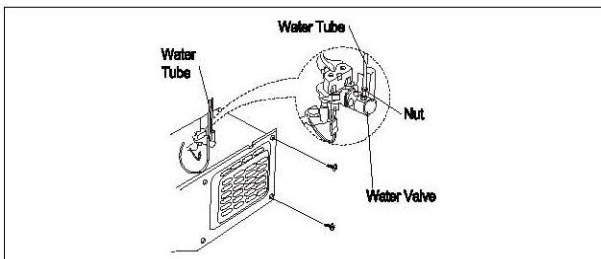

6. Fasten the Water Tube.

- 1) Fasten the Water Tube with the [Fastener A].
- 2) Check if the tube is bent or squeezed. If so, set it right to prevent any water leak.

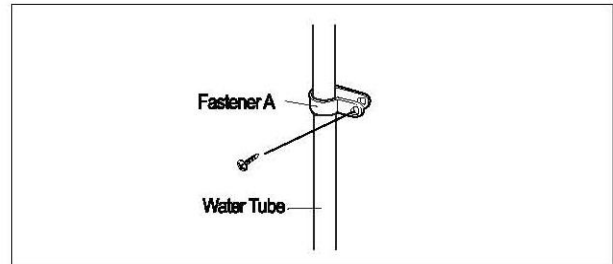

7. After installation of Water Supply System

- 1) Plug in the refrigerator, press the [WATER] button on the control panel for 2~3 minutes to remove any air (bubble) in the pipes and drain out the initial water.
- 2) Check for the water leaks again through the water supply system (tubes, connectors and pipes) Rearrange the tubes again and do not move the refrigerator.

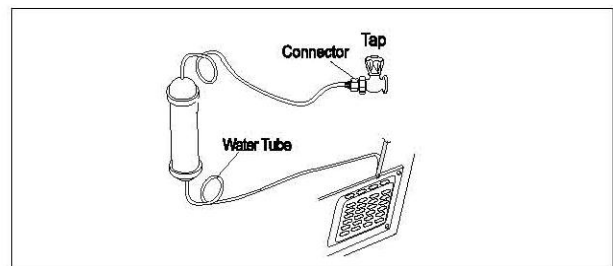

Internal Filter Type

WATER SUPPLY KIT

※Check the parts below for installing water supply.
Some other necessary parts are available at your local service agents.



Installation Procedure (Dispenser Models Only)

1. Join Connector to the tap water line

Figure A

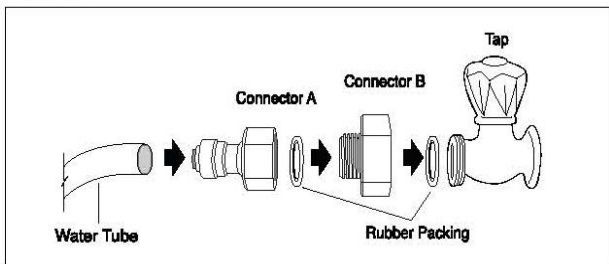
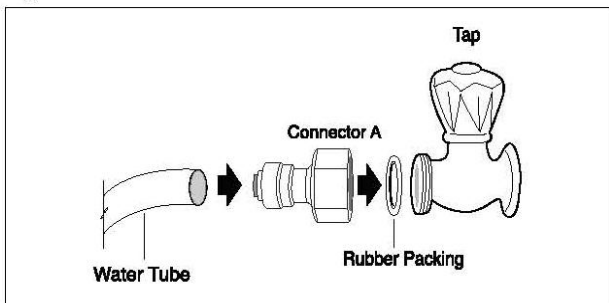

Figure B



N.B. Place the rubber washer inside the tap connector and screw onto the water tap.

2. Check Valve Connection

- 1) Cut the Water Tube connected to the tap water to a proper length.
- 2) Put the Water Tube you cut out onto the tube fixing piece of the refrigerator.



- 3) Use the check valve to connect the Water Tube.

Caution! Check valve is used to prevent backdraft and to connect the tubes. You should connect it with the water flow direction correct.



Connected water tube state

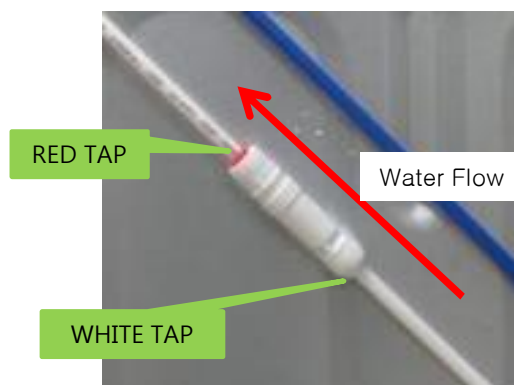

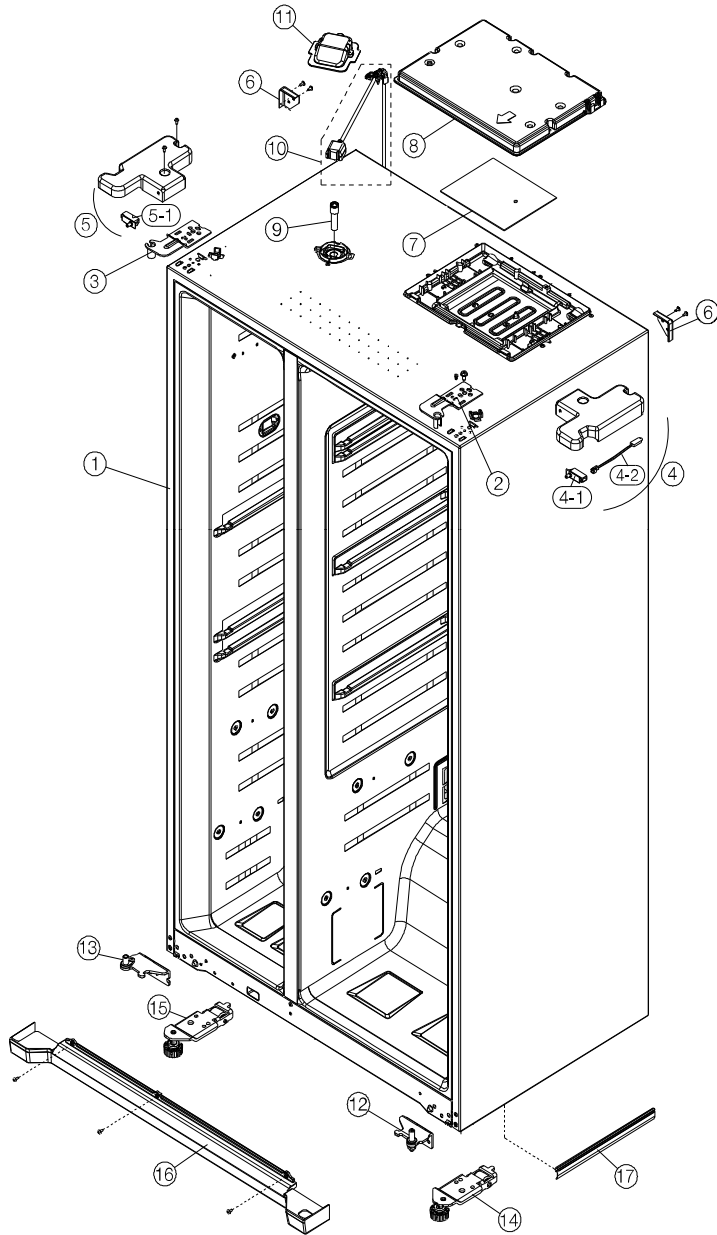

No	Part Code	Part Name	Description	Q'ty
1	-	ASSY CAB URT	-	1
2	3012933110	HINGE *T *R	PO T3.0	1
3	3012933010	HINGE *T *L	PO T3.0	1
4	3001436810	COVER HI *T *R AS	PP	1
4-1	3018125601	SWITCH H/BAR DR AS	SP101B-2D1(G) GRAY	1
4-2	3014810600	SENSOR HUMID AS	DW-HS001A	1
5	3001436700	COVER HI *T *L AS	FRX-621B	1
5-1	3018125601	SWITCH H/BAR DR AS	SP101B-2D1(G) GRAY	1
6	3010968400	CAP CAB COVER	PP	2
7	30143LG070	PCB MAIN AS	NORMAL COMP.	1
	30143LG0G0		NORMAL COMP., H/BAR	
	30143LG060		INVERTER COMP, A+, H/BAR	
	30143LG080		INVERTER COMP, A++	
	30143LG0D0	INVERTER COMP, A++, H/BAR		
	30143LG010	PCB MAIN AS [CRUSHED ICE]	NORMAL COMP.	
	30143LG0J0		NORMAL COMP., H/BAR	
	30143LG030		INVERTER COMP, A+, H/BAR	
	30143LG020		INVERTER COMP, A++	
	30143LG0L0		INVERTER COMP, A++, H/BAR	
8	300149CR00	COVER M/PCB BOX	FLAME RESISTING PP	1
9	3013227800	HOSE I/MAKER TUBE AS	FRQ-503D	1
10	3012553000	GUIDE CAB W/TUBE A AS	FRQ-503D	1
11	300149CY00	COVER GUIDE CAB W/TUBE A AS	FRQ-503D	1
12	3012933500	HINGE *U *R AS	FRX-621B	1
13	3012933400	HINGE *U *L AS	FRX-621B	1
14	3010684300	BRACKET ADJ FT *R AS	FRQ-503D	1
15	3010684200	BRACKET ADJ FT *L AS	FRQ-503D	1
16	3001433900	COVER CAB BRKT	PP	1
17	3012325810	GASKET CAB BASE	PVC	1

- Some parts can be changed for improving their performance without notice.

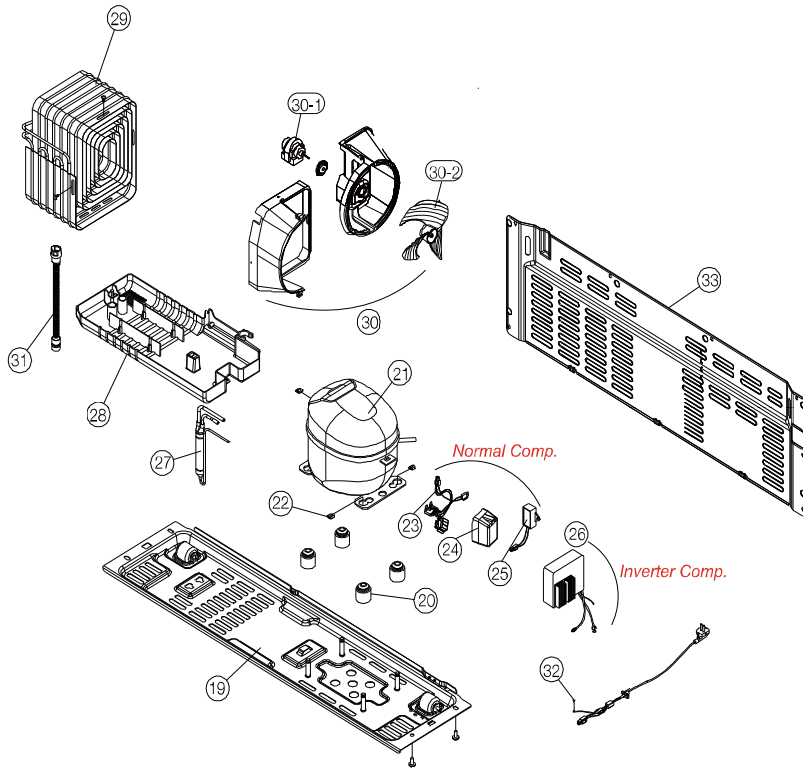

No	Part Code	Part Name	Description	Q'ty	
				Normal Comp	Inverter Comp
19	3010359600	BASE COMP AS	FRX-621B	1	
20	3010101600	ABSORBER COMP	R-134a Comp.Only	1	
	3010101480	ABSORBER COMP AS	R-600a Comp. Only		
21	3956180045	COMPRESSOR	NW80LHP4-L, 220V/60Hz[R-134a]	1	X
	3956112950		CMA121NAEM ,220-240V/50Hz[R600a]		
	39591A5290		ENV4A5G-L2B/220-240V/50,60Hz[R600a]	X	1
	3959111M70		VESD11C 230V,50HZ[R600a]		
22	3016002500	WASHER COMP	SK-5 T0.8XW22XL24.5	3	
23	3018129750	SWITCH P RELAY AS	NW80LHP4-L, 265NHB,S330	1	X
	3018135000		CMA121NAEM.4TM213SFB, 330MD2		
24	3811400503	COVER RELAY	PP(SW5101SW),NW80LHP4-L,	1	X
	3811402510		MQ98,CMA121NAEM		
25	3016402060	CAPACITOR RUN	400VAC/6 μF (WIRE, P2),NW80LHP4-L	1	X
	3016406100		400VAC/5 μF (WIRE, P2), CMA121NAEM		
26	3814300600	BOX INVERTER AS	ENV4A5G-L2B	X	1
	3010587200		VESD11C		
27	3016808100	DRYER AS	-	1	
28	3011199L00	CASE VAPORI AS	FRX-621B(PP NATURAL)	1	
29	3014461530	PIPE WICON AS	FRU-57(SBS)	1	
30	3018410500	MOUTHBELL AS	FRX-621B	1	
30-1	3015920900	MOTER C FAN	D4612AAA31	1	
30-2	3011836300	FAN	PP OD3.17*D150	1	
31	3013222900	HOSE DRN B	PE	1	
32	OPTION	CORD POWER AS	country dependent	1	
33	3001436510	COVER MACH RM AS	PCM / T0.4	1	

- Some parts can be chaged for improving their performance without notice.

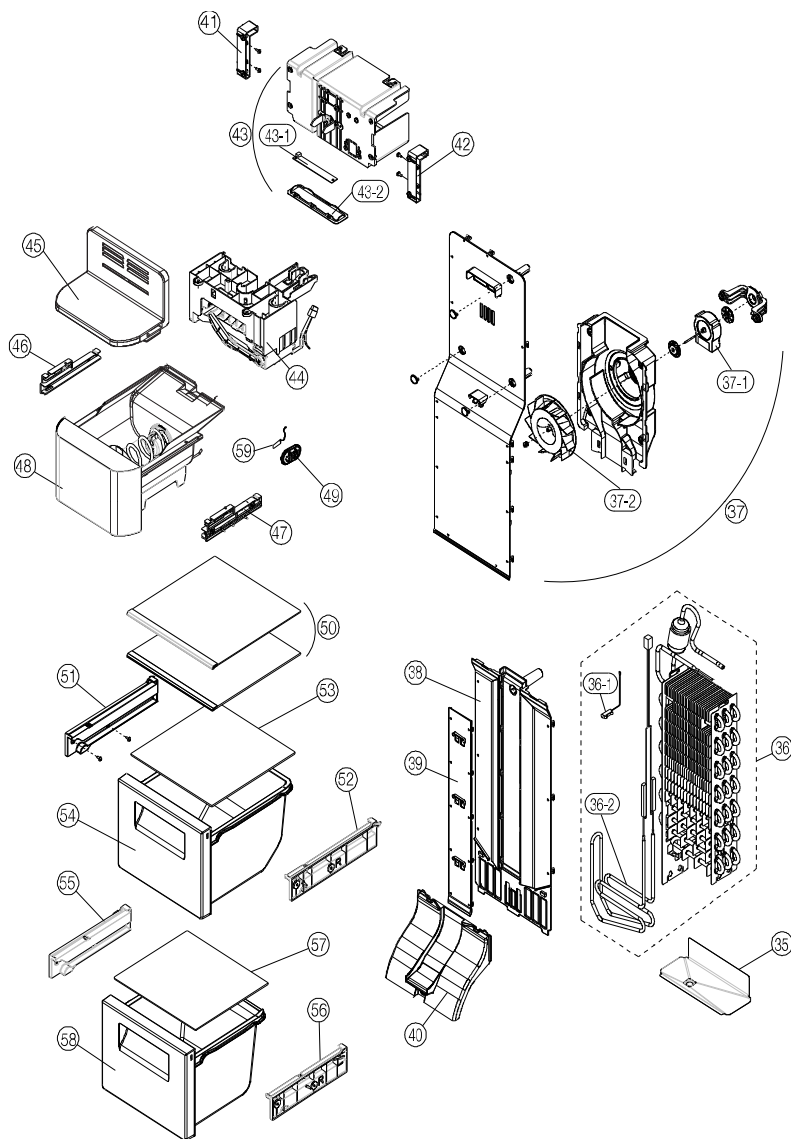

NO	PART-CODE	PART NAME	SPEC.	Q'ty
				All Models
35	3012551400	GUIDE DRN	SGCC	1
36	3017071100	EVA AS	220-240V, 250W	1
36-1	3014809500	SENSOR D AS	PBN-43	1
36-2	3012832100	HEATER SHEATH AS	220-240V, 250W	1
37	3018933900	LOUVER F A AS	FRQ-503D	1
37-1	3015920700	MOTOR F FAN AS	DL-5985DWRA	1
37-2	3011836400	FAN F	ABS	1
38	3018933800	LOUVER F B AS	-	1
39	3018933700	LOUVER F D	HIPS	1
40	300149CK00	COVER F RETURN	HIPS	1
41	3012517800	GUIDE G MOTR BRKT*L	ABS	1
42	3012517900	GUIDE G MOTR BRKT*R	ABS	1
43	3010683500	BRACKET G/MOTR AS (NORMAL)	220-240V/50Hz	1
	3010683510		220V/60Hz	
	3010683520		120V/60Hz	
43	3010683700	BRACKET G/MOTR AS (CRUSHED ICE)	220-240V/50Hz	1
	3010683710		220V/60Hz	
	3010683720		120V/60Hz	
43-1	30143LR300	PCB FRE LED AS	CEM-1.5LED	1
43-2	3015517200	WINDOW F LED *T	ABS	1
44	3012250000	FRAME I/MAKER AS	FRQ-503D	1
45	300149CM00	COVER I/CRUSHER*T	HIPS	1
46	3012552300	GUIDE I/CRUSHER *L	ABS	1
47	3012552400	GUIDE I/CRUSHER *R	ABS	1
48	301119WB00	CASE I/CRUSHER AS	NORMAL	1
	301119WC00		CRUSHED ICE	
49	300149D800	COVER SENSOR	ABS	1
50	3017863510	SHELF F A AS	FRQ-503D	2
51	3012553600	GUIDE CASE A *L AS	PP	1
52	3012553700	GUIDE CASE A *R AS	PP	1
53	3017865900	SHELF F B AS	-	1
54	301119WE00	CASE F *T AS	GPPS	1
	301119WE10		GPPS+METAL DECO [Option]	
55	3012553800	GUIDE CASE C *L AS	PP	1
56	3012553900	GUIDE CASE C *R AS	PP	1
57	3017866000	SHELF F C AS	-	1
58	301119WF00	CASE F *U AS	GPPS	1
	301119WF10		GPPS+METAL DECO [Option]	
59	3014812100	SENSOR D AS	-	1

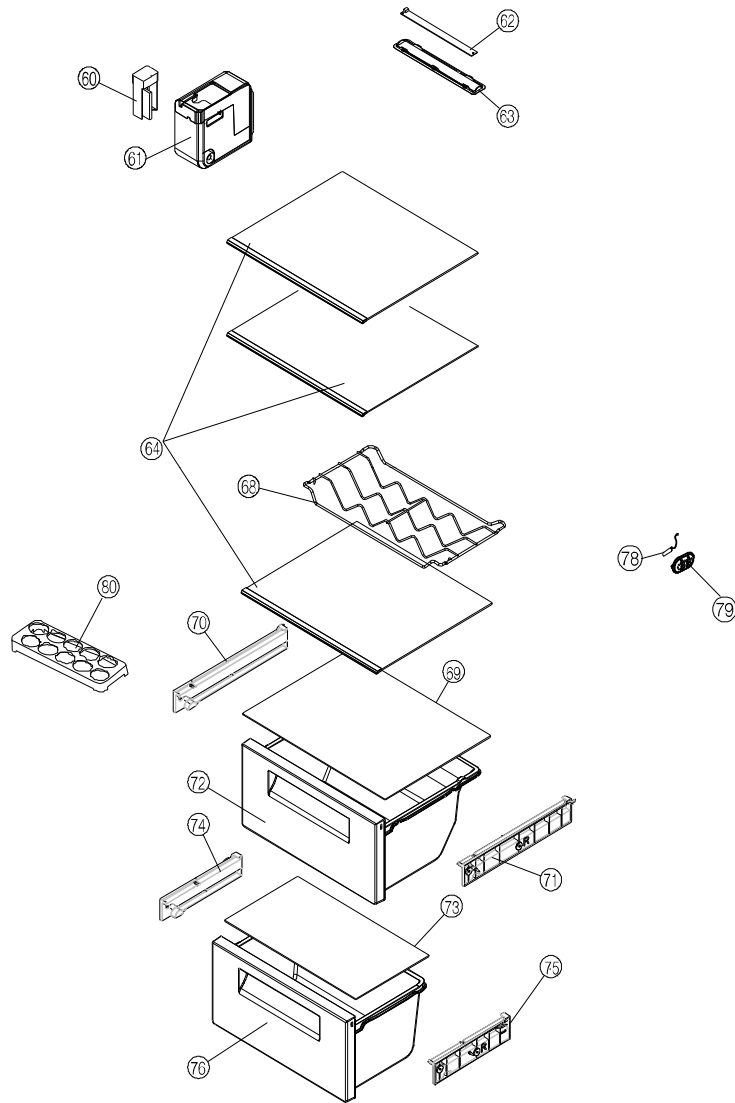

NO	PART-CODE	PART NAME	SPEC.	Q'ty
				All Models
60	3016767100	DAMPER AS	DU24-013	1
61	300149CX00	COVER DAMPER AS	FRQ-503D	1
62	30143LR400	PCB REF LED AS	CEM-1.9LED	1
63	3015517100	WINDOW R LED *T	ABS	1
64	3017863610	SHELF R A AS	-	3
68	3017865100	SHELF WINE	SUS 304[Option]	1
69	3017863300	SHELF GLAS R B	-	1
70	3012554000	GUIDE VEGETB CASE A *L AS	PP	1
71	3012554100	GUIDE VEGETB CASE A *R AS	PP	1
72	301119WG00	CASE VEGETB *T AS	GPPS	1
	301119WG10		GPPS+METAL DECO [Option]	
73	3017863400	SHELF GLAS R C	-	1
74	3012553800	GUIDE CASE C *L AS	PP	1
75	3012553900	GUIDE CASE C *R AS	PP	
76	301119WH00	CASE VEGETB *U AS	GPPS	1
	301119WH10		GPPS+METAL DECO [Option]	
77	3010580800	BOX W/PUMP AS	FPX-602	1
77-1	3018450000	PUMP DISPENSER AS	DC 12V, SANKYO	1
77-2	3018450100	PUMP I/MAKER AS	DC 12V, SANKYO	1
78	3014812200	SENSOR R AS	-	1
79	300149D800	COVER SENSOR	ABS	1
80	3011190800	CASE EGG TRAY	GPPS	1

- Some parts can be changed for improving their performance without notice.

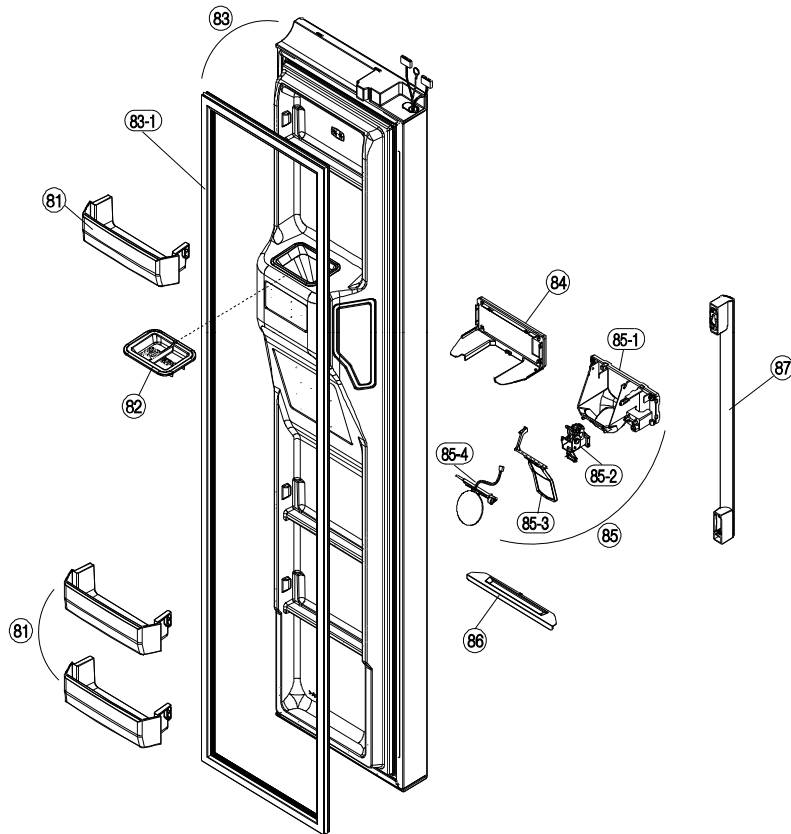

Pocket & Panel parts code.

NO	PART-CODE	PART NAME	SPEC.	Q'ty	
81	3019071300	POCKET F	GPPS	3	
	3019071600		GPPS+METAL DECO [Option]		
82	300149CP00	COVER I/PATH FRAME	HIPS	1	
84	3014258200	PANEL *F CONTL AS	NORMAL	1	x
	3014258300		CRUSHED ICE		
	3014260600		NORMAL	x	1
	3014260700		CRUSHED ICE		
85	3010585600	BOX DISPNS I/SHUT AS	FRQ-503D	1	
85-1	3010585200	BOX DISPNS I/SHUT	HIPS	1	
85-2	3015922800	MOTOR I/SHUT AS	DC12V (SCD)	1	
85-3	3013704600	LEVER DISPNS BOX	PC	1	
85-4	300149CT00	COVER ICE FLAP AS	FRQ-503D	1	
86	30124M1500	GRILL DISPNS	ABS	1	

Door & Handle parts code.

NO	PART-CODE	PART NAME	SPEC.	Q'ty
83	30100C4E00	ASSY F DR	FRQ-503D(DWH1C)	1
	30100C4E10		FRQ-503D(TSH5E)	
	30100C4E30		FRQ-503F(BLH6L)	
	30100C4E60		FRQ-503D(TSH5L)	
83-1	3012331600	GASKET F DR AS	PVC-S+MAGNET	1
	3012331620		BLACK PVC-S + MAGNET	
87	3012661000	HANDLE F DR AS	NORMAL	1
	3012661010		SPRAY	

- Some parts can be chaged for improving their performace without notice.

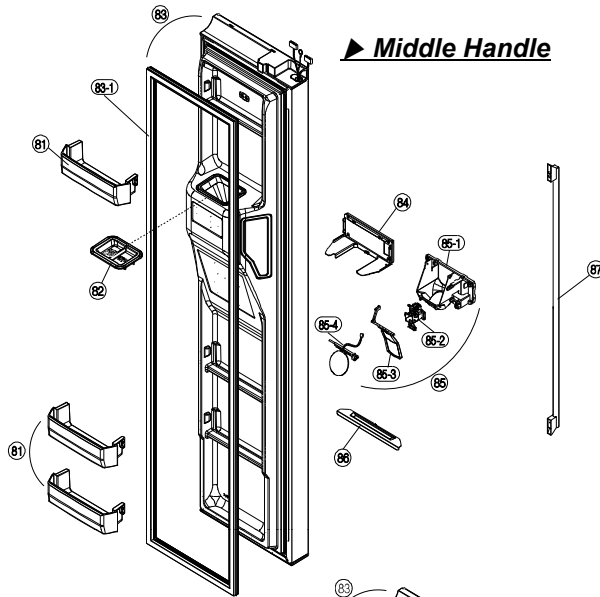

► Middle Handle

► Long Handle

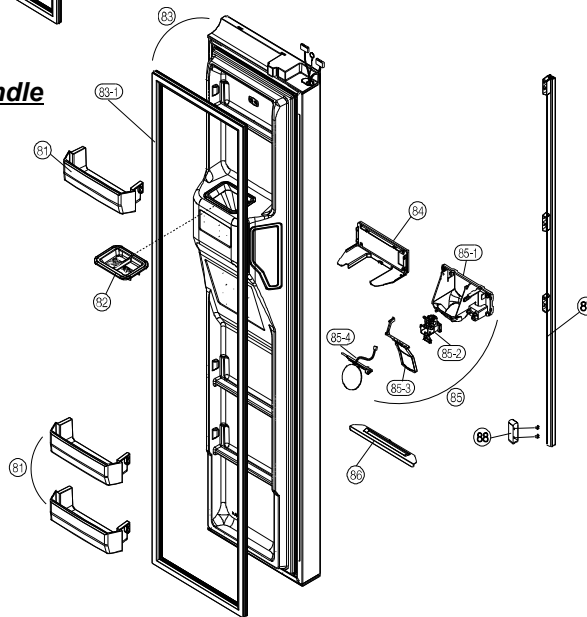

Pocket & Panel parts code.

NO	PART-CODE	PART NAME	SPEC.	Q'ty			
81	3019071300	POCKET F	GPPS	3			
	3019071600		GPPS+METAL DECO(OPTION)				
82	300149CP00	COVER I/PATH FRAME	HIPS	1			
83-1	3012331600	GASKET F DR AS	PVC-S+MAGNET	1			
	3012331620		BLACK PVC-S + MAGNET				
84	3014258200	PANEL *F CONTL AS	NORMAL	1	x		
	3014258300		CRUSHED ICE				
	3014260600		NORMAL	x	1		
	3014260700		CRUSHED ICE				
85	3010585600	BOX DISPNS I/SHUT AS	FRQ-503D	1			
85-1	3010585200	BOX DISPNS I/SHUT	HIPS				
85-2	3015922800	MOTOR I/SHUT AS	DC12V (SCD)				
85-3	3013704600	LEVER DISPNS BOX	PC				
85-4	300149CT00	COVER ICE FLAP AS	FRQ-503D				
86	30124M1500	GRILL DISPNS	ABS				

Door & Handle parts code. Middle Handle

NO	PART-CODE	PART NAME	SPEC.	Q'ty
83	30100CAJ00	ASSY F DR	FRQ-501(A), (TSH5E)	1
	30100CAJ10		FRQ-50(1,A)D(FSH2L)	
	30100CAJ20		FRQ-50(1,A)D(BLH6L)	
	30100CAJ30		FRQ-50(1,A)D(TSH5L)	
83-1	3012331600	GASKET F DR AS	PVC-S+MAGNET	1
	3012331620		BLACK PVC-S + MAGNET	
87	3012661400	HANDLE F DR AS	NORMAL	1
	3012661410		SPRAY	

Door & Handle parts code. Long Handle

NO	PART-CODE	PART NAME	SPEC.	Q'ty
83	30100C4E40	ASSY F DR	FRQ-505(E) ,(BLH6L)	1
	30100C4E50		FRQ-505(E) ,(SUS430)	
83-1	3012331600	GASKET F DR AS	PVC-S+MAGNET	1
	3012331620		BLACK PVC-S + MAGNET	
87	3012653710	HANDLE F DR AS	LONG HANDLE	1
88	3015320100	SUPPORTER F HND L *U	ABS	1

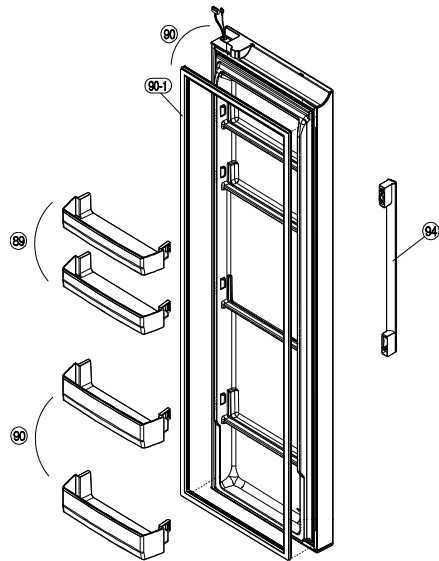

Pocket & Panel parts code.

NO	PART-CODE	PART NAME	SPEC.	Q'ty
89	3019071400	POCKET R *T	GPPS	2
	3019071700		GPPS+METAL DECO(OPTION)	
90	3019071500	POCKET R *U	GPPS	2
	3019071800		GPPS+METAL DECO(OPTION)	

Door & Handle parts code.

NO	PART-CODE	PART NAME	SPEC.	Q'ty
90	30100C4G00	ASSY R DR	FRQ-503(C), (DWH1C)	1
	30100C4G10		FRQ-503(C), (TSH5E)	
	30100C4G50		FRQ-503(C), (TSH5L)	
90-1	3012331700	GASKET R DR AS	PVC-S+MAGNET	1
	3012331720		BLACK PVC-S + MAGNET	
94	3012661100	HANDLE R DR AS	NORMAL	1
	3012661110		SPRAY	

►H/bar Model

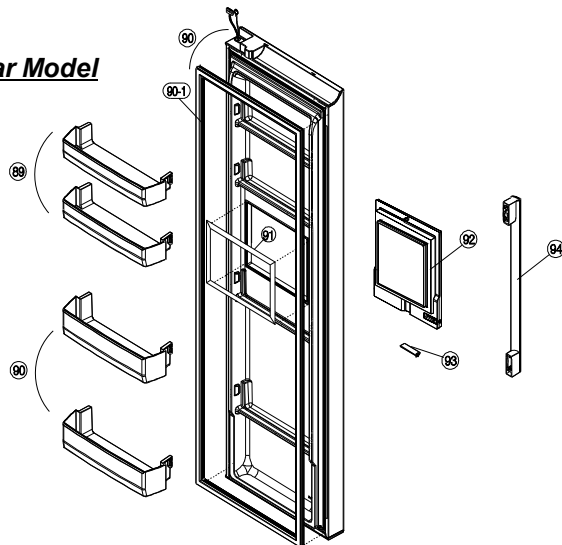

Door & Handle parts code. (H/bar Model)

NO	PART-CODE	PART NAME	SPEC.	Q'ty
90	30100C4J00	ASSY R DR	FRQ-503(C), (DWH1C)	1
	30100C4J10		FRQ-503(C), (BLH6L)	
	30100C4J20		FRQ-503(C), (TSH5E)	
90-1	3012331700	GASKET R DR AS	PVC-S+MAGNET	1
	3012331720		BLACK PVC-S + MAGNET	
91	3012326200	GASKET H/BAR B AS	-	1
92	3001707720	DOOR H/BAR AS	TITANIUM	1
	3001707730		WHITE	
93	3001432800	COVER H/BAR HI BRKT	ABS	1
94	3012661100	HANDLE R DR AS	FRN-Q19*3	1
	3012661110		FRN-Q19*C	

- Some parts can be chaged for improving their performace without notice.

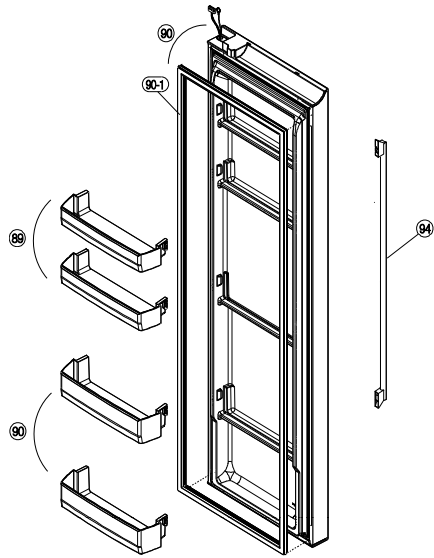

Pocket & Panel parts code.

NO	PART-CODE	PART NAME	SPEC.	Q'ty
89	3019071400	POCKET R *T	GPPS	2
	3019071700		GPPS+METAL DECO(OPTION)	
90	3019071500	POCKET R *U	GPPS	2
	3019071800		GPPS+METAL DECO(OPTION)	

Door & Handle parts code.

NO	PART-CODE	PART NAME	SPEC.	Q'ty
90	30100C5A800	ASSY R DR	FRQ-501(A), (DWH1C)	1
	30100CAK00		FRQ-501(A), (TSH5E)	
	30100CAK10		FRQ-501(A), (TSH5L)	
90-1	3012331700	GASKET R DR AS	PVC-S+MAGNET	1
	3012331720		BLACK PVC-S + MAGNET	
94	3012661500	HANDLE R DR AS	FRN-Q19*1 Only	1
	3012661510		FRN-Q19*A Only _(SPRAY)	

► H/bar Model

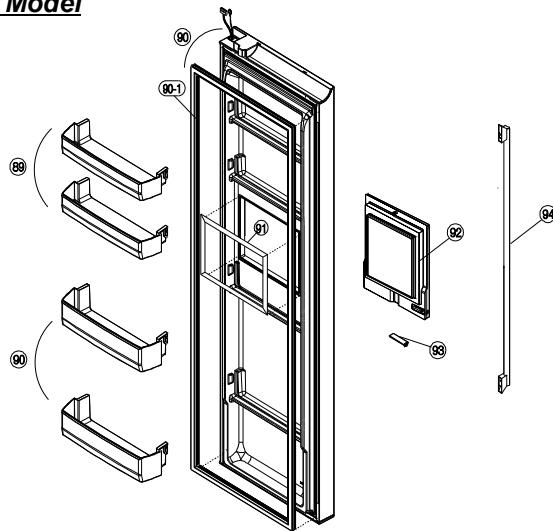

Door & Handle parts code. (H/bar Model)

NO	PART-CODE	PART NAME	SPEC.	Q'ty
90	30100C5A00	ASSY R DR	FRQ-501(A), (DWH1C)	1
	30100CAD00		FRQ-501(A), (TSH5E)	
90-1	3012331700	GASKET R DR AS	PVC-S+MAGNET	1
	3012331720		BLACK PVC-S + MAGNET	
91	3012326200	GASKET H/BAR B AS	-	1
92	3001707720	DOOR H/BAR AS	TITANIUM	1
	3001707730		WHITE	
93	3001432800	COVER H/BAR HI BRKT	ABS	1
94	3012661500	HANDLE R DR AS	FRN-Q19*1 Only	1
	3012661510		FRN-Q19*A Only _(SPRAY)	

- Some parts can be chaged for improving their performance without notice.

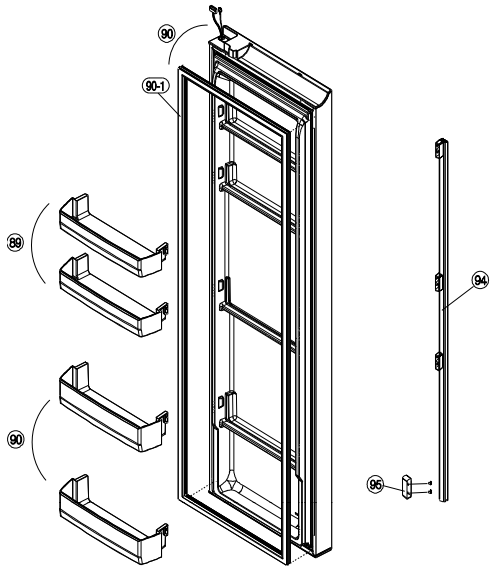

► **H/bar Model**

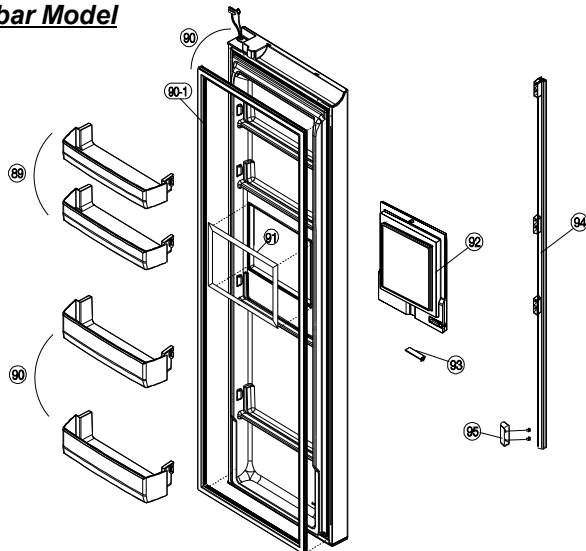

Pocket & Panel parts code.

NO	PART-CODE	PART NAME	SPEC.	Q'ty
89	3019071400	POCKET R *T	GPPS	2
	3019071700		GPPS+METAL DECO(OPTION)	
90	3019071500	POCKET R *U	GPPS	2
	3019071800		GPPS+METAL DECO(OPTION)	

Door & Handle parts code.

NO	PART-CODE	PART NAME	SPEC.	Q'ty
90	30100C4G20	ASSY R DR	FRQ-505(E), (FSH2L)	1
	30100C4G30		FRQ-501(A), (BLH6L)	
	30100C4G40		FRQ-501(A), (SUS430)	
90-1	3012331700	GASKET R DR AS	PVC-S+MAGNET	1
	3012331720		BLACK PVC-S + MAGNET	
94	3012653610	HANDLE R DR AS	LONG HANDLE ,X600	1
95	3015319700	SUPPORTER R HND L *U	ABS	

Door & Handle parts code. (H/bar Model)

NO	PART-CODE	PART NAME	SPEC.	Q'ty
90	30100C4J10	ASSY R DR	FRQ-505(E), (FSH2L)	1
	30100C4J40		FRQ-505(E), (SUS430)	
90-1	3012331700	GASKET R DR AS	PVC-S+MAGNET	1
	3012331720		BLACK PVC-S + MAGNET	
91	3012326200	GASKET H/BAR B AS	-	1
92	3001707720	DOOR H/BAR AS	TITANIUM	1
	3001707730		WHITE	
93	3001432800	COVER H/BAR HI BRKT	ABS	1
94	3012653610	HANDLE R DR AS	LONG HANDLE ,X600	1
95	3015319700	SUPPORTER R HND L *U	ABS	

- Some parts can be chaged for improving their performace without notice.