

ML1.542

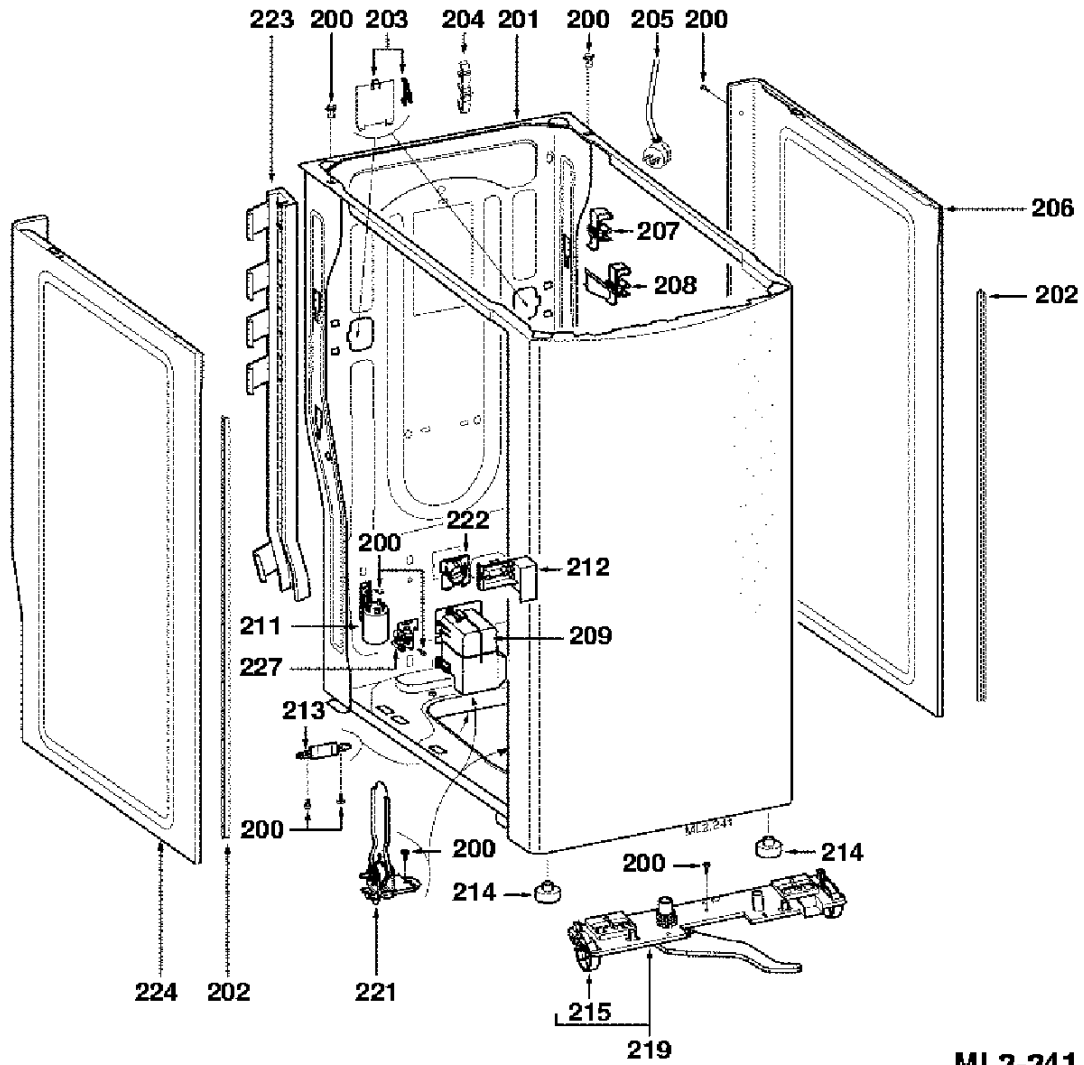

ML2-241

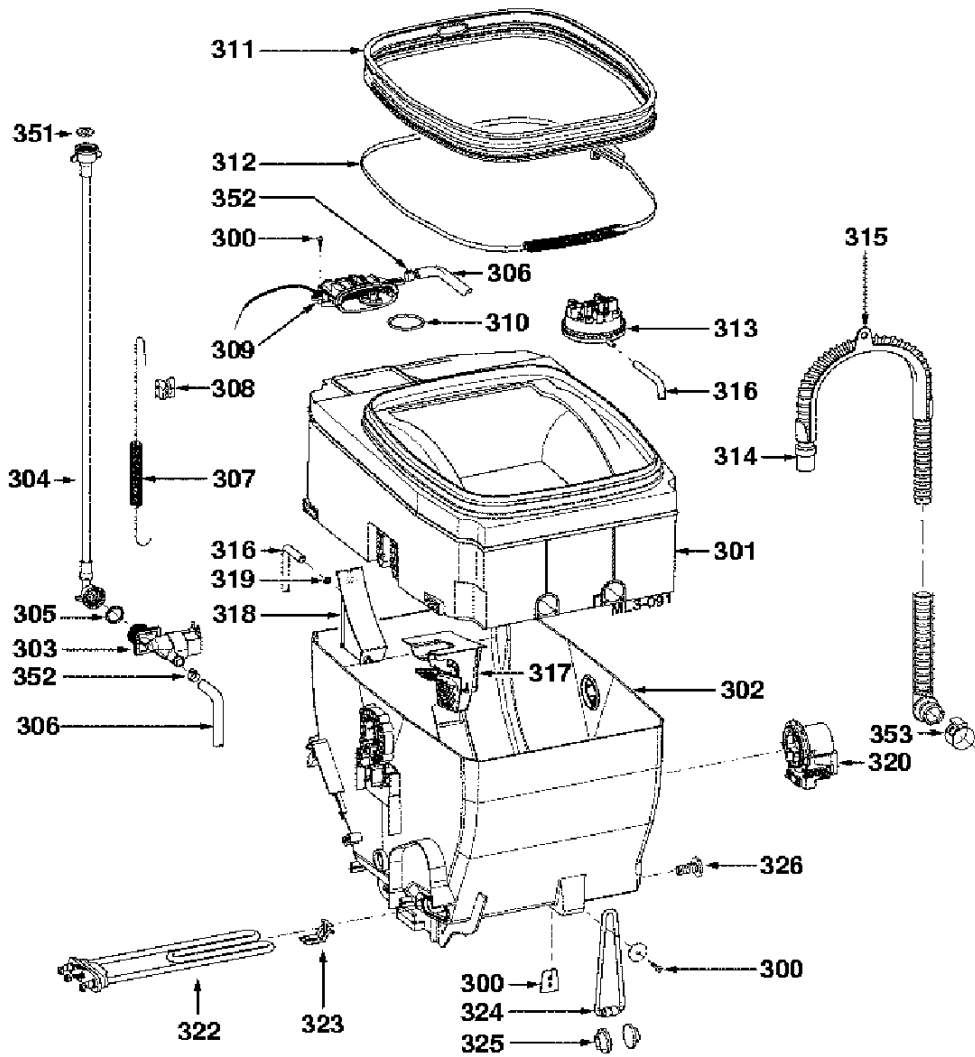

ML3-091

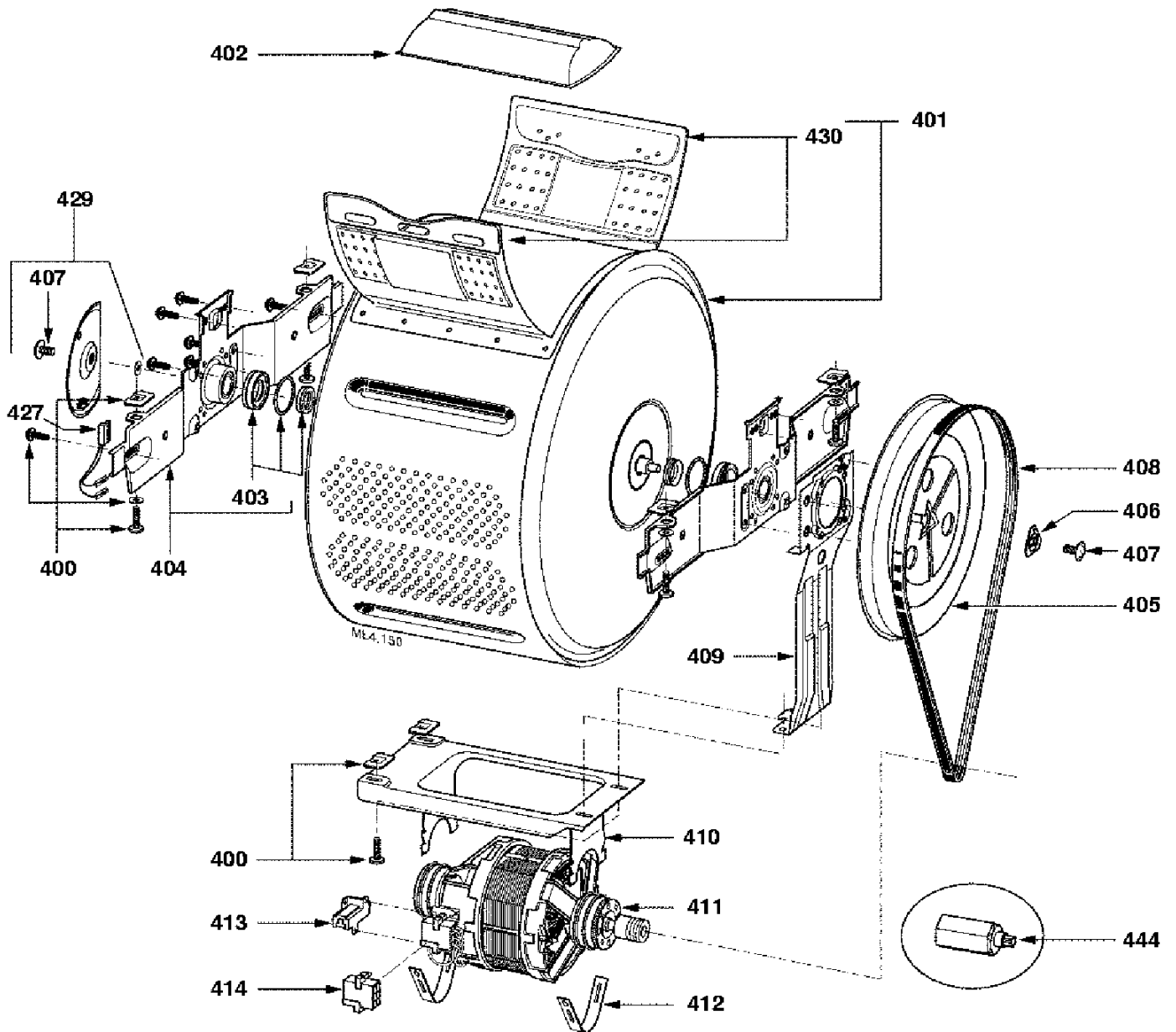

ML4-150